

# Operating Manual

Translation of the original operating manual

## KB 23 / KB 23-UL (E3.1)

### Cooling Incubators

with compressor technology and program control

Model	Model version	Art. No.
KB 23 (E3.1)	KB023-230V	9020-0112, 9120-0112
KB 23-UL (E3.1)	KB023UL-115V	9020-0113, 9120-0113

## **BINDER GmbH**

- ▶ Address: Post office box 102, 78502 Tuttlingen, Germany ▶ Phone: +49 7462 2005 0
- ▶ Fax: +49 7462 2005 100 ▶ Internet: <http://www.binder-world.com>
- ▶ E-mail: [info@binder-world.com](mailto:info@binder-world.com) ▶ Service Hotline: +49 7462 2005 555
- ▶ Service Fax: +49 7462 2005 93 555 ▶ Service E-Mail: [service@binder-world.com](mailto:service@binder-world.com)
- ▶ Service Hotline USA: +1 866 885 9794 or +1 631 224 4340 x3
- ▶ Service Hotline Asia Pacific: +852 390 705 04 or +852 390 705 03
- ▶ Service Hotline Russia and CIS: +7 495 988 15 16

---

## Contents

<b>1. SAFETY</b> .....	<b>4</b>
1.1 Legal considerations .....	4
1.2 Structure of the safety instructions .....	4
1.2.1 Signal word panel.....	4
1.2.2 Safety alert symbol.....	5
1.2.3 Pictograms .....	5
1.2.4 Word message panel structure.....	6
1.3 Localization / position of safety labels on the chamber .....	6
1.4 Type plate.....	7
1.5 General safety instructions on installing and operating the chambers .....	8
1.6 Intended use.....	10
1.7 Operating instructions .....	11
1.8 Measures to prevent accidents .....	11
<b>2. CHAMBER DESCRIPTION</b> .....	<b>12</b>
2.1 Chamber overview .....	13
2.2 Control panel .....	13
2.3 Chamber rear .....	14
<b>3. COMPLETENESS OF DELIVERY, TRANSPORTATION, STORAGE, AND INSTALLATION</b> .....	<b>14</b>
3.1 Unpacking, and checking equipment and completeness of delivery.....	14
3.2 Guidelines for safe lifting and transportation .....	15
3.3 Storage.....	15
3.4 Location of installation and ambient conditions.....	16
<b>4. ELECTRICAL CONNECTION</b> .....	<b>17</b>
<b>5. START UP</b> .....	<b>18</b>
5.1 Settings at the RD3 program controller.....	18
5.2 General indications.....	19
<b>6. FIXED VALUE ENTRY MODE</b> .....	<b>20</b>
<b>7. WEEK PROGRAM EDITOR</b> .....	<b>22</b>
7.1 Program table template for Week program Editor .....	24
<b>8. PROGRAM EDITOR</b> .....	<b>25</b>
8.1 Selecting between set-point ramp and set-point step .....	25
8.1.1 Programming with setting “Ramp” (default setting) .....	25
8.1.2 Programming with setting “step” .....	27
8.1.3 General notes on programming of temperature transitions .....	28
8.2 Set-point entry for program operation .....	28
8.3 Program table template for Program Editor .....	32
8.4 Deleting a program section .....	33
<b>9. PROGRAM START LEVEL</b> .....	<b>34</b>
<b>10. USER LEVEL</b> .....	<b>37</b>
<b>11. PROGRAMMING EXAMPLE OF THE WEEK PROGRAM EDITOR</b> .....	<b>44</b>
11.1 Desired time function .....	44
11.2 Proceeding overview .....	44
11.3 Proceeding in detail.....	45

---



<b>12. PROGRAMMING EXAMPLE OF THE PROGRAM EDITOR.....</b>	<b>51</b>
12.1 Desired time function .....	51
12.2 Proceeding overview .....	51
12.3 Proceeding in detail.....	52
<b>13. PERFORMANCE IN CASE OF FAILURES.....</b>	<b>58</b>
13.1 Performance after a power failure.....	58
13.2 Alarm messages .....	58
<b>14. TEMPERATURE SAFETY DEVICES .....</b>	<b>58</b>
14.1 Over temperature protective device (class 1) .....	58
14.2 Safety controller (temperature safety device class 3.1) .....	58
<b>15. DEFROSTING DURING REFRIGERATING OPERATION.....</b>	<b>59</b>
<b>16. OPTIONS.....</b>	<b>60</b>
16.1 APT-COM™ 4 Multi Management Software (option) .....	60
16.2 Data logger kit (option) .....	60
<b>17. MAINTENANCE, CLEANING, AND SERVICE.....</b>	<b>61</b>
17.1 Maintenance intervals, service .....	61
17.2 Cleaning and decontamination.....	62
17.2.1 Cleaning.....	62
17.2.2 Decontamination .....	63
17.3 Sending the chamber back to BINDER GmbH .....	64
<b>18. DISPOSAL.....</b>	<b>65</b>
18.1 Disposal of the transport packing.....	65
18.2 Decommissioning.....	65
18.3 Disposal of the chamber in the Federal Republic of Germany.....	65
18.4 Disposal of the chamber in the member states of the EC except for the Federal Republic of Germany.....	66
18.5 Disposal of the chamber in non-member states of the EC .....	68
<b>19. TROUBLESHOOTING .....</b>	<b>69</b>
<b>20. TECHNICAL DESCRIPTION.....</b>	<b>71</b>
20.1 Factory calibration and adjustment .....	71
20.2 Over current protection.....	71
20.3 Definition of usable volume .....	71
20.4 KB 23 / KB 23-UL (E3.1) technical data .....	72
20.5 Equipment and Options (extract) .....	73
20.6 Spare parts and accessories (extract) .....	74
20.7 KB / KB-UL 23 dimensions.....	75
<b>21. CERTIFICATES AND DECLARATIONS OF CONFORMITY .....</b>	<b>76</b>
21.1 EU Declaration of Conformity.....	76
21.2 Certificate for the GS mark of conformity of the “Deutsche Gesetzliche Unfallversicherung e.V.“ (German Social Accident Insurance) DGUV .....	79
<b>22. PRODUCT REGISTRATION .....</b>	<b>81</b>
<b>23. CONTAMINATION CLEARANCE CERTIFICATE.....</b>	<b>82</b>
23.1 For chambers located outside USA and Canada.....	82
23.2 For chambers in USA and Canada .....	85

Dear customer,

For the correct operation of the chambers, it is important that you read this operating manual completely and carefully and observe all instructions as indicated. Observe the national regulations on minimum age of laboratory personnel. Failure to read, understand and follow the instructions may result in personal injury. It can also lead to damage to the chamber and/or poor equipment performance.

## 1. Safety

This operating manual is part of the components of delivery. Always keep it handy for reference. The device should only be operated by laboratory personnel especially trained for this purpose and familiar with all precautionary measures required for working in a laboratory. To avoid injuries and damage observe the safety instructions of the operating manual.

	 <b>WARNING</b>
<p><b>Failure to observe the safety instructions.</b> <b>Serious injuries and chamber damage.</b></p> <ul style="list-style-type: none"><li>➤ Observe the safety instructions in this operating manual.</li><li>➤ Carefully read the complete operating instructions of the chambers.</li></ul>	

### 1.1 Legal considerations

This operating manual is for informational purposes only. It contains information for installing, start-up, operation and maintenance of the product. Note: the contents and the product described are subject to change without notice.

Understanding and observing the instructions in this operating manual are prerequisites for hazard-free use and safety during operation and maintenance. In no event shall BINDER be held liable for any damages, direct or incidental arising out of or related to the use of this manual.

This operating manual cannot cover all conceivable applications. If you would like additional information, or if special problems arise that are not sufficiently addressed in this manual, please ask your dealer or contact us directly by phone at the number located on page one of this manual

Furthermore, we emphasize that the contents of this operating manual are not part of an earlier or existing agreement, description, or legal relationship, nor do they modify such a relationship. All obligations on the part of BINDER derive from the respective purchase contract, which also contains the entire and exclusively valid statement of warranty administration. The statements in this manual neither augment nor restrict the contractual warranty provisions.

### 1.2 Structure of the safety instructions

In this operating manual, the following safety definitions and symbols indicate dangerous situations following the harmonization of ISO 3864-2 and ANSI Z535.6.

#### 1.2.1 Signal word panel

Depending on the probability of serious consequences, potential dangers are identified with a signal word, the corresponding safety color, and if appropriate, the safety alert symbol.

 <b>DANGER</b>
Indicates an imminently hazardous situation that, if not avoided, will result in death or serious (irreversible) injury.

**WARNING**

Indicates a potentially hazardous situation which, if not avoided, could result in death or serious (irreversible) injury.

**CAUTION**

Indicates a potentially hazardous situation which, if not avoided, may result in moderate or minor (reversible) injury.

**CAUTION**

Indicates a potentially hazardous situation which, if not avoided, may result in damage to the product and/or its functions or of a property in its proximity.

### 1.2.2 Safety alert symbol



Use of the safety alert symbol indicates a **risk of injury**.

Observe all measures that are marked with the safety alert symbol in order to avoid death or injury.

### 1.2.3 Pictograms

Warning signs			
Electrical hazard	Hot surface	Explosive atmosphere	Stability hazard
Lifting hazard	Risk of corrosion and / or chemical burns	Risk of cuts	Harmful substances
Biohazard	Pollution Hazard		
Mandatory action signs			
Mandatory regulation	Read operating instructions	Disconnect the power plug	Lift with several persons
Environment protection	Wear protective gloves	Wear safety goggles	

Prohibition signs			
Do NOT touch	Do NOT spray with water	Do NOT climb	

	<b>Information</b> to be observed in order to ensure optimum function of the product.
--	---------------------------------------------------------------------------------------

### 1.2.4 Word message panel structure

<p><b>Type / cause of hazard.</b></p> <p><b>Possible consequences.</b></p> <p>Ø Instruction how to avoid the hazard: prohibition</p> <p>➤ Instruction how to avoid the hazard: mandatory action</p>
-----------------------------------------------------------------------------------------------------------------------------------------------------------------------------------------------------

Observe all other notes and information not necessarily emphasized in the same way, in order to avoid disruptions that could result in direct or indirect injury or property damage.

### 1.3 Localization / position of safety labels on the chamber

The following labels are located on the chamber:

Pictograms (Warning signs)	
	<p>Hot surface</p> <ul style="list-style-type: none"> <li>• Inner glass door above the glass door handle</li> </ul>
	<p>Risk of cuts</p> <ul style="list-style-type: none"> <li>• Rear wall of the interior</li> </ul>
	<p>Read operating manual</p> <ul style="list-style-type: none"> <li>• UL chambers: outer chamber door</li> <li>• KB with optional interior socket: below the interior socket</li> </ul>
Service label	

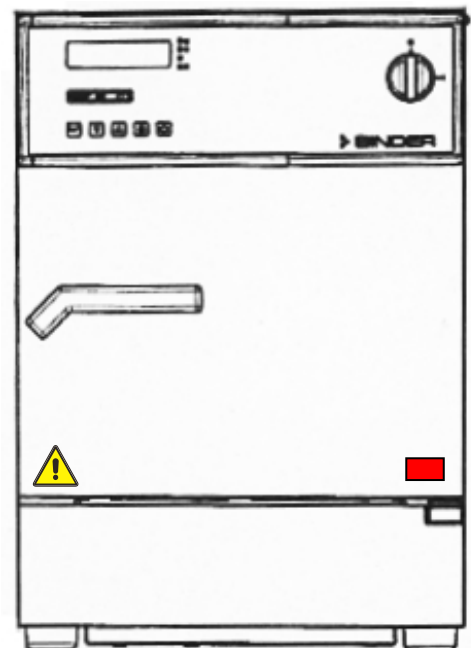

Figure 1: Position of labels on the chamber (example KB 23-UL)

	Keep safety labels complete and legible.
--	------------------------------------------

Replace safety labels that are no longer legible. Contact BINDER Service for these replacements.

## 1.4 Type plate



The type plate is located behind the outer door, bottom left-hand.

Nominal temp.	100 °C 212 °F	0,34 kW / 1,5 A 230 V / 50 Hz	 		Max. operating pressure 15 bar R 134A – 0,075 kg Contains fluorinated greenhouse gases covered by the Kyoto Protocol
IP protection	20		 		
Safety device	DIN 12880	1 N ~			
Class	3.1				
Art. No.	9020-0112				
Project No.		Cooling incubator			
Built	2019				
	BINDER GmbH Im Mittleren Ösch 5 78532 Tuttlingen / Germany www.binder-world.com			<b>KB 23</b> <b>E3.1</b>	<b>Serial No. 0000000000000</b> Made in Germany

Figure 2: Type plate (example of KB 23 (230 V) regular chamber)

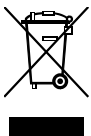
Indications of the type plate (example)		Information
BINDER		Manufacturer: BINDER GmbH
KB 23		Model designation
Cooling incubator		Device name
Serial No.	000000000000	Serial no. of the chamber
Built	2019	Year of construction
Nominal temperature	100 °C 212°F	Nominal temperature
IP protection	20	IP type of protection acc. to standard EN 60529
Temp. safety device	DIN 12880	Temperature safety device acc. to standard DIN 12880:2007
Class	3.1	Class of temperature safety device
Art. No.	9020-0112	Art. no. of the chamber
Project No.	---	Optional: Special application acc. to project no.
0,34 kW		Nominal power
1,5 A		Nominal current
230 V / 50 Hz		Nominal voltage +/-10% at the indicated power frequency
1 N ~		Current type
Max. operating pressure 15 bar		Max. operating pressure in the refrigerating system
R 134A - 0,075 kg		Refrigerant type and max. filling weight
Contains fluorinated greenhouse gases covered by the Kyoto Protocol		Contains fluorinated greenhouse gases covered by the Kyoto Protocol

Symbol on the type plate	Information
	CE conformity marking
	Electrical and electronic equipment manufactured / placed on the market in the EC after 13 August 2005 and to be disposed of in separate collection according to directive 2012/19/EU on waste electrical and electronic equipment (WEEE).

Symbol on the type plate	Information
	GS mark of conformity of the “Deutsche Gesetzliche Unfallversicherung e.V. (DGUV), Prüf- und Zertifizierungsstelle Nahrungsmittel und Verpackung im DGUV Test“ (German Social Accident Insurance (DGUV), Testing and Certification Body for Foodstuffs and Packaging Industry in DGUV Test). (Not valid for UL chambers)
	The chamber is certified according to Customs Union Technical Regulation (CU TR) for the Eurasian Economic Union (Russia, Belarus, Armenia, Kazakhstan Kyrgyzstan).
 (KB-UL only)	The chamber is certified by Underwriters Laboratories Inc.® according to standards CAN/CSA-C22.2 No. 61010-1, 2 <sup>nd</sup> Edition, 2004-07 (Electrical Equipment for Measurement, Control, and Laboratory Use; Part 1: General Requirements); UL 61010-1, 2 <sup>nd</sup> Edition, 2005-07-22 (Electrical Equipment for Measurement, Control, and Laboratory Use; Part 1: General Requirements); IEC 61010-1:2001, 2 <sup>nd</sup> Edition and IEC 61010-2-10 (Particular Requirements for Laboratory Equipment for the heating of materials).

## 1.5 General safety instructions on installing and operating the chambers



With regard to operating the chambers and to the installation location, please observe the DGUV guidelines 213-850 on safe working in laboratories (formerly BGI/GUV-I 850-0, BGR/GUV-R 120 or ZH 1/119, issued by the employers' liability insurance association) (for Germany).

BINDER GmbH is only responsible for the safety features of the chamber provided skilled electricians or qualified personnel authorized by BINDER perform all maintenance and repair, and if components relating to chamber safety are replaced in the event of failure with original spare parts.

To operate the chamber, use only original BINDER accessories or accessories from third-party suppliers authorized by BINDER. The user is responsible for any risk caused by using unauthorized accessories.



	<b>CAUTION</b>
	<p><b>Danger of overheating.</b>  <b>Damage to the chamber.</b></p> <ul style="list-style-type: none"> <li>⊘ Do NOT install the chamber in unventilated recesses.</li> <li>➤ Ensure sufficient ventilation for dispersal of the heat.</li> </ul>

Do not operate the chambers in hazardous locations.

	 <b>DANGER</b>
	<p><b>Explosion hazard.</b>  <b>Danger of death.</b></p> <ul style="list-style-type: none"> <li>⊘ Do NOT operate the chamber in potentially explosive areas.</li> <li>➤ KEEP explosive dust or air-solvent mixtures AWAY from the chamber.</li> </ul>



The chambers do not dispose of any measures of explosion protection.

	 <b>DANGER</b>
	<p><b>Explosion hazard.</b> <b>Danger of death.</b></p> <ul style="list-style-type: none"> <li>⊘ Do NOT introduce any substance into the cooling incubator which is combustible or explosive at working temperature.</li> <li>⊘ NO explosive dust or air-solvent mixture in the inner chamber.</li> </ul>



Any solvent contained in the charging material must not be explosive or inflammable. I.e., irrespective of the solvent concentration in the steam room, NO explosive mixture with air must form. The temperature inside the chamber must lie below the flash point or below the sublimation point of the charging material. Familiarize yourself with the physical and chemical properties of the charging material, as well as the contained moisture constituent and its behavior with the addition of heat energy.



Familiarize yourself with any potential health risks caused by the charging material, the contained moisture constituent or by reaction products which may arise during the temperature process. Take adequate measures to exclude such risks prior to putting the cooling incubator into operation.



	 <b>DANGER</b>
	<p><b>Electrical hazard.</b> <b>Danger of death.</b></p> <ul style="list-style-type: none"> <li>⊘ The chamber must NOT become wet during operation or maintenance.</li> </ul>

The cooling incubators were produced in accordance with VDE regulations and were routinely tested in accordance to VDE 0411-1 (IEC 61010-1).

During and shortly after operation, the temperature of the inner surfaces almost equals the set-point.

	 <b>CAUTION</b>
	<p><b>The glass doors, the glass door handles, and the inner chamber will become hot during operation.</b></p> <p><b>Danger of burning.</b></p> <ul style="list-style-type: none"> <li>⊘ Do NOT touch the glass doors, the glass door handles, the inner surfaces or the charging material during operation.</li> </ul>

	 <b>CAUTION</b>
	<p><b>Fan grid on the rear wall of the interior.</b></p> <p><b>Risk of cuts.</b></p> <ul style="list-style-type: none"> <li>⊘ Do NOT touch the rear wall of the interior during fan operation.</li> </ul>

 	 <b>WARNING</b>
	<p><b>Stability hazard.</b></p> <p><b>Danger of injury.</b></p> <p><b>Damage to the chamber and the charging material.</b></p> <p><b>Housing cover breakaway.</b></p> <ul style="list-style-type: none"> <li>∅ Do NOT climb on the lower housing cover.</li> <li>∅ Do NOT load the lower housing cover with heavy objects while the chamber door is open.</li> </ul>

## 1.6 Intended use



Cooling incubators KB / KB-UL are suitable for exact conditioning of harmless materials. Because of their precise temperature accuracy these devices are especially useful for cultivation of microorganisms with a narrow temperature optimum in a range of 4 °C / 39.2°F to 37 °C / 98.6°F. Main fields of application are tests of long-term storage (e.g. at 4 °C / 39.2°F), refrigerated incubation between 20 °C / 68°F and 25 °C / 77°F and incubation at 37 °C / 98.6°F (also with additional introduction of heat) or with alternating temperatures (e.g. 37 °C / 98.6°F and 4 °C / 39.2°F).

A mixture of any component of the charging material with air must NOT be explosive. The operating temperature must lie below the flash point or below the sublimation point of the charging material. Any component of the charging material must NOT be able to release toxic gases.

**Other applications are not approved.**

**The chambers are not classified as medical devices as defined by the Medical Device Directive 93/42/EEC.**

	<p>Following the instructions in this operating manual and conducting regular maintenance work (chap. 17.1) are part of the intended use.</p>
-------------------------------------------------------------------------------------	-----------------------------------------------------------------------------------------------------------------------------------------------

 	 <b>DANGER</b>
	<p><b>Explosion or implosion hazard.</b></p> <p><b>Danger of poisoning.</b></p> <p><b>Danger of death.</b></p> <ul style="list-style-type: none"> <li>∅ Do NOT introduce any substance combustible or explosive at working temperature into the chamber, in particular no energy sources such as batteries or lithium-ion batteries.</li> <li>∅ NO explosive dust or air-solvent mixture in the inner chamber.</li> <li>∅ Do NOT introduce any substance which could lead to release of toxic gases.</li> </ul>

	<p>The charging material shall not contain any corrosive ingredients that may damage the machine components made of stainless steel, aluminum, and copper. Such ingredients include in particular acids and halides. Any corrosive damage caused by such ingredients is excluded from liability by BINDER GmbH.</p>
-------------------------------------------------------------------------------------	---------------------------------------------------------------------------------------------------------------------------------------------------------------------------------------------------------------------------------------------------------------------------------------------------------------------

	<p><b>WARNING:</b> If customer should use a BINDER chamber running in non-supervised continuous operation, we strongly recommend in case of inclusion of irrecoverable specimen or samples to split such specimen or samples and store them in at least two chambers, if this is feasible.</p>
-------------------------------------------------------------------------------------	------------------------------------------------------------------------------------------------------------------------------------------------------------------------------------------------------------------------------------------------------------------------------------------------

In case of foreseeable use of the chamber there is no risk for the user through the integration of the chamber into systems or by special environmental or operating conditions in the sense of EN 61010-1:2010. For this, the intended use of the chamber and all its connections must be observed.

## 1.7 Operating instructions

Depending on the application and location of the chamber, the operator of the chamber must provide the relevant information for safe operation of the chamber in a set of operating instructions.



Keep these operating instructions with the chamber at all times in a place where they are clearly visible. They must be comprehensible and written in the language of the employees.

## 1.8 Measures to prevent accidents

The operator of the chamber must observe the following rule: “Betreiben von Arbeitsmitteln. Betreiben von Kälteanlagen, Wärmepumpen und Kühleinrichtungen“ (Operation of work equipment. Operation of refrigeration systems, heat pumps and refrigeration equipment) (GUV-R 500 chap. 2.35) (for Germany).

The manufacturer took the following measures to prevent ignition and explosions:

- **Indications on the type plate**  
See operating manual chap. 1.4.
- **Operating manual**  
An operating manual is available for each chamber.
- **Overtemperature monitoring**  
The chamber is equipped with a temperature display, which can be read from outside.  
The chamber is equipped with an additional safety controller (temperature safety device class 3.1 acc. to DIN 12880:2007). Visual and audible (buzzer) signals indicate temperature exceeding.
- **Safety, measurement, and control equipment**  
The safety, measuring, and control equipment is easily accessible.
- **Electrostatic charge**  
The interior parts are grounded.
- **Non-ionizing radiation**  
Non-ionizing radiation is not intentionally produced, but released only for technical reasons by electrical equipment (e.g. electric motors, power cables, solenoids). The machine has no permanent magnets. If persons with active implants (e.g. pacemakers, defibrillators) keep a safe distance (distance of field source to implant) of 30 cm, an influence of these implants can be excluded with high probability.
- **Protection against touchable surfaces**  
Tested according to EN ISO 13732-1:2008.
- **Floors**  
See operating manual chap. 3.4 for correct installation
- **Cleaning**  
See operating manual chap. 17.2.

- **Examinations**

The chamber has been inspected by the “Deutsche Gesetzliche Unfallversicherung e.V. (DGUV) (German Social Accident Insurance (DGUV))” (German Social Accident Insurance (DGUV), Testing and Certification Body for Foodstuffs and Packaging Industry in DGUV Test) and bears the GS mark. (Not valid for UL chambers)

UL chambers only: The chamber is certified by Underwriters Laboratories Inc.® according to the standards CAN/CSA-C22.2 No. 61010-1, 2<sup>nd</sup> Edition, 2004-07; UL 61010-1, 2<sup>nd</sup> Edition, 2005-07-22; IEC 61010-1:2001, 2<sup>nd</sup> Edition and IEC 61010-2-10.

## 2. Chamber description

A high level of precision, reliability, and safety for all growth parameters ensures optimum incubation conditions. Moreover, the KB / KB-UL cooling incubator is designed for maximum usability – even in continuous operation year after year. It fulfills all technical and application-specific requirements arising in experimentation such as in the areas of biotechnology, medicine, the nutrition industry, pharmaceutical and cosmetics industries, botany, and zoology.

Two important temperature technologies have been combined to achieve perfect temperature control. The specially developed DCT™ refrigerating system, a direct refrigerating process, in conjunction with the APT.line™ preheating chamber technology, satisfies the unique prerequisites for attaining highly-precise temperature control and particularly short recovery times after opening the door.

The refrigerating system is distinguished by direct, precise, and rapid temperature conduction. Large-area labyrinth evaporator plates directly conduct the cold to the atmosphere of the working space.

The APT.line™ preheating chamber system ensures high level of spatial and time-based temperature precision, thanks to the direct and distributed air circulation into the interior. This is especially important for maintaining temperatures – especially with full chambers – and for rapid restoration of optimum growth conditions after opening the door. The inner glass door ensures that the temperature remains constant when observing the incubation process. The fan supports exact attainment and maintenance of the desired temperature accuracy. The fan speed is digitally adjustable. The heating and refrigerating systems are microprocessor regulated to a tenth of a degree. In addition, the chamber provides almost unlimited possibilities for adaptation to individual customer requirements based upon extensive programming options and on the week program timer and real time clock of the controller.

All chamber functions are easy and comfortable to use thanks to their clear arrangement. Major features are easy cleaning of all chamber parts and avoidance of undesired contamination.

The inner chamber, the pre-heating chamber and the interior side of the doors are all made of stainless steel V2A (German material no. 1.4301, US equivalent AISI 304). The housing is RAL 7035 powder-coated. All corners and edges are also completely coated.

The chamber comes equipped with a serial interface RS 422 for computer communication, e.g. via the APT-COM™ 4 Multi Management Software (option, chap. 16.1).

Temperature range at ambient temperature of 25 °C / 77 °F: -5 °C / 23 °F up to +100 °C / 212 °F

## 2.1 Chamber overview

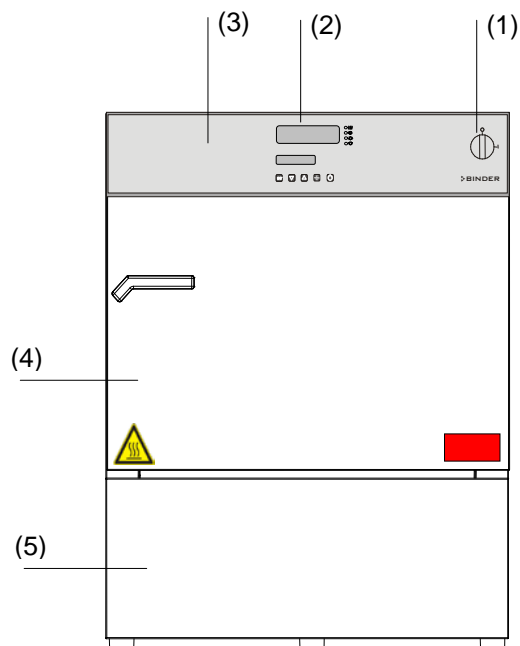

Figure 3: Cooling incubator KB 23

- (1) Main power switch on/off
- (2) Temperature controller RD3
- (3) Instrument box
- (4) Chamber door
- (5) Refrigerating module

## 2.2 Control panel

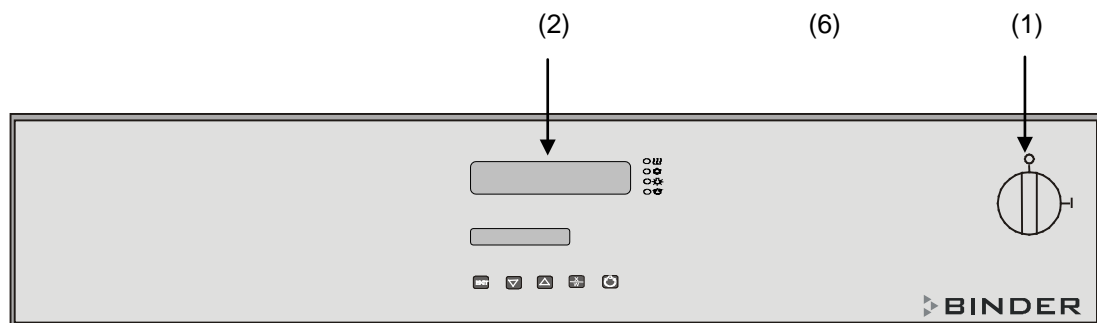

Figure 4: Control panel

- (1) Main power switch on/off
- (2) Program controller RD3

## 2.3 Chamber rear

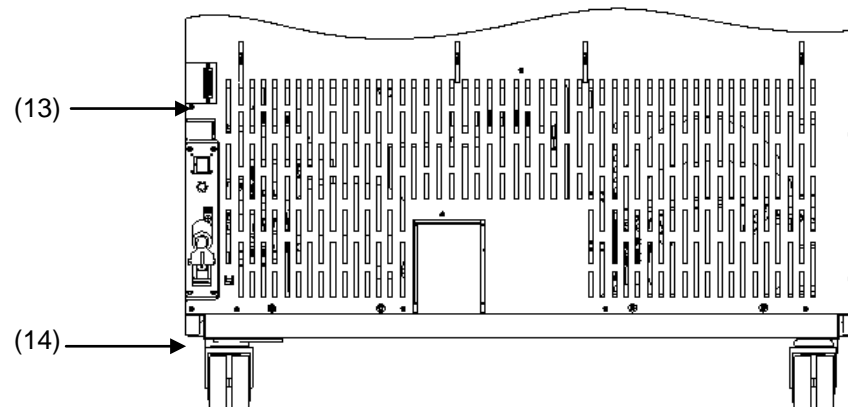

Figure 5: Chamber rear with position of RS 422 interface

(13) Interface RS 422 for computer communication

(14) Power cable





## 3. Completeness of delivery, transportation, storage, and installation

### 3.1 Unpacking, and checking equipment and completeness of delivery

After unpacking, please check the chamber and its optional accessories, if any, based on the delivery receipt for completeness and for transportation damage. Inform the carrier immediately if transportation damage has occurred.

The final tests of the manufacturer may have caused traces of the shelves on the inner surfaces. This has no impact on the function and performance of the chamber.

Please remove any transportation protection devices and adhesives in/on the chamber and on the doors and remove the operating manuals and accessory equipment.

  	 <b>CAUTION</b>
	<p><b>Sliding or tilting of the chamber.</b>  <b>Damage to the chamber.</b>  <b>Risk of injury by lifting heavy loads.</b></p> <p>⊘ Do NOT lift or transport the chamber using the door, the handle, or the lower housing.          ➤ Lift the chambers from the pallet with the aid of two people in the area of all 4 chamber feet.</p>

If you need to return the chamber, please use the original packing and observe the guidelines for safe lifting and transportation (chap. 3.2).

For disposal of the transport packing, see chap. 18.1.





**Note on second-hand chambers (Ex-Demo-Units):**

Second-hand chambers are chambers that were used for a short time for tests or exhibitions. They are thoroughly tested before resale. BINDER ensures that the chamber is technically sound and will work flawlessly.

Second-hand chambers are marked with a sticker on the chamber door. Please remove the sticker before commissioning the chamber.

### 3.2 Guidelines for safe lifting and transportation

After operation, please observe the guidelines for temporarily decommissioning the chamber (chap. 18.2).

  	 <b>CAUTION</b>
	<p><b>Sliding or tilting of the chamber.</b></p> <p><b>Damage to the chamber.</b></p> <p><b>Risk of injury by lifting heavy loads.</b></p> <ul style="list-style-type: none"> <li>➤ Transport the chamber in its original packaging only.</li> <li>➤ For moving or shipping, secure the chamber with transport straps.</li> <li>⊘ Do NOT lift or transport the chamber using the door, the handle, or the lower housing.</li> <li>➤ Lift the chambers with the aid of two people in the area of all 4 chamber feet.</li> </ul>

- Permissible ambient temperature range during transport: -10 °C / 14 °F to +60 °C / 140 °F.

You can order transport packing for moving or shipping purposes from BINDER service.

### 3.3 Storage

Intermediate storage of the chamber is possible in a closed and dry room. Observe the guidelines for temporary decommissioning (chap. 18.2).

- Permissible ambient temperature range during storage: -10 °C / 14 °F to +60 °C / 140 °F.
- Permissible ambient humidity: max. 70 % r.h., non-condensing

When after storage in a cold location you transfer the chamber to its warmer installation site, condensation may form. Before start-up, wait at least one hour until the chamber has attained ambient temperature and is completely dry.

### 3.4 Location of installation and ambient conditions

Set up the chamber on a flat, even surface, free from vibration, in a well-ventilated, dry location and align it using a spirit level. The site of installation must be capable of supporting the chamber's weight (see technical data, chap. 20.4 and 20.5). The chambers are designed for setting up inside a building (indoor use).

	<b>CAUTION</b>
	<p><b>Danger of overheating.</b>  <b>Damage to the chamber.</b></p> <ul style="list-style-type: none"> <li>∅ Do NOT set up chambers in non-ventilated recesses.</li> <li>➤ Ensure sufficient ventilation for dispersal of the heat.</li> </ul>

- Permissible ambient temperature range during operation: +18 °C / 64.4 °F to +32 °C / 89.6 °F. At elevated ambient temperature values, fluctuations in temperature can occur.

	<p>The ambient temperature should not be substantially higher than the indicated ambient temperature of +22 °C +/- 3 °C / 71.6 °F ± 5.4 °F to which the specified technical data relates. Deviations from the indicated data are possible for other ambient conditions.</p>
-----------------------------------------------------------------------------------	-----------------------------------------------------------------------------------------------------------------------------------------------------------------------------------------------------------------------------------------------------------------------------

	<p>With each degree of ambient temperature &gt; +25 °C / 77°F, the refrigeration power decreases by 1.5 K.</p>
-----------------------------------------------------------------------------------	----------------------------------------------------------------------------------------------------------------

- Permissible ambient humidity: 70 % r.H. max., non-condensing.

When operating the chamber at temperature set-points below ambient temperature, high ambient humidity may lead to condensation on the chamber.

- Installation height: max. 2000 m / 6562 ft. above sea level.

When placing several chambers of the same size side by side, maintain a minimum distance of 250 mm / 9.84 in between each chamber. Wall distances: rear 100 mm / 3.94 in, sides 160 mm / 6.29 in. Spacing above the chamber of at least 100 mm / 3.94 in must also be maintained.

Two chambers of the same size can be piled on top of each other. For this purpose place rubber pads under every foot of the upper chamber to prevent the device from slipping.

	<b>CAUTION</b>
	<p><b>Sliding or tilting of the upper chamber.</b>  <b>Damage to the chambers.</b></p> <ul style="list-style-type: none"> <li>➤ When stacking, place rubber pads under every foot of the upper chamber.</li> <li>➤ Stack only chambers of the same size.</li> </ul>

To completely separate the chamber from the power supply, you must disconnect the power plug. Install the chamber in a way that the power plug is easily accessible and can be easily pulled in case of danger.



For the user there is no risk of temporary overvoltages in the sense of EN 61010-1:2010.

With an increased amount of dust in the ambient air, clean the condenser fan (by suction or blowing) several times a year.

Avoid any conductive dust in the ambiance according to the chamber layout complying with pollution degree 2 (IEC 61010-1).



Do not install or operate the chamber in potentially explosive areas.

	 <b>DANGER</b>
	<p><b>Explosion hazard.</b> <b>Danger of death.</b></p> <ul style="list-style-type: none"> <li>⊘ Do NOT operate the chamber in potentially explosive areas.</li> <li>➤ KEEP explosive dust or air-solvent mixtures AWAY from the vicinity of the chamber.</li> </ul>

## 4. Electrical connection

The chambers are supplied ready for connection. They come with a fixed power connection cable of at least 1800 mm / 70.87 in in length. They are equipped with a semi time-lag fine-wire fuse.

Model	Power plug	Nominal voltage $\pm 10\%$ at the indicated power frequency	Current type	Chamber fuse
KB 23 (E3.1)	Shock-proof plug	230 V at 50 Hz	1N~	10 A
KB 23-UL (E3.1)	NEMA 5-15	115 V at 60 Hz	1N~	12.5 A

- The domestic socket must also provide a protective conductor. Make sure that the connection of the protective conductor of the domestic installations to the chamber's protective conductor meets the latest technology. The protective conductors of the socket and plug must be compatible!
- Prior to connection and start-up, check the power supply voltage. Compare the values to the specified data located on the chamber's type plate (left chamber side, bottom right-hand, see chap. 1.4).
- When connecting, please observe the regulations specified by the local electricity supply company as well as the VDE directives (for Germany). We recommend the use of a residual current circuit breaker.
- Pollution degree (acc. to IEC 61010-1): 2
- Over-voltage category (acc. to IEC 61010-1): II

	<b>CAUTION</b>
	<p><b>Danger of incorrect power supply voltage.</b> <b>Damage to the equipment.</b></p> <ul style="list-style-type: none"> <li>➤ Check the power supply voltage before connection and start-up.</li> <li>➤ Compare the power supply voltage with the data indicated on the type plate.</li> </ul>

See also electrical data (chap. 20.4).

	<p>To completely separate the chamber from the power supply, you must disconnect the power plug. Install the chamber in a way that the power plug is easily accessible and can be easily pulled in case of danger.</p>
-------------------------------------------------------------------------------------	------------------------------------------------------------------------------------------------------------------------------------------------------------------------------------------------------------------------

## 5. Start up

After connecting the electrical supply (chap. 4.1), turn on the chamber by the main power switch (1).

Warming chambers may release odors in the first few days after commissioning. This is not a quality defect. To reduce odors quickly we recommend heating up the chamber to its nominal temperature for one day and in a well-ventilated location.



**WARNING:** If customer should use a BINDER chamber running in non-supervised continuous operation, we strongly recommend in case of inclusion of irrecoverable specimen or samples to split such specimen or samples and store them in at least two chambers, if this is feasible.

### 5.1 Settings at the RD3 program controller

After turning the chamber on with the main power switch (1) the controller is in Normal Display / Fixed value operation mode.

Depending on the temperature value entered before, LED (3a) is lit if the heating is active, or LED (3b) if the refrigeration is active, or no LED if the actual temperature is equal to the set-point.

In **Display 1** of the controller the actual temperature value is shown.

- With inactive week program timer:

In **Display 2** of the controller the actual date and time are displayed. Example:

15.05.14 13:52

- With active week program timer:

In **Display 2** of the controller the actual date and time and the states of the week program timer channels are displayed. Examples:

15.05.14 13:52 - -

Channel 1 Off,  
Channel 2: Off

15.05.14 13:52 - □

Channel 1: Off,  
Channel 2: On

15.05.14 13:52 □ -

Channel 1: On,  
Channel 2: Off

15.05.14 13:52 □ □

Channel 1 On,  
Channel 2: On

Display 1

Display 2



- ☹ (3a) LED Heating active
- ⚙ (3b) LED Refrigeration active
- (no function)
- ↻ (3d)  
LED illuminates: program operation  
LED flashes: exceeding of the tolerance limits in Fixed value entry mode or in Program operation. In program operation: program interruption.

Figure 6: RD3 program controller

The program controller RD3 permits programming of temperature cycles. For each program section also the fan speed can be regulated.

Two programs with up to 10 sections each or one program with up to 20 sections can be entered (setting in the user level, chap. 10).



When changing from 2 programs to 1 program or vice-versa, existing programs are deleted

The maximum length of an individual program section can be set to either 99 hs 59 min or to 999 hs 59 min (setting in the user level, chap. 10). This setting is then valid for all program sections.

Programming can be done directly via the controller keyboard or graphically at the computer using APT-COM™ 4 Multi Management Software (option, chap. 16.1) specially developed by BINDER.

## 5.2 General indications

The program controller RD3 offers several functional levels:

### Normal Display / fixed value operation:

- Display of the actual value of temperature (display 1) and of the actual date and time (display 2).
- The chamber is in fixed value operating mode, equilibrating to the entered set-points.

### Fixed value entry mode (chap. 6)

- Entry of set-points for temperature, fan speed, and the safety controller for fixed value operating mode
- Entry of temperature set-points SP 1 and SP 2 for week program operation

### Program editor (chap. 8)

- Two programs with up to 10 sections each or one program with up to 20 sections can be entered (selection in the user level, chap. 10). Entry of set-points for temperature and fan speed in all program sections (chap. 8.2).
- Deleting a program section (chap. 8.4)

### Program start level (chap. 9)

- Selection of an entered program
- Entry of settings affecting the program course, as “start delay time” or “number of program cycles”
- Program start

### Week program editor (chap.7)

- Setting the shift points

### User level (chap. 10)

- User specific controller settings
- Setting the real time clock

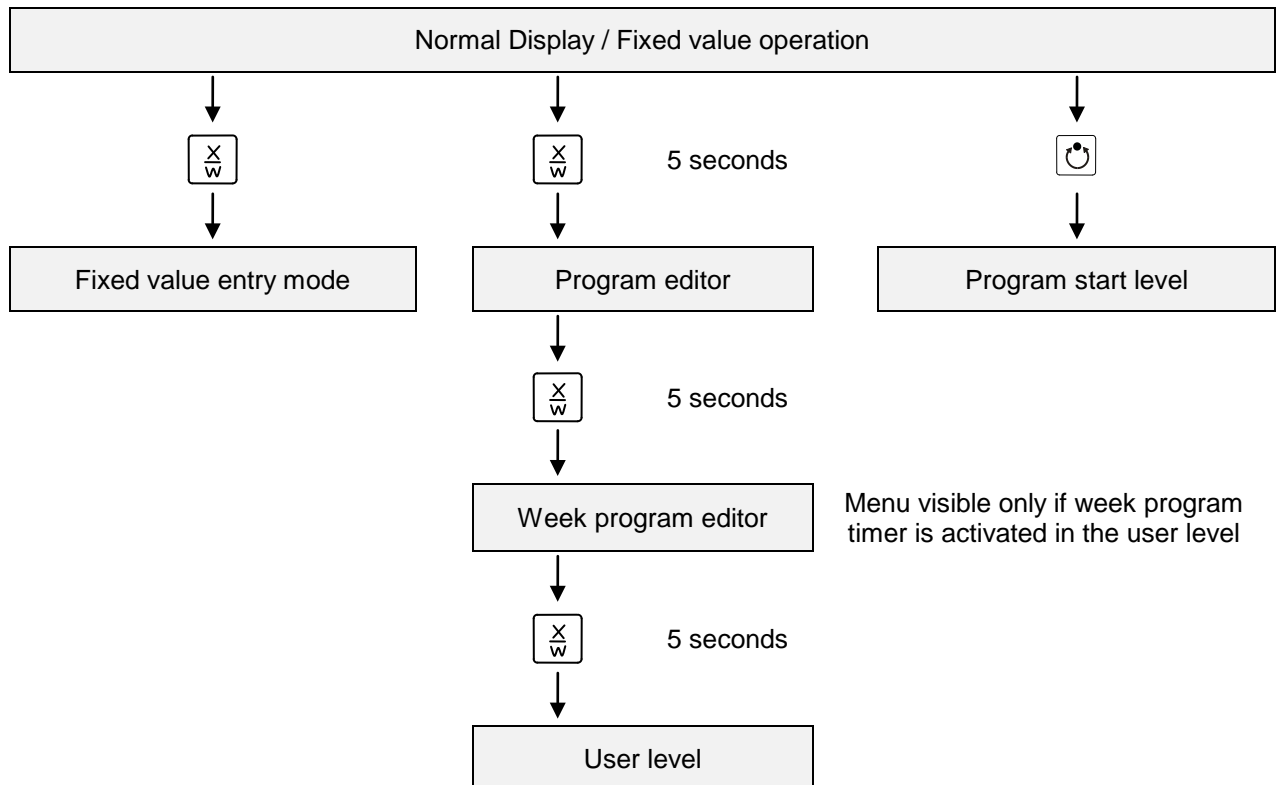

If no button is touched within more than 120 sec. the controller returns from the current level to Normal Display.

## 6. Fixed value entry mode



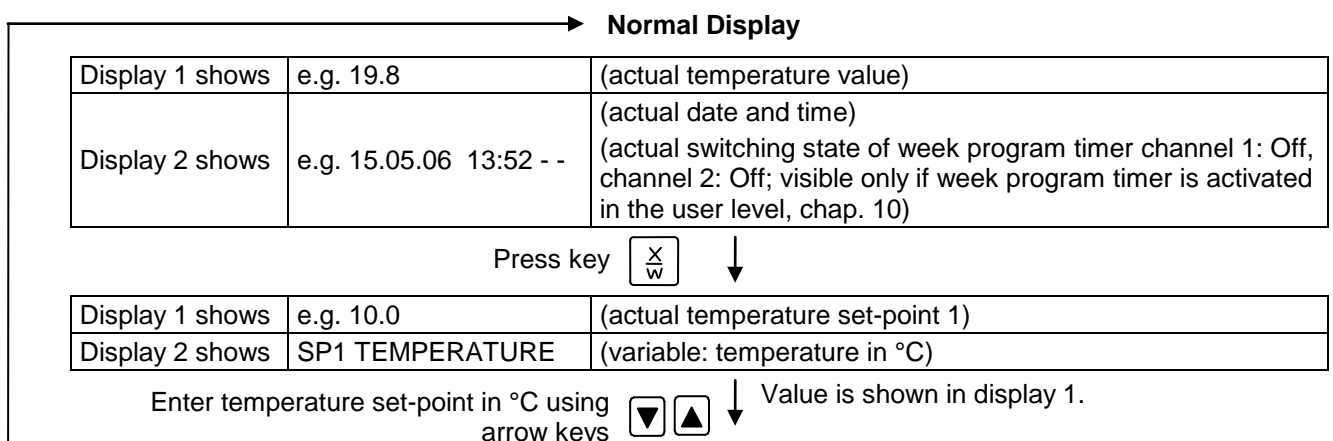

If you do not want to use the week program timer, deactivate it (factory setting, setting in the user level, chap. 10) before entering any set-points. Any setting of the operation lines in Fixed value entry mode is ineffective with an active week program timer.

**Basic entry principle:** Access the individual parameters with button X/W one after the other. Enter the values with the arrow keys. A value flashing once after 2 seconds indicates that it has been applied by the controller.





Press key  ↓

Display 1 shows	e.g. 37.0	(actual temperature set-point 2) (visible only if week program timer is activated in the user level, chap. 10)
Display 2 shows	SP2 TEMPERATURE	(variable: temperature in °C)

Enter temperature set-point in °C using arrow keys   ↓ Value is shown in display 1.

Press key  ↓



Display 1 shows	e.g. 100	(actual fan speed set-point)
Display 2 shows	SP FAN SPEED	(variable: fan speed in %)

Enter fan speed set-point in % using arrow keys   ↓ Value is shown in display 1.



Press key  ↓

Only with option zero-voltage relay outputs via operation lines (chap. 16.4):

Display 1 shows	e.g. 000	(actual switching state of operation lines)
Display 2 shows	OPERATION LINE	(variable: switching state of operation lines)





Enter switching state using arrow keys   ↓

Display 1 shows	e.g. 40	(actually set safety controller set-point)
Display 2 shows	SP SAFETY CONTR.	(variable: safety controller set-point)

Set safety controller class 3.1 set-point in °C using arrow keys   ↓ Note setting "limit" or "offset" selected at the user level (chap. 10)! Value is shown in display 1.

Press key  ↓

If no button is pressed within more than 120 sec, or if the **EXIT** button is pressed, the controller changes to Normal Display.

- 
 When changing the set-point, check the safety controller setting in the user level (chap. 10) if the safety controller has been set to "limit" mode.
- 
 If the fan is operated with less than 100 % speed, the temperature performance and the spatial exactitude of the temperature can differ from the manufacturer's specifications. Do reduce the fan speed only if absolutely necessary due to special requirements.
- 
 The cooling power decreases when the fan speed is reduced to 20% or below.
- 
 The values entered in fixed-value entry mode remain valid after program run-off and are then equilibrated.

If the week program timer is active, depending on the running week program another set-point (SP2) may be targeted. Too high or too low temperatures can occur which exceed the permissible temperature of the charging material. Deactivate the week program timer if you do not use it (default setting, setting in the User level, chap. 10).

	<b>CAUTION</b>
	<p><b>Too high or too low temperature after the program ends.</b></p> <p><b>Damage to the charging material.</b></p> <p>➤ Deactivate the week program timer if you do not use it.</p>

## 7. Week program editor

The Week program editor permits defining up to 4 shift point for each week day. A shift point defines a moment and the switching state ON or OFF of the channels that become active in this instance.

### Channel function:

- Channel 1 On = Set-point 2 is equilibrated.
- Channel 1 Off = Set-point 1 is equilibrated
- Channel 2 = reserve

	The week program timer is initially set to inactive (factory setting). Therefore, you need to activate the week program timer in the user level (chap. 10).
-----------------------------------------------------------------------------------	-------------------------------------------------------------------------------------------------------------------------------------------------------------

### Normal Display

Display 1 shows	e.g. 19.8	(actual temperature value)
Display 2 shows	e.g. 15.05.06 13:52 - -	(actual date and time, actual state of week program timer channel 1: Off, channel 2: Off)

Press down key  ↓ for 5 sec

Display 1 shows	e.g. 0000	
Display 2 shows	PROGRAM EDITOR	(you are in the program editor)

Press down key  ↓ for 5 sec

Display 1 shows	0000	Menu visible only if week program timer is activated in the user level (chap. 10)
Display 2 shows	WEEK PROG. EDITOR	(you are in the week program editor)

Press program key  ↓

Display 1 shows	0000	
Display 2 shows	UserCod? 0000	(enter user code, display flashes)

Enter the user code using arrow keys   ↓ e.g. **0001** (basic setting, adjustable in the user level, chap. 10).  
Value is shown in both displays.

Automatically forward after 2 sec

Display 1 shows	0000	
Display 2 shows	Monday	(selection of day of the week) (actual selection: Monday)

Select the day of the week (Monday up to Sunday) with key  ↓ Day of the week is shown in display 2.

Press program key  ↓

Display 1 shows	0000	
Display 2 shows	Shiftpt.	(no function)

Press program key  ↓

Display 1 shows	0000	
Display 2 shows	Shiftpt. 1	(selection of the shift point) (actual shift point: 1)

Select the shift point (1 up to 4) with key  ↓ Value is shown in display 2.

Press program key  ↓

Display 1 shows	e.g. --:--	(time of the selected shift point)
Display 2 shows	S1: --:--	(actual selection of the shift point: S1) (actual setting: shift point not programmed)

Press program key  ↓

Display 1 shows	--:--	(time of the selected shift point)
Display 2 shows	Time --:--	(entry of the time of the selected shift point) (actual setting: shift point not programmed)

Enter the time (hh:mm) using arrow keys   ↓ Value is shown in display 2.

Press key  ↓

Display 1 shows	0000	
Display 2 shows	Ch1 = SP2: Off	(entry of the state of channel 1) (actual setting: Off)

Enter the state of channel 1 (On or Off) using arrow keys   ↓ Setting is shown in display 2.

Press key  ↓

Display 1 shows	0000	
Display 2 shows	Channel 2: Off	(entry of the state of channel 2) (no function) (actual setting: Off)

Enter the state of channel 2 (On or Off) using arrow keys   ↓ Setting is shown in display 2.

Press key  ↓

Press key **EXIT** ↓

Display 1 shows	e.g., 08.30	(time of the selected shift point)
Display 2 shows	S1: 08:30 - -	(actual selection of the shift point: S1) (actual setting: time 08.30, channels Off)

Press key **EXIT**  
Press program key  ↓

Select the next shift point

Press key **EXIT** twice ↓

Select the next day of the week

To exit the menu, press the **EXIT** key several times or wait for 120 seconds. The controller returns to normal display.

## 7.1 Program table template for Week program Editor

<b>Program editor</b>	
<b>Program title</b>	
<b>Project</b>	
<b>Date:</b>	

Day of the week	Time			Channel 1 (temperature)	Channel 2*
	hh:mm	AM	PM	ON =SP2 OFF =SP1	ON OFF
Monday	S1				
	S2				
	S3				
	S4				
Tuesday	S1				
	S2				
	S3				
	S4				
Wednesday	S1				
	S2				
	S3				
	S4				
Thursday	S1				
	S2				
	S3				
	S4				
Friday	S1				
	S2				
	S3				
	S4				
Saturday	S1				
	S2				
	S3				
	S4				
Sunday	S1				
	S2				
	S3				
	S4				

\* Channel 2 is non-functional in the standard chamber



## 8. Program editor

### 8.1 Selecting between set-point ramp and set-point step

You can program various kinds of temperature transitions. In the user level (chap. 10) you can select between the settings “Ramp” (default setting) and “Step”.

	<p>Setting “Ramp” permits programming all kinds of temperature transitions. With setting “Step” the controller will equilibrate only to constant temperatures; programming ramps is no longer possible.</p>
-----------------------------------------------------------------------------------	-------------------------------------------------------------------------------------------------------------------------------------------------------------------------------------------------------------

	<p>Switching between settings “Ramp” and “Step” will influence all programs. Please note that this can cause the time courses of existing programs to change significantly.</p>
-----------------------------------------------------------------------------------	---------------------------------------------------------------------------------------------------------------------------------------------------------------------------------

#### 8.1.1 Programming with setting “Ramp” (default setting)

Set-points always refer to the start of a program section, i.e., at the beginning of each program section, the entered set-point will be reached. During program section operation, the temperature gradually passes to the set-point entered for the subsequent program section.

You can program all kinds of temperature transitions by the appropriate design of the program section timing:

- **Gradual temperature changes “set-point ramp“**

The set-point changes its value gradually while proceeding from one program section to the next one during the programmed section length. The actual temperature value (X) follows the continually moving set-point (W) at any time.

- **Program sections with constant temperature**

The initial values of two subsequent program sections are identical; therefore the temperature is kept constant during the whole time of the first program section.

- **Sudden temperature changes “set-point step”**

Steps are temperature changes (ramps) that occur during a very short interval. Two program sections with an identical set-point are followed by a section with a different set-point. If the duration of this transitional program section is very short (minimum entry 1 min), the temperature change will proceed rapidly within the minimum amount of time.

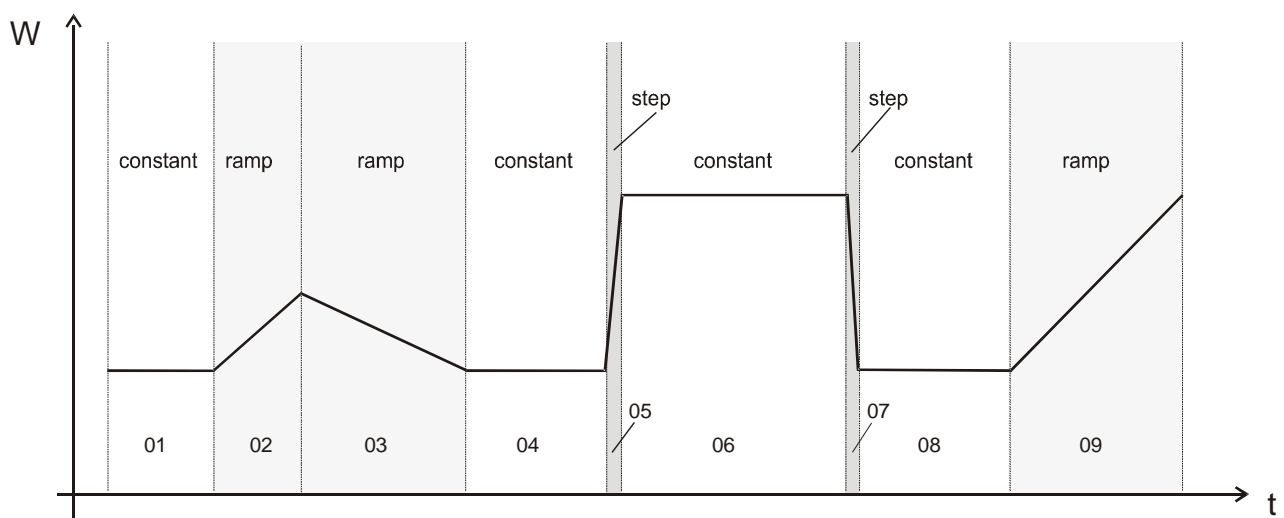
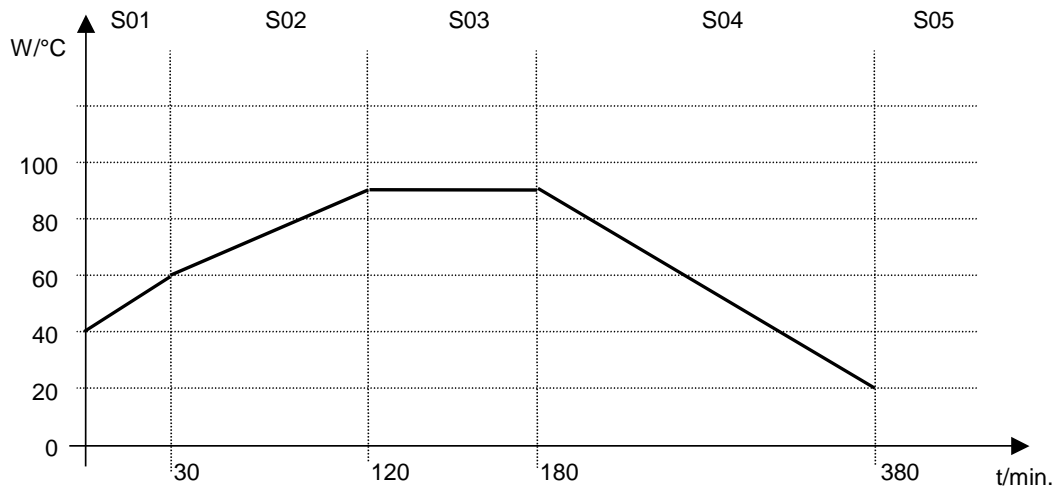

Figure 7: Possible temperature transitions  
(with default setting “ramp” in the user level (chap. 10))

**Program entry as set-point ramp (example):**



Program table corresponding to the diagram (with default setting "Ramp"):

Section	Temperature set-point [°C]	Section length [hh.mm]	Fan speed [%]	Operation lines *
SEC	TEMP	TIME	FAN	O.LINE
S01	40	00:30	50	000
S02	60	01:30	100	000
S03	90	01:00	100	000
S04	90	03:20	100	000
S05	20	00:01	100	000

\* Only with option zero-voltage relay outputs via operation lines, see chap. 16.4.

The values of such a program table can now be entered to the RD3 program controller (chap. 8.2).

**Program entry as set-point step (example):**

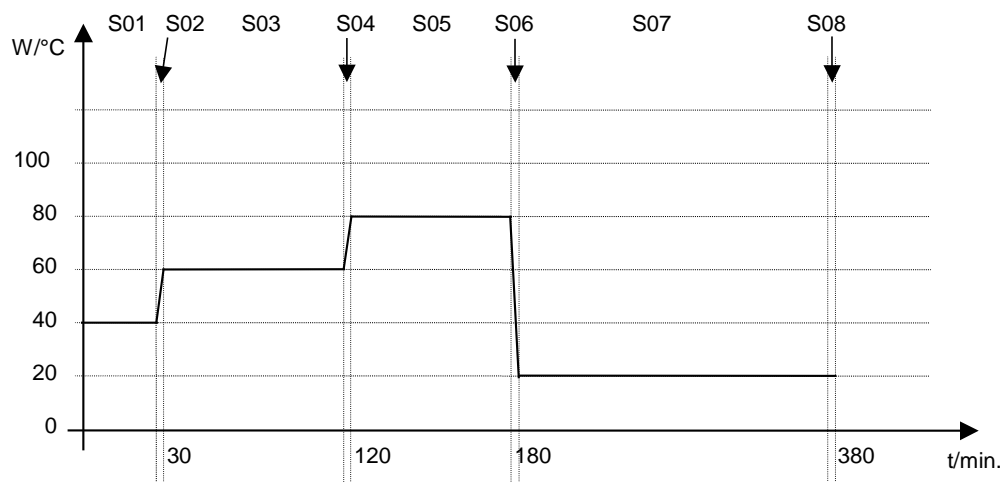

Program table corresponding to the diagram (with default setting “Ramp”):

Section	Temperature set-point [ °C]	Section length [hh.mm]	Fan speed [%]	Operation lines *
SEC	TEMP	TIME	FAN	O.LINE
S01	40	00:30	50	000
S02	40	00:01	100	000
S03	60	01:30	100	000
S04	60	00:01	100	000
S05	80	01:00	100	000
S06	80	00:01	100	000
S07	20	03:20	100	000
S08	20	00:01	100	000

\* Only with option zero-voltage relay outputs via operation lines, see chap. 16.4.

The values of such a program table can now be entered to the RD3 program controller (chap. 8.2).

The end point of the desired cycle must be programmed with an additional section (in our examples S05 for set-point ramp and S08 for set-point step) with a section time of at least one minute. Otherwise, the program will stop one section too early because the program line is incomplete.

### 8.1.2 Programming with setting “step”

With setting “Step” selected, you don’t need to program the transition section in the Program Editor.



With setting “step” the controller will equilibrate only to constant temperatures; programming ramps is no longer possible.

The set-points are maintained constant for the duration of a program section. At the start of each program section, the chamber heats up with the maximum speed in order to attain the entered set-point.

#### Program entry as set-point step (example):

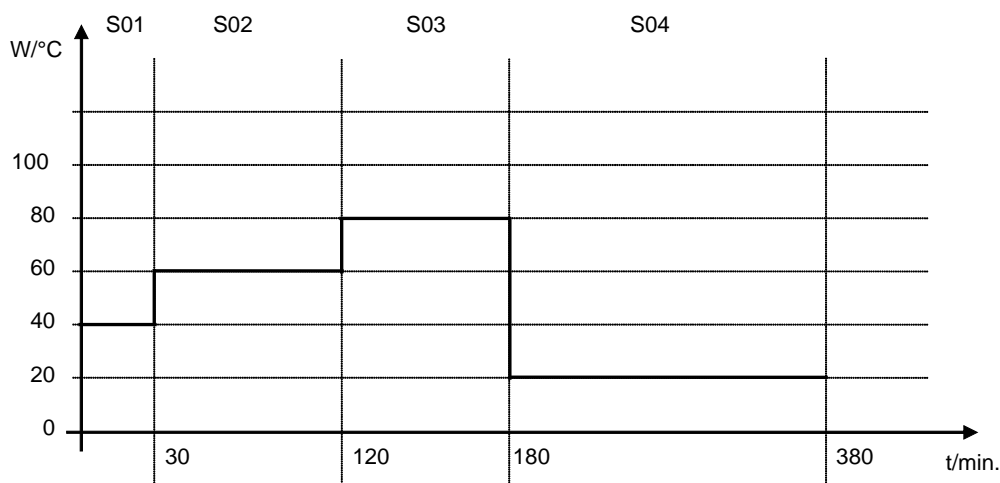

Program table corresponding to the diagram (with setting "Step"):

Section	Temperature set-point [ °C]	Section length [hh.mm]	Fan speed [%]	Operation lines *
SEC	TEMP	TIME	FAN	O.LINE
S01	40	00:30	50	000
S02	60	01:30	100	000
S03	80	01:00	100	000
S04	20	03:20	100	000

\* Only with option zero-voltage relay outputs via operation lines, see chap. 16.4.

The values of such a program table can now be entered to the RD3 program controller (chap. 8.2).

### 8.1.3 General notes on programming of temperature transitions

If the tolerance limits set in the user level (chap. 10) are exceeded, the program is halted until the actual temperature value returns to within the tolerance range. During this program interruption, the LED (3d) flashes. Therefore, the duration of the program might be extended due to the programming of tolerances

Programming is saved even in case of a power failure or after turning off the chamber.



The cooling power decreases when the fan speed is reduced to 20% or below.

After program rundown the controller returns to Fixed value operation showing Normal Display and equilibrates to the temperature value previously entered in fixed value entry mode.



Before starting the program, check the set-point value entered in Fixed value entry mode. After program rundown temperature will equilibrate to this value.



Deactivate the week program timer (factory setting, setting in the user level, chap. 10) before starting a program.

## 8.2 Set-point entry for program operation

From Normal Display the program editor is accessed by pressing button X/W for 5 sec. Then enter the set-points one after the other in all program sections of a selected program.

You can enter two programs with up to 10 sections each or one program with up to 20 sections (setting in the user level, chap. 10).

In order to avoid incorrect programming the values of the program course should be entered into a table (template in chap. 8.3).

**Example program table** (with default setting "Ramp"):

Section	Temperature set-point [ °C]	Section length [hh.mm]	Fan speed [%]	Operation lines *
SEC	TEMP	TIME	FAN	O.LINE
S01	40	00:30	50	000
S02	60	01:30	100	000
S03	90	01:00	100	000
S04	90	03:20	100	000
S05	20	00:01	100	000

\* Only with option zero-voltage relay outputs via operation lines, see chap. 16.4.

The values of the program table can now be entered to the RD3 program controller.

**Step 1 – Selecting the program and the program section:**



**Normal Display**

Press down key  ↓ for 5 sec.

Display 1 shows	e.g. 0000	
Display 2 shows	PROGRAM EDITOR	(you are in the program editor)

Press program key  ↓

Display 1 shows	0000	
Display 2 shows	UserCod? 0000	(enter user code)

Enter user code using arrow keys   ↓ e.g. **0001**  
 (basic setting, adjustable in the user level, chap. 10).  
 Value is shown in both displays.

Automatically forward after 2 sec.

Display 1 shows	e.g. 01	(program P01 selected)
Display 2 shows	--- : --- PRG.	(program can be selected)
alternating	CONTINUE X/W	(information: to 1 <sup>st</sup> program section with X/W)

Select program P01 or P02 using arrow keys   ↓ Value is shown in display 1.



Press key  ↓

In the selected program P01 or P02, program sections can be selected:

Display 1 shows	e.g. 01	(section S01 selected)
Display 2 shows	P01: --- SEC.	section S01 has already been created. enter new set-points for the individual variables with button X/W
alternating	CONTINUE X/W	

**or:**

Display 1 shows	e.g. 01	(section S01 selected)
Display 2 shows	P01: --- SEC.	section S01 has not yet been created. enter set-points for the individual variables with button X/W
alternating	NEW SEC. X/W	

Select sections S01 to S10 or to S20 using arrow keys   ↓

As long as no program section has been entered, the display switches back to 01 in case of any entry > 01, because all sections need to be entered one after the other, and each new section is created as NEWSEC.

Example: If three programs sections have been already entered, the next section to be entered is S04. Before this, no section > S04 can be selected.





**Next step – set-point entry in the desired program sections:**

**Basic entry principle:** Access the parameters of individual program sections with button X/W one after the other. Enter the values of the individual parameters with the arrow keys. A value flashes once after 2 seconds thus indicating that it has been taken over to the controller. If several parameters are to be skipped (e.g. in order to change a parameter in a posterior program section), the parameters can be rapidly jumped over by holding down the X/W key. If no button is pressed for more than 120 sec the controller toggles back to Normal Display. The program entered to this point remains stored.

Press key  ↓

Display 1 shows	e.g. 9.0 <sup>°C</sup>	(actual temperature set-point)
Display 2 shows	S01: TEMP 9.0	(variable: temperature in °C)
alternating	CONTINUE X/W	(information: go on with X/W)

Enter temperature set-point of S01 in °C using arrow keys   ↓

Press key  ↓

Display 1 shows	e.g. 00.01	(actual section length set-point)
Display 2 shows	S01: TIME 00:10	(variable: section length in hh:mm)
alternating	CONTINUE X/W	(information: go on with X/W)

Enter section length set-point of S01 in hh.mm using arrow keys   ↓ Value is shown in both displays.

Press key  ↓



Display 1 shows	e.g. 50	(actual fan speed set-point)
Display 2 shows	S01:FAN 50	(variable: fan speed in %)
alternating	CONTINUE X/W	(information: go on with X/W)

Enter fan speed set-point of S01 in % using arrow keys   ↓ Value is shown in both displays.

Press key  ↓

Only with option zero-voltage relay outputs via operation lines (chap. 16.4):

Display 1 shows	e.g. 000	(actually set switching state)
Display 2 shows	S01:O.LINE 000	(variable: switching state)
alternating	CONTINUE X/W	(Information: go on with X/W)

Enter switching state using arrow keys   ↓

Press key  ↓





### Selecting the next program sections to be entered



Display 1 shows	e.g. 02	(section S02 selected)
Display 2 shows alternating	P01: --- SEC.	Section S02 has already been created. enter new set-points for the individual parameters with X/W.
	CONTINUE X/W	

or:

Display 1 shows	e.g. 02	(section S02 selected)
Display 2 shows alternating	P01: --- SEC.	Section S02 has not yet been created. enter set-points for the individual parameters with X/W
	NEW SEC. X/W	



Select the next section to be entered using arrow keys   ↓

Display 1 shows	e.g. 12.5 <sup>°C</sup>	(actual temperature set-point)
Display 2 shows alternating	S02:TEMP 12.5	(variable: temperature in °C)
	CONTINUE X/W	(information: go on with X/W)

Enter the temperature set-point of S02 in °C using arrow keys   ↓

Etc.

If all sections up to S10 or up to S20 have been programmed, section S01 follows again. In order to quit the entry mode, press the **EXIT** button several times or wait 120 sec → the controller will then return to Normal Display.

- |                                                                                     |                                                                                                                                                                                                                                                                                 |
|-------------------------------------------------------------------------------------|---------------------------------------------------------------------------------------------------------------------------------------------------------------------------------------------------------------------------------------------------------------------------------|
|  | When changing the set-point, check the setting of the safety controller in the user level (chap. 10) if the safety controller has been set to "limit" mode.                                                                                                                     |
|  | If the fan is operated with less than 100 % speed, the temperature performance and the spatial exactitude of the temperature can differ from the manufacturer's specifications. The fan speed rate should only be reduced if absolutely necessary to meet special requirements. |
|  | The cooling power decreases when the fan speed is reduced to 20% or below.                                                                                                                                                                                                      |

### 8.3 Program table template for Program Editor

<b>Program editor</b>	
<b>Program title</b>	
<b>Project</b>	
<b>Program No.</b>	
<b>Date:</b>	

Section	Temperature set-point [ °C]	Section length [hh.mm]	Fan speed [%]	Operation lines *
<b>SEC</b>	<b>TEMP</b>	<b>TIME</b>	<b>FAN</b>	<b>O.LINE</b>
S01				
S02				
S03				
S04				
S05				
S06				
S07				
S08				
S09				
S10				
S11				
S12				
S13				
S14				
S15				
S16				
S17				
S18				
S19				
S20				

\* Only with option zero-voltage relay outputs via operation lines, see chap. 16.4.



At the standard device the operation lines (O.LINE) are without any function.



## 8.4 Deleting a program section

A program section is deleted from the program by setting the section duration to Zero.



→ Normal display

Press down key  ↓ for 5 sec.

Display 1 shows	e.g. 0000	
Display 2 shows	PROGRAM EDITOR	(you are in the program editor)

Press program key  ↓

Display 1 shows	0000	
Display 2 shows	UserCod? 0000	(enter user code)

Enter the user code using arrow keys   ↓ e.g. **0001**  
 (basic setting, adjustable in the user level, chap. 10).  
 Value is shown in both displays.

Automatically forward after 2 sec

Display 1 shows	e.g. 01	(program P01 selected)
Display 2 shows	--- : --- PRG.	(program can be selected)
alternating	CONTINUE X/W	(information: to 1 <sup>st</sup> program section with X/W)

Select the desired program, e.g. P01, using arrow keys   ↓ Value is shown in display1.

Press key  ↓

In the selected program P01 or P02, program sections can be selected:

Display 1 shows	e.g. 01	(actual selection of the section: S01)
Display 2 shows	P01: --- SEC.	(program section can be selected)
alternating	CONTINUE X/W	(information: set-point entry with X/W)

Select desired section, e.g. S03, using arrow keys   ↓ (omitted if section S01 shall be deleted).



Press key  ↓

Display 1 shows	e.g. 15.0 <sup>C</sup>	(actual temperature set-point)
Display 2 shows	S03:TEMP 15.0	(variable: temperature)
alternating	CONTINUE X/W	(information: continue with X/W)

No entry ↓

Press key  ↓

Display 1 shows	e.g. 02.30	(actual section length)
Display 2 shows	S03:TIME 02:30	(variable: section length)
alternating	CONTINUE X/W	(information: continue with X/W)

Enter set-point **Zero** for section length in hh:mm of S03 using arrow keys   ↓ Value is shown in display 2 or in both displays (display depends on maximum time setting in the user level chap. 10)

Display 1 shows	e.g. 00.00	(actual section length)
Display 2 shows	S03:TIME 00:00	(variable: section length)
alternating	DELETE SEC. X/W	(information: delete section with X/W)

Press key  ↓

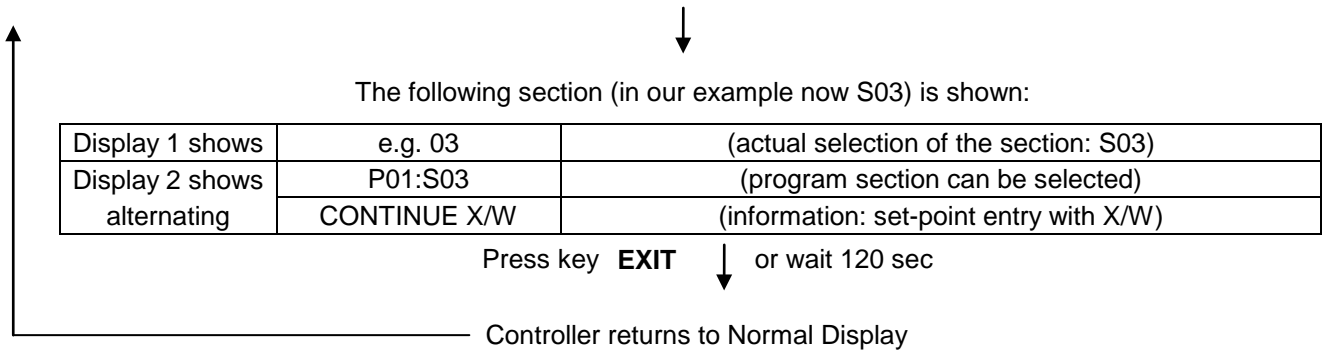

If you delete a program section which is followed by further sections, those following move up in place of the deleted section.

In our example, section S03 has been deleted. If sections S04, S05, etc. have been programmed earlier, they will now replace the preceding sections, i.e., S04 is now called S03 etc.

Deletion leads to overwriting the section by the following one. It is therefore not possible to temporarily inactivate a program section. To enter a section later to a program, all the sections following the new one must be entered again.

## 9. Program start level

Before starting the program, check the set-point entered in Fixed value operation mode. After end of the program, the temperature will equilibrate to this value.

	CAUTION
	<p><b>Too high or too low temperature after the program ends.</b>  <b>Damage to the charging material.</b></p> <p>➤ Check the set-point of Fixed value operation and if necessary adapt it.</p>

After the program ends, the temperature will equilibrate to the set-point entered in Fixed value operation mode. If the week program timer is active, another set-point (SP2) might be targeted according to programming. Deactivate the week program timer before starting the program (default setting, setting in the User level, chap. 10).

	CAUTION
	<p><b>Too high or too low temperature after the program ends.</b>  <b>Damage to the charging material.</b></p> <p>➤ Deactivate the week program timer before starting the program.</p>

In the first step a program is selected. This is on condition that a program has been entered previously (chap. 8.2) and that program type "2 programs with 10 sections each" has been selected in the user level (chap. 10).

Then the settings for the program course are defined. Two parameters can be set:

- Program delay time, i.e. a defined time before a program starts. It can be entered with a precision of 1 minute, and its maximum value is 99.59 (99 hs 59 min). If the value is 00.00, the program will start immediately. During the program delay time, all chamber functions (heating, refrigeration, and fan) are off.
- Number of program cycles, i.e. the desired number of program repeats. Values from 1 to 99 can be entered. If the program is not going to be repeated, enter the value "0". For infinite repeats enter the value "-1". The program is repeated as a whole, it is not possible to repeat individual sections.

In the last step the selected program is started. These steps must be carried out subsequently.



Deactivate the week program timer (factory setting, setting in the user level, chap. 10) before starting a program.

### Step 1 – Program selection (only with program type "2 programs" set):

#### Normal Display

Press program key  ↓

Display 1 shows	e.g. 1	(actual selection of the program)
Display 2 shows	SEL.PRG.	(select program 1 or 2)

Enter program number 1 or 2 using arrow keys   ↓ Value is shown in display 1.

#### Next step – entry of program course settings



Press program key  ↓

Display 1 shows	e.g. 00.00	(entered delay time hh.mm)
Display 2 shows	RUN TIME	(enter delay time of program start)

Set delay time in hh.mm using arrow keys   ↓ Value is shown in display 1.

Press program key  ↓

Display 1 shows	e.g. -1	(actual selection of the number of program cycles)
Display 2 shows	REPEAT	(enter number of program cycles)

Select number of cycles -1, 0, 1 etc. using arrow keys   ↓ Value is shown in display 1.

#### Last step – program start:

Press program key  ↓

Display 1 shows	e.g. 1	(selected program)
Display 2 shows	RUN PRG.	(Question: start selected program?)



Press program key  ↓

Display 1 shows	e.g. 25.5 <sup>C</sup>	actual temperature value
Display 2 shows	P01:S01 01:49:39 (time running backwards)	(actual program P01, actual section S01, and remaining time of program section S01)

Program is running. The green LED (3d) lights up.

In addition to the green LED (3d) indicating a running program, the LED (3a) is lit if the heating is active, or LED (3b) if the refrigeration is active, or none of both if the actual temperature equals the set-point.

 During program course the arrow keys and the EXIT button are not functional.

 By pressing the program key  for 3 seconds, you can terminate the program course.

If you press button  during program course, the entered set-points of the actually running program section are shown one after the other for 5 sec. each:

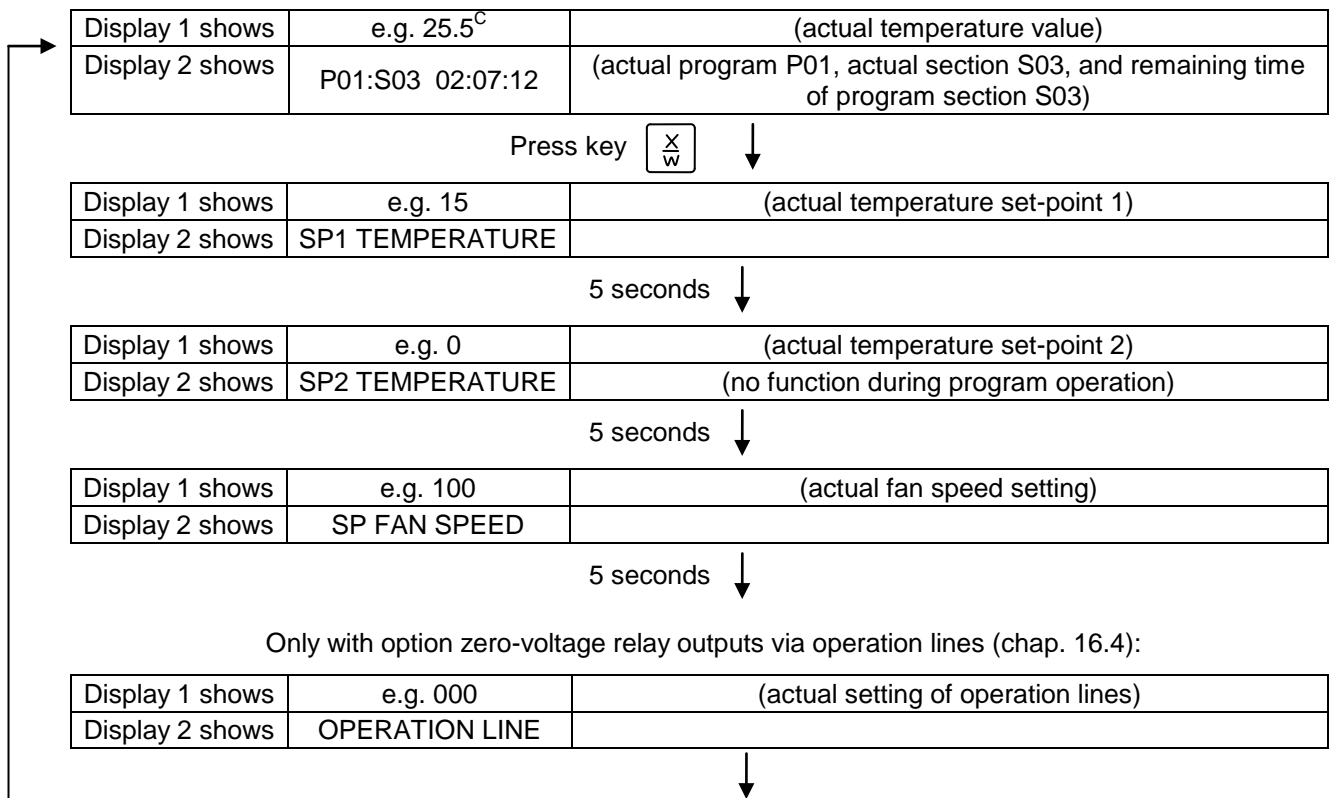

After program rundown (and, if appropriate, of the program repeats) the controller returns to fixed value operation showing Normal Display and adjusting to the temperature and fan speed values that have been previously entered in the fixed value entry mode.

## 10. User level

In this menu the following parameters can be set (in brackets the corresponding abbreviated information given in display 2):

- **Chamber address** (Address)  
Setting of controller address (1 to 254) for operation with the APT-COM™ 4 Multi Management Software.
- **User code** (User-cod)  
Modification of the user code setting (factory setting “0001”) for access to the user level and the program editor.



Keep in mind any modification of the user code. Without a valid user code it is no longer possible to access these levels.

- **Safety controller mode** (Saf.mode)  
The set-point mode can be entered as ...  
**Limit:** Maximally permitted temperature as absolute value (example: temperature set-point 37 °C / 98.6°F, limit setting to 39 °C / 102.2°F)  
**Offset:** Maximally permitted temperature exceeding of the actual set-point temperature (e.g. 2 °C). This maximally permitted temperature automatically changes with every change of the temperature set-point.
- **Safety controller set-point** (Saf.setp)  
The temperature set-point setting of the safety controller (over temperature safety device class 3.1) is shown and can be changed. An absolute value (e.g. 40 °C / 104°F) in case of setting “limit” or a relative value (e.g. 2 °C) in case of setting “Offset” can be entered.



Regularly check the setting of the set-point mode and of the over temperature safety device set-point entered in this mode for the temperature value in Fixed value operation or for the maximum temperature value of the selected temperature program in Program operation mode.

- **Decimal point position** (Decimal)  
Selection if integer values or one position after the decimal point can be entered. The integer representation is shown in Display 2 (set-point entry) while the actual value in Display 1 is always displayed with one decimal point.
- **Audio Alert** (Buzzer)  
**Inactive:** no audible signal (buzzer) in case of an alarm event.  
**Active:** in case of an alarm event (see chap. 13.2) an audible signal (buzzer) will sound. It can be reset by pressing the “EXIT” button.
- **Selection of controller menu language** (Language)  
**German, English, or French** can be selected.
- **Counter of operating hours** (Oper.hs)  
Information about the number of operating hours currently reached or since the last reset. (no setting, display only).
- **Max. number of operating hours** (Op.limit)  
Entry of a limit number of operating hours, i.e., the maximum number of operating hours that can be run. Maximum setting: 9999. Reaching the limit has no effect.
- **Reset operating hours** (Op.back)  
Reset operating hours to zero.

- **Interface protocol** (Protocol)

„**Modbus**“: The chamber interface can be used as a communication interface to connect it to a computer. This serves to control the chamber by the APT-COM™ 4 Multi Management Software. It is possible to read and write the values of all parameters.

„**Printer**“: A protocol printer for data printouts can be connected to the chamber interface. The printer regularly protocols the actual temperature value with fixed formatting and with adjustable print intervals.

In both cases an interface converter RS 422 / RS 232 is used.

- **Print interval** (Prt.-Inv.)

Setting of the print interval in minutes. Function is available only if setting “Printer” has been selected in the previous menu point.

- **Display illumination** (Disp.LED)

Selection between continuous display illumination and limited illumination that will automatically go off 300 sec after the last entry.

- **Program type selection** (PrgSelec)

Select between entry of two programs with up to 10 sections each or of one program with up to 20 sections.



When changing from 2 programs to 1 program or vice-versa, existing programs are deleted in the program editor.

- **Maximum section duration** (Prg.Time)

The maximum length of an individual program section can be set to either 99 hs 59 min or to 999 hs 59 min. This setting is then valid for all program sections.



When changing the maximum duration setting, pre-existing programs will be deleted in the program editor.

- **Set-point programming type** (Setp.sim)

Selection between “Ramp” and “Step”. With setting “Step” selected, you don’t need to program the transition section in the Program Editor.



If you select setting “step”, the controller will equilibrate only to constant temperatures; programming ramps becomes impossible.



A change between settings “ramp” and “step” will influence all programs. Note that significant change in time courses may arise in existing programs.

- **Tolerance limit range** (Tol.band)

Entry of a tolerance limit value in °C. Program operation: If the actual value of temperature exceeds the set-point of a program section by more than the entered tolerance limit value, the program is halted (LED (3d) flashing) until the actual temperature value is again within the tolerance range.

Entry of “0” means tolerance limits are off.

- **Activating or inactivating the week program timer** (Prog.Clk)

„**Inactive**“: The week program timer is switched off (factory setting). The corresponding setting menu (chap. 7) is not visible, nor is set-point 2 in the Fixed value entry mode (chap. 6).

„**Active**“: The week program timer is activated.

	When deactivating the week program timer, any programming made in advance will remain in memory and take effect when the week program timer is activated again.
-----------------------------------------------------------------------------------	-----------------------------------------------------------------------------------------------------------------------------------------------------------------

	Deactivate the week program timer before entering set-points in fixed value entry mode (chap. 6). Otherwise, any setting of the operation lines is ineffective.
-----------------------------------------------------------------------------------	-----------------------------------------------------------------------------------------------------------------------------------------------------------------

	Deactivate the week program timer before starting a program (chap. 9).
-----------------------------------------------------------------------------------	------------------------------------------------------------------------

- **Display mode (12h/24h)**

Select between 12 hours (display “AM” or “PM”) or 24 hours.

- **Date of the real time clock (Date)**

Main menu. Use the program key to access the settings of year, month, and day in the corresponding submenus.

- **Year of the real time clock (Year)**

Enter the year (2006 up to 2050)

- **Month of the real time clock (Month)**

Enter the month (1 up to 12).

- **Day of the real time clock (Day)**

Enter the day (1 up to 31).

- **Time of the real time clock (Time)**

Main menu. Use the program key to access the settings of hour and minute in the corresponding submenus.

	There is no automatic switch between daylight saving time and regular time.
-------------------------------------------------------------------------------------	-----------------------------------------------------------------------------

- **Hour of the real time clock (Hour)**

Enter the hour (0 up to 23).

- **Minute of the real time clock (Minute)**

Enter the minute (0 up to 59).

### Normal Display

Display 1 shows	e.g. 19.8	(actual temperature value)
Display 2 shows	e.g. 15.05.06 13:52 - -	(actual date and time, actual switching state of week program timer channel 1: Off, channel 2: Off)

Press down key  ↓ for 5 sec

Display 1 shows	e.g. 0000	
Display 2 shows	PROGRAM EDITOR	(you are in the program editor)

Press down key  ↓ for 5 sec



Display 1 shows	0000	Menu visible only if week program timer is activated.
Display 2 shows	WEEK PROG. EDITOR	(you are in the week program editor)

Press down key  ↓ for 5 sec

Display 1 shows	0000	
Display 2 shows	USER – LEVEL	(you are in the user level)

Press program key  ↓

Display 1 shows	0000	
Display 2 shows	UserCod? 0000	(enter user code, display flashes)

Enter the user code using arrow keys   ↓ e.g. **0001** (basic setting, or the valid code in case it has been previously changed in this menu). Value is shown in both displays.

Automatically forward after 2 sec



Display 1 shows	1	(actual address: 1)
Display 2 shows	Adress 1	(entry of chamber address) (actual address: 1)

Enter the chamber address (1 up to 254) using arrow keys   ↓ Address is shown in both displays.

Press key  ↓

Display 1 shows	1	(actually valid user code: 1)
Display 2 shows	User-cod 1	(change user code) (actually set: 1)

Enter a new value using arrow keys   ↓ Value is shown in both displays.

Press key  ↓

Display 1 shows	0000	(no function)
Display 2 shows	Saf.mode: Limit	(select set-point mode of safety controller) (actual setting: "limit")

Select between "Limit" and "Offset" using arrow keys   ↓ Setting is shown in display 2.

Press key  ↓

Display 1 shows	e.g. 65	(actual setting: 65 °C / 149°F)
Display 2 shows	Saf.setp 65	(temperature value of over temperature safety device) (actual value: 65 °C / 149°F)

Enter a new value using arrow keys   ↓ Value is shown in both displays.



Press key  ↓

Display 1 shows	0000	(no function)
Display 2 shows	Decimal: XXX.X	(setting of decimal point position) (actual setting: XXX.X)

Select decimal point position using arrow keys   ↓ Decimal point position XXX.X or XXXX. is shown in display 2.

Press key  ↓

Display 1 shows	0000	(no function)
Display 2 shows	Buzzer : Active	(setting of the alarm buzzer) (actual setting: „Active“)

Select between “Active” and “Inactiv” using arrow keys   ↓ Setting is shown in display 2.

Press key  ↓

Display 1 shows	0000	(no function)
Display 2 shows	Language : English	(selection of controller language) (actual setting: English)

Select between languages German, English, and French using arrow keys   ↓ Setting is shown in display 2.

Press key  ↓

Display 1 shows	e.g. 0004	(chamber operating hours)
Display 2 shows	Oper.hs 0004:28	(operating hours up to now hhhh:mm) (actually displayed: 4 hs 28 min)

Press key  ↓

Display 1 shows	e.g. 9999	(actual setting: 9999 hs)
Display 2 shows	Op.limit 9999:00	(maximum number of operating hours hhhh:mm (actual setting: 9999 hs)

Set value using arrow keys   ↓ Setting is shown in both displays.

Press key  ↓

Display 1 shows	0000	(no function)
Display 2 shows	Op.back : No	(reset counter of operating hours ?) (actual setting: No)

Select between “Yes” and “No” using arrow keys   ↓ Setting is shown in display 2.

Press key  ↓

Display 1 shows	0000	(no function)
Display 2 shows	Protocol: MODBUS	(Selection of interface mode) (actual setting: Modbus)

Select between protocols “MODBUS” and “Printer” using arrow keys   ↓ Setting is shown in display 2.

Press key  ↓



Display 1 shows	e.g. 3	(actual setting: 3 minutes)
Display 2 shows	Prt-Inv. 3	(print interval) (actual setting: 3 min)

Select value between 0 and 255 minutes using arrow keys   ↓ Setting is shown in displays 1 and 2.

Press key  ↓

Display 1 shows	0000	
Display 2 shows	Disp.LED: No	(continuous display illumination?) (actual setting: No)

Select between "Yes" and "No" using arrow keys   ↓ Setting is shown in display 2.



Press key  ↓

Display 1 shows	0000	
Display 2 shows	PrgSelec: 2Prg10S	(1 program with max. 20 sections or 2 programs with max. 10 sections each?) (actual setting: 2Prg10S)

Select between "2Prg10S" and "1Prg20S" using arrow keys   ↓ Setting is shown in display 2.



Press key  ↓

Display 1 shows	0000	
Display 2 shows	Prg.Time: 99:59	(max. section length 99:59 or 999:59?) (actual setting: 99:59)

Select between 99:59 in hh:mm or 999:59 in hhh:mm using arrow keys   ↓ Setting is shown in display 2.

Press key  ↓

Display 1 shows	0000	
Display 2 shows	Setp.sim Ramp	(ramp or step?) (actual setting: ramp)

Select between Ramp and Step using arrow keys   ↓ Setting is shown in display 2.



Press key  ↓

Display 1 shows	0000	
Display 2 shows	Tol.band 0	(Tolerance limits in °C) (actual setting: 0)

Set value in °C using arrow keys   ↓ Setting is shown in display 2.

Press key  ↓

Display 1 shows	0000	
Display 2 shows	Prog.Clk Inactive	(Week program timer active or inactive?) (actual setting: Inactive)

Select between "Active" and "Inactive" using arrow keys   ↓ Setting is shown in display 2.

Press key  ↓

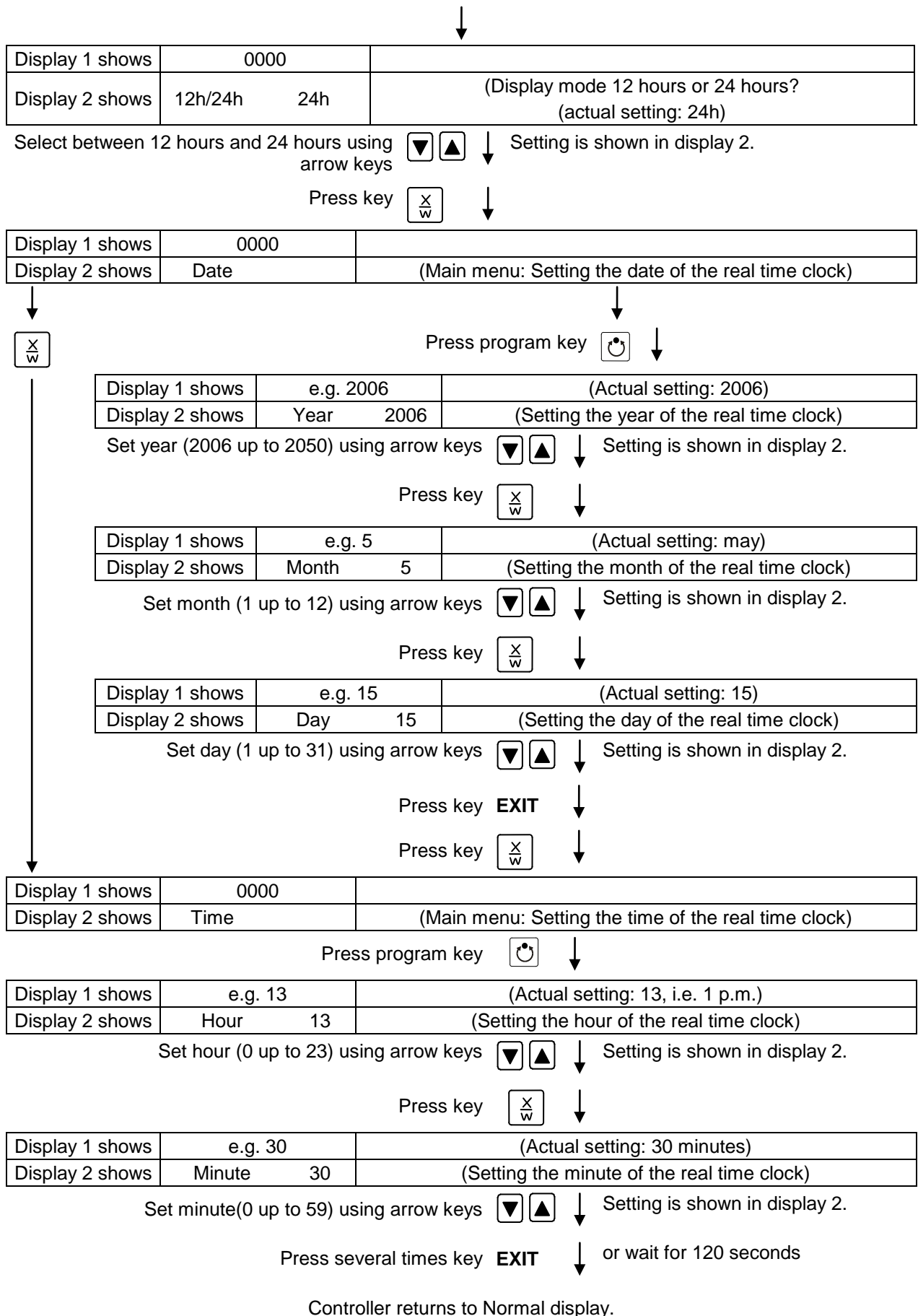

## 11. Programming example of the Week Program Editor

### 11.1 Desired time function

From Monday to Friday the chamber shall maintain a temperature of +20 °C / 68°F, and during the weekend (Saturday and Sunday) a temperature of +5 °C / 41°F.

This program shall automatically run during the whole year, i.e. it shall be programmed just once.

### 11.2 Proceeding overview

#### 1. Settings in the user level (see chap. 10)

- **Setting the safety controller to “Limit” and 3 °C above the maximum temperature value of the program**

The temperature set-point of the safety controller (over temperature protection class 3.1) is displayed and can be changed. You can enter an absolute value in case of setting “limit”, or a relative value in case of setting “Offset”. Select setting “Limit” and enter a value by 3 °C above the maximum value (i.e., 23 °C / 73.4°F).

- **Activating the week program timer**
- **Checking and, if necessary, setting the real time clock**

#### 2. Entering the set-points for the week program in “Fixed value entry mode” (see chap. 6)

Set-points for the example program:

SP 1 (night / weekend) = 5 °C / 41 °F

SP 2 (day / week) = 20 °C / 68 °F

#### 3. Entering the time program to the week program editor (see chap. 7)

Program table for the example program:

Day of the week	Time			Channel 1 (temperature)	
	hh:mm	AM	PM	ON (SP2)	OFF (SP1)
Monday	S1 06:00			ON	
Friday	S1 20:00			OFF	



Make sure that no other shift points have been preprogrammed. If so, they must be deleted:  
Set the time of the respective shift point to “--:--” using key .

## 11.3 Proceeding in detail

### 1. Settings in the user level:

- Setting the safety controller to “Limit” and 3 °C above the maximum temperature value of the program
- Activating the week program timer
- Checking and, if necessary, setting the real time clock

#### Normal Display

Display 1 shows	e.g. 19.8	(actual temperature value)
Display 2 shows	e.g. 15.05.06 13:52 - -	(actual date and time, actual switching state of week program timer channel 1: Off, channel 2: Off)

Press down key  ↓ for 5 sec

Display 1 shows	e.g. 0000	
Display 2 shows	PROGRAM EDITOR	(you are in the program editor)

Press down key  ↓ for 5 sec

Display 1 shows	0000	Menu visible only if week program timer is activated.
Display 2 shows	WEEK PROG. EDITOR	(you are in the week program editor)

Press down key  ↓ for 5 sec

Display 1 shows	0000	
Display 2 shows	USER – LEVEL	(you are in the user level)

Press program key  ↓

Display 1 shows	0000	
Display 2 shows	UserCod? 0000	(enter user code, display flashes)

Enter the user code using arrow keys   ↓ e.g. **0001** (basic setting, or the valid code in case it has been previously changed in this menu). Value is shown in both displays.

Automatically forward after 2 sec

Display 1 shows	1	(actual address)
Display 2 shows	Address 1	(entry of chamber address) (actual address: 1)

Press several times key  ↓ until **Saf.mode** appears:

Display 1 shows	0000	(no function)
Display 2 shows	Saf.mode: Limit.	(select set-point mode of safety controller) (actual setting: „limit“)

Select “Limit” using arrow keys   ↓ Setting is shown in display 2.

Press key  ↓

Display 1 shows	23	(actually set temperature value)
Display 2 shows	Saf.setp 23	(temperature value of over temperature safety device) (actual value: 23 °C / 73.4°F)

Enter the temperature value of **23** in °C using arrow keys   ↓ Value is shown in both displays.

Press several times key  ↓ until **Prog.Clk** appears:

Display 1 shows	0000	
Display 2 shows	Prog.Clk Active	(Week program timer active or inactive? (actual setting: Active))

Select "**Active**" using arrow keys   ↓ Setting is shown in display 2.

Press key  ↓

Display 1 shows	0000	
Display 2 shows	12h/24h 24h	(Display mode 12 hours or 24 hours? (actual setting: 24h))

Press key  ↓

Display 1 shows	0000	
Display 2 shows	Date	(Main menu: Setting the date of the real time clock)

Press program key  ↓

Display 1 shows	e.g. 2006	(Actual setting: 2006)
Display 2 shows	Year 2006	(Setting the year of the real time clock)

Set **year** (2006 up to 2050) using arrow keys   ↓ Setting is shown in display 2.

Press key  ↓

Display 1 shows	e.g. 5	(Actual setting: may)
Display 2 shows	Month 5	(Setting the month of the real time clock)

Set **month** (1 up to 12) using arrow keys   ↓ Setting is shown in display 2.

Press key  ↓

Display 1 shows	e.g. 15	(Actual setting: 15)
Display 2 shows	Day 15	(Setting the day of the real time clock)

Set **day** (1 up to 31) using arrow keys   ↓ Setting is shown in display 2.

Press key **EXIT** ↓

Press key  ↓

Display 1 shows	0000	
Display 2 shows	Time	(Main menu: Setting the time of the real time clock)

Press program key  ↓

Display 1 shows	e.g. 13	(Actual setting: 13, i.e. 1 p.m.)
Display 2 shows	Hour 13	(Setting the hour of the real time clock)

Set **hour** (0 up to 23) using arrow keys   ↓ Setting is shown in display 2.

Press key  ↓

Display 1 shows	e.g. 30	(Actual setting: 30 minutes)
Display 2 shows	Minute 30	(Setting the minute of the real time clock)

Set **minute** (0 up to 59) using arrow keys   ↓ Setting is shown in display 2.

Press several times key **EXIT** ↓ or wait for 120 seconds

Controller returns to normal display.

## 2. Entering the set-points for the week program in Fixed value entry mode (see chap. 6)

Set-points for the example program:

SP 1 (night / weekend) = 5 °C / 41 °F



SP 2 (day / week) = 20 °C / 68 °F

### Normal Display

Display 1 shows	e.g. 19.8	(actual temperature value)
Display 2 shows	e.g. 15.05.06 13:52 - -	(actual date and time, actual switching state of week program timer channel 1: Off, channel 2: Off)

Press key  ↓

Display 1 shows	5.0	(actual temperature set-point 1)
Display 2 shows	SP1 TEMPERATURE	(variable: temperature in °C)

Enter temperature set-point **5 °C** using arrow keys   ↓ Value is shown in display 1.

Press key  ↓

Display 1 shows	20.0	(actual temperature set-point 2)
Display 2 shows	SP2 TEMPERATURE	(variable: temperature in °C)

Enter temperature set-point **20 °C** using arrow keys   ↓ Value is shown in display 1.



Press the EXIT button. The controller changes to Normal Display.

## 3. Entering the time program to the week program editor

Program table for the example program:

Day of the week	Time			Channel 1 (temperature)	
	hh:mm	AM	PM	ON (SP2)	OFF (SP1)
Monday	S1 06:00			ON	
Friday	S1 20:00			OFF	

SP 1 (night / weekend) = 5 °C, SP 2 (day / week) 20 °C

	Make sure that no other shift points have been preprogrammed. If so, they must be deleted: Set the time of the respective shift point to “--:--” using key  .
-------------------------------------------------------------------------------------	-------------------------------------------------------------------------------------------------------------------------------------------------------------------------------------------------------------------------------------------------------

### Normal Display

Display 1 shows	e.g. 19.8	(actual temperature value)
Display 2 shows	e.g. 15.05.06 13:52 - -	(actual date and time, actual state of week program timer channel 1: Off, channel 2: Off)

Press down key  ↓ for 5 sec

Display 1 shows	e.g. 0000	
Display 2 shows	PROGRAM EDITOR	(you are in the program editor)

Press down key  ↓ for 5 sec

Display 1 shows	0000	
Display 2 shows	WEEK PROG. EDITOR	(you are in the week program editor)

Press program key  ↓

Display 1 shows	0000	
Display 2 shows	UserCod? 0000	(enter user code, display flashes)

Enter the user code using arrow keys   ↓ e.g. **0001** (basic setting, adjustable in the user level, chap. 10).  
Value is shown in both displays.

Automatically forward after 2 sec

Display 1 shows	0000	
Display 2 shows	Monday	(selection of day of the week) (actual selection: Monday)

Select the first day of the week (**Monday**) with key  ↓ Day of the week is shown in display 2.

Press program key  ↓

Display 1 shows	0000	
Display 2 shows	Shiftpt.	(no function)

Press program key  ↓

Display 1 shows	0000	
Display 2 shows	Shiftpt. 1	(selection of the shift point) (actual shift point: 1)

Select shift point 1 with key  ↓ Value is shown in display 2.

Press program key  ↓

Display 1 shows	e.g. --:--	(time of the selected shift point)
Display 2 shows	S1: --:--	(actual selection of the shift point: S1) (actual setting: shift point not programmed)

Press program key  ↓

Display 1 shows	06.00	(time of the selected shift point)
Display 2 shows	Time 06:00	(entry of time of the selected shift point) (actual setting: 6.00, i.e. 6 a.m.)

Enter the time **06:00** using arrow keys   ↓ Value is shown in display 2.



Press key  ↓

Display 1 shows	0000	
Display 2 shows	Ch1 = SP2: On	(entry of state of channel 1) (actual setting: On)

Enter the state of channel 1   ↓ Setting is shown in display 2.  
**On** using arrow keys

Press key  ↓

Display 1 shows	0000	
Display 2 shows	Channel 2: Off	(entry of state of channel 2) (actual setting: Off)

Press key **EXIT** ↓

Display 1 shows	06.00	(time of the selected shift point)
Display 2 shows	S1: 06:00 □ -	(actual selection of the shift point: S1) (actual setting: time 06.00, channel 1 ON)

Press key **EXIT** twice ↓ to select the next day of the week

Display 1 shows	0000	
Display 2 shows	Friday	(selection of day of the week) (actual selection: Friday)

Select the next day of the week (**Friday**) with key  ↓ Day of the week is shown in display 2.

Press program key  ↓

Display 1 shows	0000	
Display 2 shows	Shiftpt.	(no function)

Press program key  ↓

Display 1 shows	0000	
Display 2 shows	Shiftpt. 1	(selection of the shift point) (actual shift point: 1)

Select shift point 1 with key  ↓ Value is shown in display 2.

Press program key  ↓

Display 1 shows	e.g. --:--	(time of the selected shift point)
Display 2 shows	S1: --:--	(actual selection of the shift point: S1) (actual setting: shift point not programmed)

Press program key  ↓

Display 1 shows	20.00	(time of the selected shift point)
Display 2 shows	Time 20:00	(entry of time of the selected shift point) (actual setting: 20.00, i.e. 8 p.m.)

Enter the time **20:00** using arrow keys   ↓ Value is shown in display 2.

Press key  ↓

Display 1 shows	0000	
Display 2 shows	Ch1 = SP2: Off	(entry of state of channel 1) (actual setting: OFF)

Enter the state of channel 1   ↓ Setting is shown in display 2.  
**Off** using arrow keys

Press key  ↓

Display 1 shows	0000	
Display 2 shows	Channel 2: Off	(entry of state of channel 2) (actual setting: Off)

Press key **EXIT** ↓

Display 1 shows	20.00	(time of the selected shift point)
Display 2 shows	S1: 20:00 - -	(actual selection of the shift point: S1) (actual setting: time 20.00, channels OFF)

Press several times key **EXIT** ↓ or wait for 120 seconds

Controller returns to normal display.

## 12. Programming example of the Program Editor

### 12.1 Desired time function

From Monday to Friday the chamber shall maintain a temperature of +20 °C / 68°F, and during the week-end (Saturday and Sunday) a temperature of +5 °C / 41°F.

This program shall automatically run during the whole year, i.e. it shall be programmed just once.

### 12.2 Proceeding overview

#### 1. Settings in the user level (see chap. 10)

- **Setting the safety controller to “Limit” and 3 °C above the maximum temperature value of the program**

The temperature set-point of the safety controller (over temperature protection class 3.1) is displayed and can be changed. You can enter an absolute value in case of setting “limit”, or a relative value in case of setting “Offset”. Select setting “Limit” and enter a value by 3 °C above the maximum value (i.e., 23 °C / 73.4°F).

- **Setting the maximum section duration (Prg. Time) to 999 hs. 59 min.**

The maximum length of a program section can be set – in common for all program sections – to 99 hs 59 min or to 999 hs 59 min. Select setting 999:59.



When changing the maximum duration setting, pre-existing programs will be deleted in the program editor.

- **Switching off the tolerance limits function**

Select setting “0” meaning tolerance limits off. Thus an interruption of the program course during the heating-up or cooling-down phases during the rapid “set-point step” phase is avoided.

- **Deactivating the week program timer**

Deactivate the week program timer before entering a program (factory setting). Otherwise, any setting of the operation lines in the program editor is ineffective.

#### 2. Entering the time program to the program editor

Program table for the example program:

Section	Temperature set-point [ °C]	Section length [hh.mm]	Fan speed [%]	operation lines
SEC	TEMP	TIME	FAN	O.LINE
S01	20	119:59	100	000
S02	20	000:01	100	000
S03	5	047:59	100	000
S04	5	000:01	100	000



Make sure that there are no more program sections (S05 etc.) existing due to previous programming. If so, they must be deleted (see chap. 8.4)

### 3. Set the number of cycles to infinite in the program start level and start the program



The described example program must be started once at the precise moment of temperature change (on Monday e.g., at 0.01 or at 7.00). If the program cannot be manually started at the desired moment, you can program a suitable program delay-time of 99 hs. 59 min. max. After rundown of this delay time, the program will start automatically (chap. 9).

## 12.3 Proceeding in detail

### 1. Settings in the user level:

- **Setting the safety controller to “Limit” and 3 °C above the maximum temperature value of the program**

The temperature set-point of the safety controller (over temperature protection class 3.1) is shown and can be changed. An absolute value in case of setting “limit”, or a relative value in case of setting “Offset” can be entered. Select setting “Limit” and enter a value, which is by 3 °C above the maximum value (i.e., 23 °C / 73.4°F).

- **Setting the maximum section duration (Prg. Time) to 999 hs. 59 min.**

The maximum length of a program section can be set – in common for all program sections – to 99 hs 59 min or to 999 hs 59 min. Select setting 999:59.



When changing the maximum duration setting, pre-existing programs will be deleted in the program editor.

- **Switching off the tolerance limits function**

Select setting “0” meaning tolerance limits off. Thus an interruption of the program course during the heating-up or cooling-down phases during the rapid “set-point step” phase is avoided.

- **Deactivating the week program timer**

Deactivate the week program timer before entering a program (factory setting). Otherwise, any setting of the operation lines in the program editor is ineffective.

#### Normal Display

Display 1 shows	e.g. 19.8	(actual temperature value)
Display 2 shows	e.g. 15.05.06 13:52 - -	(actual date and time, actual switching state of week program timer channel 1: Off, channel 2: Off)

Press down key  ↓ for 5 sec

Display 1 shows	e.g. 0000	
Display 2 shows	PROGRAM EDITOR	(you are in the program editor)

Press down key  ↓ for 5 sec

Display 1 shows	0000	Menu visible only if week program timer is activated
Display 2 shows	WEEK PROG. EDITOR	(you are in the week program editor)



Press down key  ↓ for 5 sec

Display 1 shows	0000	
Display 2 shows	USER-LEVEL	(you are in the user level)

Press program key  ↓



Display 1 shows	0000	
Display 2 shows	UserCod? 0000	(enter user code, display flashes)

Enter the user code using arrow keys   ↓ e.g. **0001** (basic setting, or the valid code in case it has been previously changed in this menu). Value is shown in both displays.

Automatically forward after 2 sec

Display 1 shows	1	(actual address)
Display 2 shows	Adress 1	(entry of chamber address) (actual address: 1)

Press several times key  ↓ until **Saf.mode** appears

Display 1 shows	0000	(no function)
Display 2 shows	Saf.mode: Limit.	(select set-point mode of safety controller) (actual setting: „limit“)

Select "**Limit**" using arrow keys   ↓ Setting is shown in display 2.

Press key  ↓

Display 1 shows	23	(actually set temperature value)
Display 2 shows	Saf.setp 23	(temperature value of over temperature safety device) (actual value: 23 °C / 73.4°F)

Enter the temperature value of **23** in °C using arrow keys   ↓ Value is shown in both displays.

Press several times key  ↓ until **Prg.Time** appears

Display 1 shows	0000	
Display 2 shows	Prg.Time: 999:59	(max. section length 99:59 or 999:59?) (actual setting: 999:59)

Select **999:59** in hhh:mm using arrow keys   ↓ Setting is shown in display 2.



Press key  ↓

Display 1 shows	0000	
Display 2 shows	Tol.Band 0	(Tolerance limits in °C) (actual setting: 0)

Set value **0** meaning tolerance limits off using arrow keys   ↓ Setting is shown in display 2.

Press key  ↓

Display 1 shows	0000	
Display 2 shows	Prog.Clk Inactive	(Week program timer active or inactive?) (actual setting: Inactive)

Select "**Inactive**" meaning week program timer off, using arrow keys   ↓ Setting is shown in display 2.

Press several times key **EXIT** ↓ or wait 120 sec.

Controller returns to Normal Display.

## 2. Entering the time program to the program editor

Program table for the example program:

Section	Temperature set-point [ °C]	Section length [hh.mm]	Fan speed [%]	Operation lines
SEC	TEMP	TIME	FAN	O.LINE
S01	20	119:59	100	000
S02	20	000:01	100	000
S03	5	047:59	100	000
S04	5	000:01	100	000

In this example the program will be entered to the first program place (P01).



### Normal display

Press key  ↓ for 5 sec.

Display 1 shows	e.g. 0000	
Display 2 shows	PROGRAM EDITOR	(you are in the program editor)

Press program key  ↓

Display 1 shows	0000	
Display 2 shows	UserCod? 0000	(enter user code)

Enter user code using arrow keys   ↓ e.g. **0001**  
(basic setting, adjustable in the user level, chap. 10).  
Value is shown in both displays.

Automatically forward after 2 sec.



Display 1 shows	01	program P01 selected
Display 2 shows	---:--- PRG.	program can be selected
alternating	CONTINUE X/W	(information: to 1 <sup>st</sup> program section with X/W)

Select program **P01** using arrow keys   ↓ Value is shown in Display 1.

Press key  ↓



In the selected program P01 the first program section S01 is shown:

Display 1 shows	01	section S01 has been selected
Display 2 shows	P01: --- SEC.	enter new set-points for the individual variables with button X/W.
alternating	CONTINUE X/W or NEW SEC. X/W	

Select section S01 using arrow keys   ↓

Press key  ↓

Display 1 shows	20.0 <sup>°C</sup>	(actual temperature set-point)
Display 2 shows	S01: TEMP 20.0	(variable: temperature in °C)
alternating	CONTINUE X/W	(information: go on with X/W)

Entry of temperature set-point of **20 °C** using arrow keys   ↓



Press key  ↓

Display 1 shows	119	(actual section length set-point)
Display 2 shows alternating	S01: TIME 119:59	(variable: section length in hhh:mm)
	CONTINUE X/W	(information: go on with X/W)

Enter section length set-point of S01 of **119**   ↓ Value is shown in both displays.  
**hs. 59 min.** using arrow keys



Press several times key  ↓ until **P01: --- SEC** appears:

Display 1 shows	02	section S02 has been selected
Display 2 shows alternating	P01: --- SEC.	enter new set-points for the individual variables with button X/W.
	CONTINUE X/W	
	or NEW SEC. X/W	

Select section S02 using arrow keys   ↓

Press key  ↓

Display 1 shows	20.0 <sup>°C</sup>	(actual temperature set-point)
Display 2 shows alternating	S02: TEMP 20.0	(variable: temperature in °C)
	CONTINUE X/W	(information: go on with X/W)

Entry of temperature set-point of **20** in °C of S02 using arrow keys   ↓



Press key  ↓

Display 1 shows	000	(actual section length set-point)
Display 2 shows alternating	S02: TIME 000:01	(variable: section length in hhh:mm)
	CONTINUE X/W	(information: go on with X/W)

Enter section length set-point of S02 of **1**   ↓ Value is shown in both displays.  
**min** using arrow keys



Press several times key  ↓ until **P01: --- SEC** appears:

Display 1 shows	03	section S03 has been selected
Display 2 shows alternating	P01: --- SEC.	enter new set-points for the individual variables with button X/W.
	CONTINUE X/W	
	or NEW SEC. X/W	

Select section S03 using arrow keys   ↓

Press key  ↓

Display 1 shows	5 <sup>°C</sup>	(actual temperature set-point)
Display 2 shows alternating	S02:TEMP 5	(variable: temperature in °C)
	CONTINUE X/W	(information: go on with X/W)

Entry of temperature set-point of **5 °C** of S03 using arrow keys   ↓



Press key  ↓

Display 1 shows	047	(actual section length set-point)
Display 2 shows alternating	S02: TIME 047:59	(variable: section length in hhh:mm)
	CONTINUE X/W	(information: go on with X/W)

Enter section length set-point of S03 of **47 hs. 59 min.** using arrow keys   ↓ Value is shown in both displays.



Press several times key  ↓ until **P01: --- SEC** appears:

Display 1 shows	04	section S04 has been selected
Display 2 shows alternating	P01: --- SEC.	enter new set-points for the individual variables with button X/W.
	CONTINUE X/W	
	or NEW SEC. X/W	

Select section S04 using arrow keys   ↓

Press key  ↓

Display 1 shows	5 <sup>°C</sup>	(actual temperature set-point)
Display 2 shows alternating	S02:TEMP 5	(variable: temperature in °C)
	CONTINUE X/W	(information: go on with X/W)

Entry of temperature set-point of **5 °C** of S04 using arrow keys   ↓

Press key  ↓

Display 1 shows	000	(actual section length set-point)
Display 2 shows alternating	S02: TIME 000:01	(variable: section length in hhh:mm)
	CONTINUE X/W	(information: go on with X/W)

Enter section length set-point of S04 of **1 min.** using arrow keys   ↓ Value is shown in both displays.

Press key **EXIT** ↓ several times or wait 120 sec.

Controller returns to Normal Display



Make sure that there are no more program sections (S05 etc.) existing due to previous programming. If so, they must be deleted (see chap. 8.4)



### 3. Setting the number of cycles to infinite in the program start level and starting the program

 The described example program must be started once at the precise moment of temperature change (on Monday e.g., at 0.01 or at 7.00). If the program cannot be manually started at the desired moment, you can program a suitable program delay-time (max. 99 hs. 59 min.). After rundown of this delay time the program starts automatically (see chap. 9).

#### Normal Display



Press program key  ↓

Display 1 shows	1	actual selection of the program
Display 2 shows	SEL.PRG.	select program 1 or 2

Enter program number 1 using arrow keys   ↓ Value is shown in display 1.

Press program key  ↓

Display 1 shows	e.g. 00.00	(entered delay time hh.mm)
Display 2 shows	RUN TIME	(enter delay time of program start)

Set delay time, if desired, in hh.mm using   ↓ Setting 00.00 means no delay time (immediate program start)  
Value is shown in display 1.

Press program key  ↓

Display 1 shows	-1	actual selection of the number of program cycles: infinite
Display 2 shows	REPEAT	(enter number of program cycles)

Select number of cycles “-1”, i.e. infinite repeats, using arrow keys   ↓ Value is shown in display 1.

Press program key  ↓

Display 1 shows	1	selected program
Display 2 shows	RUN PRG.	Question: start selected program?



Press program key  ↓

Display 1 shows	20.0 <sup>C</sup>	actual temperature value
Display 2 shows	P01:S01 119:49 (time running backwards)	actual program P01, actual section S01, and remaining time of program section S01

Program is running. The green LED (3d) lights up.

Additionally to the green LED (3d) indicating a running program LED (3a) is lit if the heating is active, or LED (3b) if the refrigeration is active, or none of both if the actual temperature equals the set-point.

During program course the arrow keys and the EXIT button are not functional.

 By pressing the program key  for 3 seconds, you can terminate the program course.

If you press button  during program course, the entered set-points of the actually running program section are shown one after the other for 5 sec. each:

## 13. Performance in case of failures

### 13.1 Performance after a power failure

#### Power failure during fixed-value operation (Normal Display):

The entered parameters remain saved. After power returns, operation continues with the set parameters.

#### Power failure during program operation:

After power returns, program course continues with the set-points that have been reached previously during program operation.

### 13.2 Alarm messages

Alarm messages, e.g. "TEMP. LIMIT" when exceeding the tolerance limit, are shown in Display 2 only in Normal Display.

A buzzer can be activated / deactivated in the user level (chap. 10). It can be reset by pressing the **EXIT** button. The alarm text shown in Normal Display goes off only if the cause of the alarm does not exist any longer.

## 14. Temperature safety devices

### 14.1 Over temperature protective device (class 1)

The chamber is equipped with an internal temperature safety device class 1 acc. to DIN 12880:2007. It serves to protect the chamber and prevents dangerous conditions caused by major defects.

If a temperature of about 110 °C / 230°F is reached, the over temperature protective device permanently turns off the chamber. The user cannot restart the device again. The protective cut-off device is located internally. Only a service specialist can replace it. Therefore, please contact an authorized service provider or BINDER Service.

### 14.2 Safety controller (temperature safety device class 3.1)

The chamber is equipped with an electronic safety controller (over temperature safety device class 3.1 acc. to DIN 12880:2007). This second, electrically independent temperature controller takes over at a selectable set point in case of a faulty condition. It serves to protect the charging material against extremely high temperatures.

The safety controller serves to protect the chamber, its environment and the material under treatment from excess temperatures. In case of error the temperature of the inner chamber will be limited to the set value. Please observe the DGUV guidelines 213-850 on safe working in laboratories (formerly BGI/GUV-I 850-0, BGR/GUV-R 120 or ZH 1/119, issued by the employers' liability insurance association) (for Germany).

The message "TEMP. LIMIT" on the controller Display 2 indicates safety controller activity. If the buzzer has been activated in the User Level (chap. 10), there is an audible alert. The safety controller controls the chamber to the entered safety controller set-point until the temperature inside the chamber returns below this temperature and until you then reset the alarm message with the EXIT button.

The safety controller set-point type and set-point can be set in the user level (chap. 10) of the program controller.

### Safety controller set-point types

Setting in the user level (chap. 10) of the RD3 program controller.

<b>Limit</b>	<p>Absolute maximum permitted temperature value.</p> <p>Example:</p> <p>Temperature set-point 40 °C / 104 °F</p> <p>Limit value (safety controller set-point) set to 42 °C.</p>
<b>Offset</b>	<p>Maximum over temperature above the active temperature set point. The maximum temperature changes internally and automatically with every set-point change it.</p> <p>Example:</p> <p>Temperature set-point 40 °C / 104 °F</p> <p>Offset value (safety controller set-point) set to 2 °C.</p>

	<p>Regularly check the safety controller setting for set-point type “Limit” or “Offset”</p> <ul style="list-style-type: none"> <li>• in Fixed value operation mode according to the entered set-point temperature value</li> <li>• in Program mode according to the highest temperature value of the selected temperature program</li> </ul> <p>Set the safety controller set-point by approx. 2 °C to 5 °C above the desired temperature set-point.</p>
-----------------------------------------------------------------------------------	----------------------------------------------------------------------------------------------------------------------------------------------------------------------------------------------------------------------------------------------------------------------------------------------------------------------------------------------------------------------------------------------------------------------------------------------------------

## 15. Defrosting during refrigerating operation

BINDER cooling incubators are very diffusion-proof. To ensure high temperature precision there is no automatic cyclic defrosting device. The DCT™ refrigerating system largely avoids icing of the evaporation plates. However, at very low temperatures the moisture in the air can condense on the evaporator plates leading to icing.

	<p>Always close the door properly.</p>
-------------------------------------------------------------------------------------	----------------------------------------

- **Operation with temperature set-points above +5 °C / 41 °F at an ambient temperature of 25 °C / 77 °F:**

The air defrosts the ice cover automatically. Defrosting is continually performed.

- **Operation with temperature set-points below +5 °C / 41 °F:**

Icing on the evaporator is possible. Defrost the chamber manually.

	<p>With temperature set-points &lt; +5 °C / 41 °F, regularly defrost the chamber manually:</p> <ul style="list-style-type: none"> <li>• Set the temperature to 40 °C / 104 °F (in Fixed value entry mode)</li> <li>• Let the chamber operate for about 30 minutes with the door closed.</li> </ul>
-------------------------------------------------------------------------------------	----------------------------------------------------------------------------------------------------------------------------------------------------------------------------------------------------------------------------------------------------------------------------------------------------

	<p>Excessive frosting of the evaporator is indicated by reduced refrigerating performance.</p>
-------------------------------------------------------------------------------------	------------------------------------------------------------------------------------------------

	<p>The cooling power decreases when the fan speed is reduced to 20% or below.</p>
-------------------------------------------------------------------------------------	-----------------------------------------------------------------------------------

## 16. Options

### 16.1 APT-COM™ 4 Multi Management Software (option)

The chamber is regularly equipped with a serial interface RS 422 (13) that can connect the BINDER APT-COM™ 4 Multi Management Software. The connection to a computer is established using the chamber interface via an interface converter.



Confirm that the interface mode is correctly set to "Modbus" in the user level (chap. 10).

The actual temperature, and fan speed values are given in adjustable intervals. Programming can be performed graphically via PC. Up to 100 chambers can be cross linked. For further information, refer to the APT-COM™ 4 operating manual.

Pin allocation of the RS 422 interface (13) at the chamber rear:	Pin 2:	RxD (+)
	Pin 3:	TxD (+)
	Pin 4:	RxD (-)
	Pin 5:	TxD (-)
	Pin 7:	Ground

### 16.2 Data logger kit (option)

The BINDER Data Logger Kit offers an independent long-term measuring system for temperature, available for different temperature ranges.

The BINDER Data Logger is equipped with a keyboard and a large LCD display, alarm functions and a real-time function. Measurement data are recorded in the Data Logger and can be read out after the measurement via the RS232 interface of the Data Logger. It offers a programmable measuring interval and permits storing up to 64000 measuring values. Reading out is done with the Data Logger evaluation software. You can give out a combined alarm and status protocol directly to a serial printer.



**Data Logger Kit T 220:** Measuring sensor for the temperature values of the chamber: Temperature range -90 °C / 194 °F up to +220 °C / 428 °F.



For detailed information on installation and operation of the BINDER Data Logger, please refer to the mounting instructions Art. No. 7001-0204 and to the original user manual of the manufacturer, supplied with the data logger.

## 17. Maintenance, cleaning, and service

### 17.1 Maintenance intervals, service

 	 <b>DANGER</b>
<p><b>Electrical hazard.</b></p> <p><b>Danger of death.</b></p> <ul style="list-style-type: none"> <li>⊗ The chamber must NOT become wet during operation or maintenance works.</li> <li>⊗ Do NOT remove the rear panel of the chamber.</li> <li>➤ Before conducting maintenance work, turn off the chamber at the main power switch and disconnect the power plug.</li> <li>➤ General maintenance work must be conducted by licensed electricians or experts authorized by BINDER.</li> <li>➤ Maintenance work at the refrigeration system must only be conducted by qualified personnel who underwent training in accordance with EN 13313:2010 (e.g. a refrigeration technician with certified expert knowledge acc. to regulation 303/2008/EC). Follow the national statutory regulations.</li> </ul>	

Ensure regular maintenance work is performed at least once a year and that the legal requirements are met regarding the qualifications of service personnel, scope of testing and documentation. All work on the refrigeration system (repairs, inspections) must be documented.

	The warranty becomes void if maintenance work is conducted by non-authorized personnel.
-------------------------------------------------------------------------------------	-----------------------------------------------------------------------------------------

	Replace the door gasket only when cold. Otherwise, the door gasket may become damaged.
-------------------------------------------------------------------------------------	----------------------------------------------------------------------------------------

With an increased amount of dust in the ambient air, clean the condenser fan (by suction or blowing) several times a year.



We recommend taking out a maintenance agreement. Please consult BINDER Service.

BINDER telephone hotline:	+49 (0) 7462 2005 555
BINDER fax hotline:	+49 (0) 7462 2005 93555
BINDER e-mail hotline:	service@binder-world.com
BINDER service hotline USA:	+1 866 885 9794 or +1 631 224 4340 x3 (toll-free in the USA)
BINDER service hotline Asia Pacific:	+852 390 705 04 or +852 390 705 03
BINDER service hotline Russia and CIS	+7 495 988 15 16
BINDER Internet website	<a href="http://www.binder-world.com">http://www.binder-world.com</a>
BINDER address	BINDER GmbH, post office box 102, D-78502 Tuttlingen

International customers, please contact your local BINDER distributor.

## 17.2 Cleaning and decontamination

Clean the chamber after each use to avoid potential corrosion damage by ingredients of the test material.

	 <b>DANGER</b>
	<p><b>Electrical hazard.</b></p> <p><b>Danger of death.</b></p> <ul style="list-style-type: none"> <li>⊘ Do NOT spill water or cleaning agents over the inner and outer surfaces.</li> <li>➤ Before cleaning, turn off the chamber at the main power switch and disconnect the power plug.</li> <li>➤ Completely dry the chamber before turning it on again.</li> </ul>

### 17.2.1 Cleaning

Disconnect the chamber from the power supply before cleaning. Disconnect the power plug.

	<p>The interior of the chamber must be kept clean. Thoroughly remove any residues of charging material</p>
-----------------------------------------------------------------------------------	------------------------------------------------------------------------------------------------------------

Wipe the surfaces with a moistened towel. In addition, you can use the following cleaning agents:

Exterior surfaces inner chamber shelves door gaskets	Standard commercial cleaning detergents free from acid or halides. Alcohol based solutions. We recommend using the neutral cleaning agent Art. No. 1002-0016.
Instrument panel	Standard commercial cleaning detergents free from acid or halides. We recommend using the neutral cleaning agent Art. No. 1002-0016.
Zinc coated hinge parts rear chamber wall	Standard commercial cleaning detergents free from acid or halides. Do NOT use a neutral cleaning agent on zinc coated surfaces.

Do not use cleaning agents that may cause a hazard due to reaction with components of the device or the charging material. If there is doubt regarding the suitability of cleaning products, please contact BINDER service.

	<p>We recommend using the neutral cleaning agent Art. No. 1002-0016 for a thorough cleaning.</p> <p>Any corrosive damage that may arise following use of other cleaning agents is excluded from liability by BINDER GmbH.</p> <p>Any corrosive damage caused by a lack of cleaning, is excluded from liability by BINDER GmbH.</p>
-------------------------------------------------------------------------------------	------------------------------------------------------------------------------------------------------------------------------------------------------------------------------------------------------------------------------------------------------------------------------------------------------------------------------------

	<b>CAUTION</b>
	<p><b>Danger of corrosion.</b></p> <p><b>Damage to the chamber.</b></p> <ul style="list-style-type: none"> <li>⊘ Do NOT use acidic or chlorine cleaning detergents.</li> <li>⊘ Do NOT use a neutral cleaning agent on other kind of surfaces e.g., the zinc coated hinge parts or the rear chamber wall.</li> </ul>

	<p>For surface protection, perform cleaning as quickly as possible.</p> <p>After cleaning completely remove any cleaning agents from the surfaces with a moistened towel. Let the chamber dry.</p>
-----------------------------------------------------------------------------------	----------------------------------------------------------------------------------------------------------------------------------------------------------------------------------------------------



	<p>Soapsuds may contain chlorides and must therefore NOT be used for cleaning.</p>
-----------------------------------------------------------------------------------	------------------------------------------------------------------------------------

	<p>With every cleaning method, always use adequate personal safety controls.</p>
-----------------------------------------------------------------------------------	----------------------------------------------------------------------------------

Following cleaning, leave the chamber door open or remove the access port plugs.

	<p>The neutral cleaning agent may cause health problems in contact with skin and if ingested. Follow the operating instructions and safety hints labeled on the bottle of the neutral cleaning agent.</p>
-----------------------------------------------------------------------------------	-----------------------------------------------------------------------------------------------------------------------------------------------------------------------------------------------------------

Recommended precautions: To protect the eyes use sealed protective goggles. Suitable protective gloves with full contact: butyl or nitrile rubber, penetration time >480 minutes.

	<p style="text-align: center;"> <b>CAUTION</b></p> <p><b>Contact with skin, ingestion.</b></p> <p><b>Skin and eye damage due to chemical burns.</b></p> <ul style="list-style-type: none"> <li>Ø Do not ingest. Keep away from food and beverages.</li> <li>Ø Do NOT empty into drains.</li> <li>➤ Wear protective gloves and goggles.</li> <li>➤ Avoid skin contact.</li> </ul>
------------------------------------------------------------------------------------	-------------------------------------------------------------------------------------------------------------------------------------------------------------------------------------------------------------------------------------------------------------------------------------------------------------------------------------------------------------------------------------------------------------------------------------------------------------------

### 17.2.2 Decontamination

The operator must ensure that proper decontamination is performed in case a contamination of the chamber by hazardous substances has occurred.

Disconnect the chamber from the power supply prior to chemical decontamination. Disconnect the power plug.

Do not use decontamination agents that may cause a hazard due to reaction with components of the device or the charging material. If there is doubt regarding the suitability of cleaning products, please contact BINDER service.

#### You can use the following disinfectants:

<p>Inner chamber</p>	<p>Standard commercial surface disinfectants free from acid or halides.</p> <p>Alcohol based solutions.</p> <p>We recommend using the disinfectant spray Art. No. 1002-0022.</p>
----------------------	----------------------------------------------------------------------------------------------------------------------------------------------------------------------------------

	<p>For chemical disinfection, we recommend using the disinfectant spray Art. No. 1002-0022.</p> <p>Any corrosive damage that may arise following use of other disinfectants is excluded from liability by BINDER GmbH.</p>
-------------------------------------------------------------------------------------	----------------------------------------------------------------------------------------------------------------------------------------------------------------------------------------------------------------------------



With every decontamination method, always use adequate personal safety controls.

In case of contamination of the interior by biologically or chemically hazardous material, there are two possible procedures depending on the type of contamination and charging material.

- (1) Spray the inner chamber with an appropriate disinfectant.



Before start-up, the chamber must be absolutely dry and ventilated, as explosive gases may form during the decontamination process.

- (2) If necessary, have strongly contaminated inner chamber parts removed by an engineer for cleaning, or have them exchanged. Sterilize the inner chamber parts in a sterilizer or autoclave.



In case of eye contact, the disinfectant spray may cause eye damage due to chemical burns. Follow the operating instructions and safety hints labeled on the bottle of the disinfectant spray.

Recommended precautions: To protect the eyes use sealed protective goggles.

	 <b>CAUTION</b>
<p><b>Eye contact.</b></p> <p><b>Eye damage due to chemical burns.</b></p> <p>Ø Do NOT empty into drains.</p> <p>➤ Wear protective goggles.</p>	



After using the disinfectant spray, allow the chamber to dry thoroughly, and aerate it sufficiently.

### 17.3 Sending the chamber back to BINDER GmbH

If you return a BINDER product to us for repair or any other reason, we will only accept the product upon presentation of an authorization number that has previously been issued to you. An authorization number will be issued after receiving your complaint either in writing or by telephone **prior** to your sending the BINDER product back to us. The authorization number will be issued following receipt of the information below:

- BINDER product type and serial number
- Date of purchase
- Name and address of the dealer from which you bought the BINDER product
- Exact description of the defect or fault
- Complete address, contact person and availability of that person
- Exact location of the BINDER product in your facility
- A contamination clearance certificate (chap. 23) must be faxed in advance

The authorization number must be applied to the packaging in such a way that it can be easily recognized or be recorded clearly in the delivery documents.



For security reasons we cannot accept a chamber delivery if it does not carry an authorization number.

**Return address:** BINDER GmbH      Gänsäcker 16  
 Abteilung Service      78502 Tuttlingen  
 Germany



## 18. Disposal

### 18.1 Disposal of the transport packing

Packing element	Material	Disposal
Straps to fix packing on pallet	Plastic	Plastic recycling
Wooden transport box (option) with metal screws	Non-wood (compressed matchwood, IPPC standard)	Wood recycling
	Metal	Metal recycling
Pallet	Solid wood (IPPC standard)	Wood recycling
Shipping box with metal clamps	Cardboard	Paper recycling
	Metal	Metal recycling
Top cover	Cardboard	Paper recycling
Edge protection	Styropor® or PE foam	Plastic recycling
Protection of doors and racks	PE foam	Plastic recycling
Bag for operating manual	PE foil	Plastic recycling
Insulating air cushion foil (packing of optional accessories)	PE foil	Plastic recycling

If recycling is not possible, all packing parts can also be disposed of with normal waste.

### 18.2 Decommissioning

Turn off the main power switch (1). Disconnect the chamber from the power supply.

	When switching off the main power switch ON / OFF (1), the stored parameters remain saved.
-------------------------------------------------------------------------------------	--------------------------------------------------------------------------------------------

- Temporal decommissioning: See indications for appropriate storage, chap. 3.3.
- Final decommissioning: Dispose of the chamber as described in chap. 18.3 to 18.5.

### 18.3 Disposal of the chamber in the Federal Republic of Germany

According to Annex I of Directive 2012/19/EU of the European Parliament and of the Council on waste electrical and electronic equipment (WEEE), BINDER devices are classified as “monitoring and control instruments” (category 9) only intended for professional use“. They must not be disposed of at public collecting points.

The chambers bear the symbol for the marking of electrical and electronic equipment manufactured / placed on the market in the EC after 13 August 2005 and be disposed of in separate collection according to Directive 2012/19/EU on waste electrical and electronic equipment (WEEE) and German national law for electrical and electronic equipment (Elektro- und Elektronikgerätegesetz, ElektroG). WEEE marking: crossed-out wheeled bin with solid bar under. A significant part of the materials must be recycled in order to protect the environment.

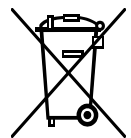



At the end of the device's service life, have the chamber disposed of according to the German national law for electrical and electronic equipment (Elektro- und Elektronikgerätegesetz, ElektroG from 20 October 2015, BGBl. I p. 1739) or contact BINDER service who will organize taking back and disposal of the chamber according to the German national law for electrical and electronic equipment (Elektro- und Elektronikgerätegesetz, ElektroG from 20 October 2015, BGBl. I p. 1739).

	<b>CAUTION</b>
	<p><b>Violation against existing law.</b></p> <ul style="list-style-type: none"> <li>∅ Do NOT dispose of BINDER devices at public collecting points.</li> <li>➤ Have the device disposed of professionally at a recycling company which is certified according to the German national law for electrical and electronic equipment (Elektro- und Elektronikgerätegesetz, ElektroG from 20 October 2015, BGBl. I p. 1739).</li> <li style="text-align: center;"><i>or</i></li> <li>➤ Instruct BINDER Service to dispose of the device. The general terms of payment and delivery of BINDER GmbH apply, which were valid at the time of purchasing the chamber.</li> </ul>

Certified companies disassemble waste (used) BINDER equipment in primary substances for recycling according to Directive 2012/19/EU. The devices must be free from toxic, infectious or radioactive substances in order to eliminate any health hazards to the employees of the recycling companies.

	<p>Prior to handing the chamber over to a recycling company, it is the user's responsibility that it is free from toxic, infectious or radioactive substances.</p> <p>Prior to disposal, clean all introduced or residual toxic substances from the unit.</p> <p>Prior to disposal, disinfect the unit from all sources of infection. Be aware that sources of infection may also be located outside the inner chamber.</p> <p>If you cannot safely remove all toxic substances and sources of infection from the unit, dispose of it as special waste according to national law.</p> <p>Fill out the contamination clearance certificate (chap. 23) and enclose it with the unit.</p>
-----------------------------------------------------------------------------------	----------------------------------------------------------------------------------------------------------------------------------------------------------------------------------------------------------------------------------------------------------------------------------------------------------------------------------------------------------------------------------------------------------------------------------------------------------------------------------------------------------------------------------------------------------------------------------------------------------------------------------------------------------------------------------------

 	<b>WARNING</b>
	<p><b>Contamination of the device with toxic, infectious or radioactive substances.</b></p> <p><b>Danger of intoxication.</b></p> <p><b>Danger of infection.</b></p> <ul style="list-style-type: none"> <li>∅ NEVER take a chamber contaminated with toxic substances or sources of infection for recycling according to Directive 2012/19/EU.</li> <li>➤ Prior to disposal, remove all toxic substances and sources of infection from the chamber.</li> <li>➤ A chamber from which all toxic substances or sources of infection cannot be safely removed must be considered as "special" waste according to national law. Dispose of it accordingly.</li> </ul>

The refrigerant used R134A (1,1,1,2-tetrafluoroethane) is not inflammable at ambient pressure. It must not be exposed to the environment. In Europe, recovery of the refrigerant R134A (GWP 1300) is mandatory according to regulation No. 842/2006/EC. Ensure the compliance with the applicable legal requirements regarding qualification of staff, disposal, and documentation.

## 18.4 Disposal of the chamber in the member states of the EC except for the Federal Republic of Germany

According to Annex I of Directive 2012/19/EU of the European Parliament and of the Council on waste electrical and electronic equipment (WEEE), BINDER devices are classified as "monitoring and control instruments" (category 9) only intended for professional use". They must not be disposed of at public collecting points.

The chambers bear the symbol for the marking of electrical and electronic equipment manufactured / placed on the market in the EC after 13 August 2005 and be disposed of in separate collection according to the Directive 2012/19/EU on waste electrical and electronic equipment (WEEE). WEEE marking: crossed-out wheeled bin with solid bar under.

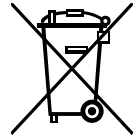



At the end of the device's service life, notify the distributor who sold you the device, who will take back and dispose of the chamber according to the Directive 2012/19/EU on waste electrical and electronic equipment (WEEE).

	<b>CAUTION</b>
	<p><b>Violation against existing law.</b></p> <ul style="list-style-type: none"> <li>Ø Do NOT dispose of BINDER devices at public collecting points.</li> <li>➤ Have the device disposed of professionally at a recycling company that is certified according to conversion of the Directive 2012/19/EU into national law. <i>or</i></li> <li>➤ Instruct the distributor who sold you the device to dispose of it. The agreements apply that were agreed with the distributor when purchasing the chamber (e.g. his general terms of payment and delivery).</li> <li>➤ If your distributor is not able to take back and dispose of the chamber, please contact BINDER service.</li> </ul>



Certified companies disassemble waste (used) BINDER equipment in primary substances for recycling according to Directive 2012/19/EU. The devices must be free from toxic, infectious or radioactive substances in order to eliminate any health hazards to the employees of the recycling companies.

	<p>Prior to handing the chamber over to a recycling company, it is the user's responsibility that it is free from toxic, infectious or radioactive substances.</p> <p>Prior to disposal, clean all introduced or residual toxic substances from the chamber.</p> <p>Prior to disposal, disinfect the chamber from all sources of infection. Be aware that sources of infection may also be located outside the inner chamber.</p> <p>If you cannot safely remove all sources of infection and toxic substances from the chamber, dispose of it as special waste according to national law.</p> <p>Fill out the contamination clearance certificate (chap. 23) and enclose it with the chamber.</p>
-------------------------------------------------------------------------------------	----------------------------------------------------------------------------------------------------------------------------------------------------------------------------------------------------------------------------------------------------------------------------------------------------------------------------------------------------------------------------------------------------------------------------------------------------------------------------------------------------------------------------------------------------------------------------------------------------------------------------------------------------------------------------------------------------

 	 <b>WARNING</b>
	<p><b>Contamination of the device with toxic, infectious or radioactive substances.</b></p> <p><b>Danger of intoxication.</b></p> <p><b>Danger of infection.</b></p> <ul style="list-style-type: none"> <li>Ø NEVER take a chamber contaminated with toxic substances or sources of infection for recycling according to Directive 2012/19/EU.</li> <li>➤ Prior to disposal, remove all toxic substances and sources of infection from the chamber.</li> <li>➤ A chamber from which all toxic substances or sources of infection cannot be safely removed must be considered as "special" waste according to national law. Dispose of it accordingly.</li> </ul>

The refrigerant used R134A (1,1,1,2-tetrafluoroethane) is not inflammable at ambient pressure. It must not be exposed to the environment. In Europe, recovery of the refrigerant R134A (GWP 1300) is mandatory according to regulation No. 842/2006/EC. Ensure the compliance with the applicable legal requirements regarding qualification of staff, disposal, and documentation.

## 18.5 Disposal of the chamber in non-member states of the EC

 	<b>CAUTION</b>
	<p><b>Alteration of the environment.</b></p> <ul style="list-style-type: none"><li>➤ For final decommissioning and disposal of the chamber, please contact BINDER service.</li><li>➤ Follow the statutory regulations for appropriate, environmentally friendly disposal.</li></ul>

The main board of the cooling incubator includes a lithium cell. Please dispose of it according to national regulations.

The refrigerant used R134A (1,1,1,2-tetrafluoroethane) is not inflammable at ambient pressure. It must not be exposed to the environment. In Europe, recovery of the refrigerant R134A (GWP 1300) is mandatory according to regulation No. 842/2006/EC. Ensure the compliance with the applicable legal requirements regarding qualification of staff, disposal, and documentation.

## 19. Troubleshooting

Fault description	Possible cause	Required measures
<b>Heating</b>		
Set-point temperature is not reached after specified time.	Chamber door not properly closed.	Completely close chamber door.
	Door gasket defective.	Replace door gasket.
	Controller not adjusted, or adjustment interval exceeded.	Calibrate and adjust controller.
Chamber heating permanently, set-point not maintained.	Controller defective.	Contact BINDER service.
	Semiconductor relay defective	
	Controller not adjusted, or adjustment interval exceeded.	Calibrate and adjust controller.
Chamber doesn't heat up. LED (3a) "Heating active" lit.	Heating element defective.	Contact BINDER service.
	Semiconductor relay defective.	
Chamber doesn't heat up. LED (3a) "Heating active" not lit.	Safety controller has turned off the chamber. Limit temperature reached. Safety controller set too low.	Allow the chamber to cool down and press the "EXIT" button. Check temperature set-point and setting of safety controller. If appropriate, select suitable limit value.
	Safety controller defective.	Contact BINDER service.
	Semiconductor relay defective.	
	Controller defective.	
Chamber without function.	No power supply.	Check connection to power supply.
	Wrong voltage.	Check power supply for voltage of 100-120V or 200-240V.
	Chamber fuse has responded.	Check chamber fuse and replace it if appropriate. If it responds again, contact BINDER service.
	Controller defective.	Contact BINDER service.
	Nominal temperature exceeded by 10° due to chamber failure. Over temperature protective device (class 1) responds.	
Deviations from the indicated heating-up times.	Chamber fully loaded.	Load the chamber less or consider longer heating-up times.
<b>Refrigerating performance</b>		
Low or no refrigerating performance.	Ambient temperature above 25 °C / 77°F (chap. 3.4).	Select cooler place of installation.
	Compressor not turned on.	Contact BINDER service.
	Electro-valves defective.	
	No or not enough refrigerant.	
	Too much external heat load.	Reduce heat load.

Fault description	Possible cause	Required measures
<b>Controller</b>		
Program duration longer than programmed.	Inappropriate tolerances have been programmed.	For rapid transition phases, do NOT program tolerance limits in order to allow maximum heating speed.
Program stops one section too early.	Program line is incomplete.	When programming, define the end value of the desired cycle by adding an additional section with a section time of at least one minute (with setting "ramp").
Programs have been deleted.	Change from 2 programs to 1 program or vice-versa	When changing, ensure that the programs are no longer needed.
The controller returns to Normal Display from any level.	No button was pressed for more than 120 sec.	Repeat entries, enter the values rapidly.
Message RANGE ERROR CH1 in Normal Display in Display 2	Sensor rupture between sensor and controller, or Pt 100 sensor defective.	Contact BINDER service.
Ramp temperature transitions are only realized as steps.	Set-point programming type set to "Step" in the User level (chap. 10).	Set the set-point programming type to setting "Ramp" in the User level (chap. 10).



Only qualified service personnel authorized by BINDER must perform repair. Repaired chambers must comply with the BINDER quality standards.

## 20. Technical description

### 20.1 Factory calibration and adjustment

This chamber was calibrated and adjusted in the factory. Calibration and adjustment were performed using standardized test instructions, according to the QM DIN EN ISO 9001 system applied by BINDER (certified since December 1996 by TÜV CERT). All test equipment used is subject to the administration of measurement and test equipment that is also constituent part of the BINDER QM DIN EN ISO 9001 systems. They are controlled and calibrated to a DKD-Standard at regular intervals.



Repeated calibrations are recommended in periods of 12 months.

### 20.2 Over current protection

The chambers are protected by a chamber-protection against over current, accessible from the outside. It is located at the rear of the chamber below the strain relief of the power cord. The fuse holder is equipped with a fuse clip 5mm x 20 mm (cUL-Version 6.3 x32 mm). Replace this fuse only with a substitute of the same ratings. Refer to the technical data of the respective device type. If this fuse is blown, please inform an electronic engineer or BINDER service.

### 20.3 Definition of usable volume

The usable volume illustrated below is calculated as follows:

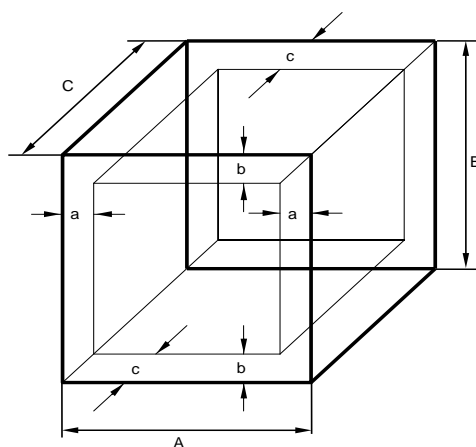

A, B, C = internal dimensions (W, H, D)

a, b, c = wall separation

$$a = 0.1 \cdot A$$

$$b = 0.1 \cdot B$$

$$c = 0.1 \cdot C$$

$$V_{USE} = (A - 2 \cdot a) \cdot (B - 2 \cdot b) \cdot (C - 2 \cdot c)$$

Figure 8: Determination of the usable volume

**The technical data refers to the defined usable volume.**



Do NOT place samples outside this usable volume.

Do NOT load this volume by more than half to enable sufficient airflow inside the chamber.

Do NOT divide the usable volume into separate parts with large area samples.

Do NOT place samples too close to each other in order to permit circulation between them and thus obtain a homogenous distribution of temperature and humidity.

## 20.4 KB 23 / KB 23-UL (E3.1) technical data

<b>Exterior dimensions</b>			
Width, net		mm / inch	435 / 17.13
Height, gross (incl. feet)		mm / inch	620 / 24.41
Depth, net		mm / inch	520 / 20.47
Depth, gross (incl. door handle, I-panel, connection, and 30 mm for cable)		mm / inch	600 / 23.62
Wall clearance (minimum)		mm / inch	100 / 3.94
Wall clearance door open (minimum)		mm / inch	100 / 3.94
<b>Doors</b>			
Number of doors			1
Number of inner glass doors			1
<b>Interior dimensions</b>			
Width		mm / inch	222 / 8.74
Height		mm / inch	330 / 12.99
Depth		mm / inch	277 / 10.91
Interior volume		l / cu.ft.	10 / 0.35
Steam space volume			l / cu.ft.
<b>Racks</b>			
Quantity of racks (regular)			2
Quantity of racks (max.)			3
Maximum load per rack		Kg / lbs	12 / 26
Maximum permitted total load		Kg / lbs	25 / 55
<b>Weight</b>			
Weight (empty)		Kg / lbs	44 / 97
<b>Temperature data</b>			
Temperature range		°C	0 to +100
		°F	4 to 212
Temperature fluctuation	at 5 °C	± K	0.2
	at 40 °C	± K	0.2
Temperature uniformity (variation)	at 5 °C	± K	0.7
	at 25 °C	± K	0.3
	at 40 °C	± K	0.3
Heating up time	to 40 °C	min	11
Cooling down time from 40 °C	to 5 °C	min	61
Recovery time after doors were open for 30 sec.	at 5 °C	min	5
	at 40 °C	min	2
<b>Electrical data (model version KB023-230V)</b>			
IP system of protection acc. to EN 60529			20
Nominal voltage (±10 %) at 50 Hz power frequency		V	230
Current type			1N~
Power plug			Grounded plug
Nominal power		kW	0.34
Overvoltage category acc. to IEC 61010-1			II
Pollution degree acc. to IEC 61010-1			2
Chamber fuse 5x20 mm 230V, time-lag T, external		Amp	10



Different electrical data for KB 23-UL constructed for the USA and Canada			
Nominal voltage ( $\pm 10\%$ ) at 60 Hz power frequency		V	115
Power plug		NEMA	5-15P
Chamber fuse 6,3 x 32 mm, 250V, super-time-lag TT, external		Amp	12.5
Additional temperature fuse, internal			class 1 (DIN 12880)
Environment-specific data			
Energy consumption	at 5 °C	Wh/h	50
	at 40 °C	Wh/h	60
Filling weight of refrigerant R 134A (GWP 1300)		Kg / lbs	0.075

All technical data is specified for unloaded chambers with standard equipment at an ambient temperature of  $+22\text{ °C} \pm 3\text{ °C} / 71.6\text{ °F} \pm 5.4\text{ °F}$  and a power supply voltage fluctuation of  $\pm 10\%$ . Technical data is determined in accordance to BINDER Factory Standard Part 1:2015 following DIN 12880:2007.

**All indications are average values, typical for chambers produced in series. We reserve the right to change technical specifications at any time.**

	If the chamber is fully loaded, the specified heating up and cooling down times may vary according to the load.
-----------------------------------------------------------------------------------	-----------------------------------------------------------------------------------------------------------------

## 20.5 Equipment and Options (extract)

	To operate the cooling incubator, use only original BINDER accessories or accessories / components from third-party suppliers authorized by BINDER. The user is responsible for any risk arising from using unauthorized accessories.
-------------------------------------------------------------------------------------	---------------------------------------------------------------------------------------------------------------------------------------------------------------------------------------------------------------------------------------

Regular equipment
RD3 Multifunction program controller with digital display
Temperature safety controller class 3.1 acc. to DIN 12880:2007
Communication interface RS 422
Inner glass door
DCT™ refrigerating system with refrigerant R134a

Options / accessories
Additional access ports 10 mm / 0.39 in / 30 mm / 1.18 in or 50 mm / 1.97 in with silicone plug
Rack lockings (4 pc.)
Additional shelf, stainless steel
Rubber pads for safe stacking (4 pieces)
Data Logger Kit T 220
Lockable door
Factory calibration certificate
Spatial temperature measurement with certificate
Qualification folder

## 20.6 Spare parts and accessories (extract)

	<p>BINDER GmbH is responsible for the safety features of the chamber only, provided skilled electricians or qualified personnel authorized by BINDER perform all maintenance and repair, and if components relating to chamber safety are replaced in the event of failure with original spare parts. The user is responsible for any risks arising from using unauthorized accessories/components.</p>
-----------------------------------------------------------------------------------	---------------------------------------------------------------------------------------------------------------------------------------------------------------------------------------------------------------------------------------------------------------------------------------------------------------------------------------------------------------------------------------------------------

Description	Art.-No.
Shelf, stainless steel	6004-0051
Perforated shelf, stainless steel	6004-0052
Door gasket silicone	6005-0090
Rubber pads for safe stacking (4 pieces)	8012-0001
Chamber fuse 5x20mm 250V 10 Amp time-lag (T) KB 23 (230 V)	5006-0088
Chamber fuse 6,3 x 32 mm / 250 V / super-time-lag (TT) KB 23-UL	5006-0045
Securing elements for additional fastening of racks (4 pieces)	8012-0531
Plug for silicon access port d30	6016-0035
Temperature safety device, class 1 (complete)	8009-0335
Temperature sensor Pt 100 bent-off	5002-0031
Data Logger Kit T 220	8012-0715
Neutral cleaning agent, 1 kg	1002-0016

Validation Service	Art.-No.
Qualification folder IQ-OQ	8012-0873
Qualification folder IQ-OQ-PQ	8012-0960
Execution of IQ-OQ	DL410200
Execution of IQ-OQ-PQ	DL440500

Calibration service	Art.-No.
Calibration of temperature including certificate (1 measuring point)	DL300101
Spatial temperature measurement including certificate (9 measuring points)	DL300109
Spatial temperature measurement including certificate (18 measuring points)	DL300118
Spatial temperature measurement including certificate (27 measuring points)	DL300127

## 20.7 KB / KB-UL 23 dimensions

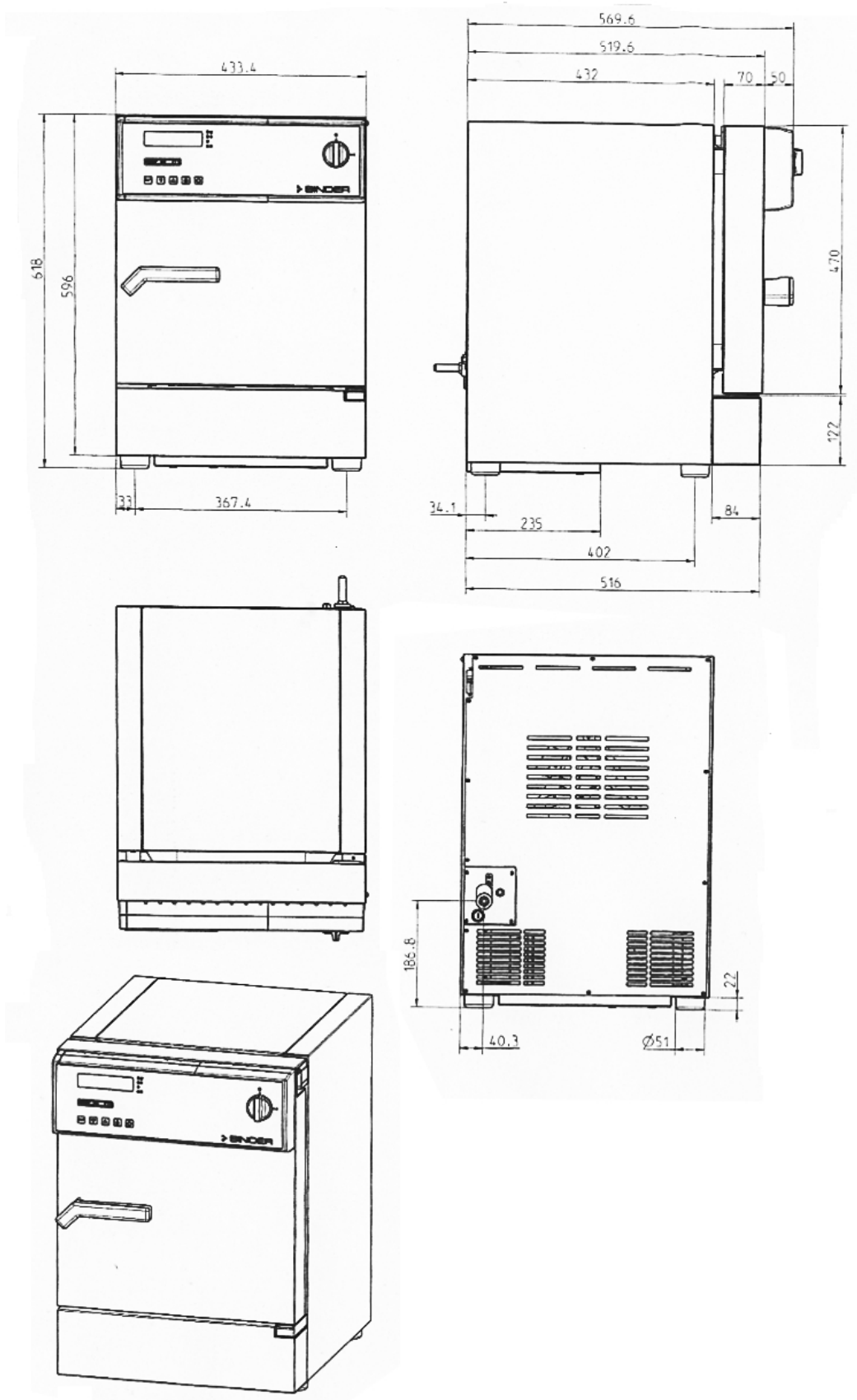

## 21. Certificates and declarations of conformity

### 21.1 EU Declaration of Conformity

  
 Best conditions for your success

	<b>EU-Konformitätserklärung / EU Declaration of Conformity / Déclaration de conformité UE / Declaración de conformidad UE / Dichiarazione di conformità UE / Декларация соответствия EU</b>
Hersteller / Manufacturer / Fabricant / Fabricante / Fabbicante / Производитель	BINDER GmbH
Anschrift / Address / Adresse / Dirección / Indirizzo / Адрес	Im Mittleren Ösch 5, 78532 Tuttlingen, Germany
Produkt / Product / Produit / Producto / Prodotto / Продукт	Kühlinkubatoren mit Kompressortechnologie Cooling incubators with compressor technology Incubateurs réfrigérés avec technologie de compresseur Incubadoras refrigeradas con tecnología de compresores Incubatori refrigerati con tecnologia a compressore Инкубаторы с охлаждением с компрессорной технологией
Typenbezeichnung / Type / Type / Tipo / Tipo / Тип	KB 23

Die oben beschriebenen Maschinen sind konform mit folgenden EG/EU-Richtlinien (gemäß Veröffentlichung im Amtsblatt der europäischen Kommission):  
 The machines described above are in conformity with the following EC/EU Directives (as published in the Official Journal of the European Union):  
 Les machines décrites ci-dessus sont conformes aux directives CE/UE suivantes (selon leur publication dans le Journal officiel de l'Union européenne):  
 La máquina descrita arriba cumple con las siguientes directivas de la CE/UE (publicados en el Diario oficial de la Unión Europea):  
 Le macchine sopra descritte sono conforme alle seguenti direttive CE/UE (secondo la pubblicazione nella Gazzetta ufficiale della Commissione europea):  
 Машина, указанная выше, полностью соответствует следующим регламентам ЕС/EU (опубликованным в Официальном журнале Европейского Содружества):

- 2006/42/EC**  
 Maschinenrichtlinie 2006/42/EG / Machinery directive 2006/42/EC / Directive Machines 2006/42/EC / Directiva 2006/42/CE (Máquinas) / Direttiva macchine 2006/42/CE / Директива о машинах 2006/42/EC
- 2014/30/EU**  
 EMV-Richtlinie 2014/30/EU / EMC Directive 2014/30/EU / Directive CEM 2014/30/UE / Directiva CEM 2014/30/UE / Direttiva EMC 2014/30/UE / Директива ЭМС 2014/30/EU
- 2011/65/EU**  
 RoHS-Richtlinie 2011/65/EU / RoHS Directive 2011/65/EU / Directive RoHS 2011/65/UE / Directiva RoHS 2011/65/UE / Direttiva RoHS 2011/65/UE / Директива RoHS 2011/65/EU

1 / 3

BINDER GmbH Postfach 102 D-78502 Tuttlingen **Anschrift:** BINDER GmbH Im Mittleren Ösch 5 D-78532 Tuttlingen  
**Kontakt:** Telefon: +49 (0) 74 62 / 20 05 - 0 | Telefax: +49 (0) 74 62 / 20 05 - 100 | info@binder-world.com | www.binder-world.com  
**Geschäftsführung:** Dipl.-Ing. Peter M. Binder | Amtsgericht Stuttgart, HRB 727150 | Sitz der Gesellschaft: Tuttlingen  
**Bankverbindung:** Kreissparkasse Tuttlingen Konto-Nr.: 2266 BLZ: 643 500 70 | IBAN-Code: DE05643 500700 000002266 | SWIFT-Code: SOLA DE S1TUT  
 \$-Account 2202 611 55 | IBAN-Code: DE7464350070 0220 261155 | SWIFT-Code: SOLA DE S1TUT  
 Deutsche Bank Tuttlingen Konto-Nr.: 2 138 709 BLZ: 653 700 75 | IBAN-Code: DE56653 70075 0213870900 | SWIFT-Code: DEUT DE SS603  
 Altgeräte-Entsorgung gemäß WEEE-Reg.-Nr. DE 37004983

Die oben beschriebenen Maschinen entsprechen aufgrund ihrer Konzipierung und Bauart sowie in der von uns in Verkehr gebrachten Ausführung den einschlägigen grundlegenden Sicherheits- und Gesundheitsanforderungen der genannten EG/EU-Richtlinien.

The machines described above are conform to the mentioned EC/EU directives in regard to the relevant safety and health demands due to their conception and style of construction as well as to the version put onto market by us.

Les machines décrites ci-dessus correspondent aux demandes de sécurité et de santé des directives citées de la CE/UE due à leur conception et construction et dans la réalisation mise sur le marché par nous.

Las máquinas descritas arriba se corresponden con los requisitos básicos pertinentes de seguridad y salud de las citadas directivas de la CE/UE debido a su concepción y fabricación, así como a la realización llevada a cabo por nosotros.

Le macchine sopra descritte sono conforme ai requisiti essenziali di sanità e sicurezza pertinenti delle summenzionate direttive CE/UE in termini di progettazione, tipo di costruzione ed esecuzione messa da noi in circolazione.

Машины описано выше, соответствует указанным директивам ЕС/ЕУ в отношении требований соответствующей безопасности и здоровья по концепции и конструкции так же как и версия, применяемая нами на рынке.

Die oben beschriebenen Maschinen tragen entsprechend die Kennzeichnung CE.

The machines described above, corresponding to this, bear the CE-mark.

Les machines décrits ci-dessus, en correspondance, portent l'indication CE.

Las maquinas descritas arriba, en conformidad, llevan la indicación CE.

Le macchine sopra descritte sono contrassegnate dal marchio CE.

Машины описано выше, в соответствии с изложенным выше маркированы знаком CE.

Die oben beschriebenen Maschinen sind konform mit folgenden harmonisierten Normen:

The machines described above are in conformity with the following harmonized standards:

Les machines décrits ci-dessus sont conformes aux normes harmonisées suivantes:

Las maquinas descritas arriba cumplen con las siguientes normas:

Le macchine sopra descritte sono conforme alle seguenti normative armonizzate:

Машины описано выше, полностью соответствуют следующим стандартам:

Sicherheit / Safety / Sécurité / Seguridad / Sicurezza / Нормативы по безопасности
<ul style="list-style-type: none"> <li>• EN ISO 12100:2010 + Corr. 1:2011</li> <li>• EN ISO 13732-1:2008</li> <li>• EN 60204-1:2006 + A1:2009 + Corr. :2010</li> </ul>
EMV / EMC / CEM / CEM / EMC / ЭМС
<ul style="list-style-type: none"> <li>• EN 61326-1:2013</li> </ul>
RoHS
<ul style="list-style-type: none"> <li>• EN 50581:2012</li> </ul>

78532 Tuttlingen, 06.02.2019  
BINDER GmbH



P. M. Binder

Geschäftsführender Gesellschafter  
Managing Director  
Directeur général  
Director general  
Direttore Generale  
Директор



J. Bollaender

Leiter F & E und Dokumentationsbevollmächtigter  
Director R & D and documentation representative  
Chef de service R&D et autorisé de documentation  
Responsable I & D y representante de documentación  
Direttore R & D e responsabile della documentazione  
Глава департамента R&D представитель документации

3 / 3

BINDER GmbH Postfach 102 D-78502 Tuttlingen **Anschrift:** BINDER GmbH Im Mittleren Ösch 5 D-78532 Tuttlingen  
**Kontakt:** Telefon: +49 (0) 74 62 / 20 05 - 0 | Telefax: +49 (0) 74 62 / 20 05 - 100 | info@binder-world.com | www.binder-world.com  
**Geschäftsführung:** Dipl.-Ing. Peter M. Binder | Amtsgericht Stuttgart, HRB 727150 | Sitz der Gesellschaft: Tuttlingen  
**Bankverbindung:** Kreissparkasse Tuttlingen Konto-Nr.: 2266 BLZ: 643 500 70 | IBAN-Code: DE05643 500700 000002266 | SWIFT-Code: SOLA DE S1TUT  
**S-Account** 2202 611 55 | IBAN-Code: DE7464350070 0220 261155 | SWIFT-Code: SOLA DE S1TUT  
**Deutsche Bank Tuttlingen** Konto-Nr.: 2 138 709 BLZ: 653 700 75 | IBAN-Code: DE56653 70075 0213870900 | SWIFT-Code: DEUT DE SS603  
Altgeräte-Entsorgung gemäß WEEE-Reg.-Nr. DE 37004983

## 21.2 Certificate for the GS mark of conformity of the "Deutsche Gesetzliche Unfallversicherung e.V." (German Social Accident Insurance) DGUV

Bescheinigung  
Nr. **NV 15127**  
vom 17.06.2015



### GS-Zertifikat

Name und Anschrift des Bescheinigungsinhabers: (Auftraggeber)	<b>Binder GmbH</b> Im Mittleren Ösch 5 78532 Tuttlingen
Produktbezeichnung:	<b>Klimaschränke      Klima- und Kühlbrutschränke</b>
Typ:	KBF P 240, KBF P 720, KBF LQC 240, KBF LQC 720, KBWF 240, KBWF 720, KBF 115, KBF 240, KBF 720, KMF 115, KMF 240, KMF 720, KBW 240, KBW 400, KBW 720, KB 23, KB 53, KB 115, KB 240, KB 400, KB 720, KBF 1020
Prüfgrundlage:	GS-NV 5:2013/06 Prüfgrundsätze für Kühl- und Gefriermaschinen für Industrie und Gewerbe
Zugehöriger Prüfbericht:	NV 15127
Weitere Angaben:	Das Zertifikat bezieht sich auf die im zugehörigen Prüfbericht beschriebene Ausführung des Produkts.

Das geprüfte Baumuster stimmt mit den in § 21 Absatz 1 des Produktsicherheitsgesetzes genannten Anforderungen überein. Der Bescheinigungsinhaber ist berechtigt, das umseitig abgebildete GS-Zeichen an den mit dem geprüften Baumuster übereinstimmenden Produkten anzubringen. Der Bescheinigungsinhaber hat dabei die umseitig aufgeführten Bedingungen zu beachten.

Diese Bescheinigung einschließlich der Berechtigung zur Anbringung des GS-Zeichens ist gültig bis:  
**16.06.2020**

Weiteres über die Gültigkeit, eine Gültigkeitsverlängerung und andere Bedingungen regelt die Prüf- und Zertifizierungsordnung.



P2204\_D  
11.14

Deutsche Gesetzliche Unfallversicherung (DGUV) e.V.  
Spitzenverband der gewerblichen Berufsgenossenschaften  
und der Unfallversicherungsträger der öffentlichen Hand  
Vereinsregister-Nr. VR 751 B, Amtsgericht Charlottenburg

DGUV Test Prüf- und Zertifizierungsstelle Nahrungsmittel und Verpackung  
Fachbereich Nahrungsmittel  
Dynamostraße 7 – 11 • 68165 Mannheim • Deutschland  
Telefon: +49 (0) 6 21 44 56-34 30 • Fax: +49 (0) 800 1977 553 16625

Rückseite GS-Zertifikat: NV 15127

### GS-Zeichen



Normalausführung

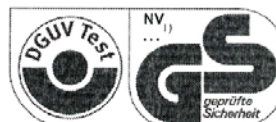

Bei einer Höhe von 20 mm oder weniger  
auch zulässige Ausführung

1)Bescheinigungs-Nummer

1. Der Bescheinigungsinhaber hat die Voraussetzungen einzuhalten, die bei der Herstellung des umseitig genannten Produktes zu beachten sind, um die Übereinstimmung mit dem geprüften Baumuster zu gewährleisten.
2. Die Prüf- und Zertifizierungsstelle des Fachbereichs Nahrungsmittel führt in regelmäßigen Abständen Kontrollmaßnahmen zur Überwachung der Herstellung und rechtmäßigen Verwendung des GS-Zeichens durch.
3. Die für die Herstellung verantwortliche Person hat sich zur Einhaltung der Voraussetzungen nach Nummer 1 und Duldung der Kontrollmaßnahmen verpflichtet.
4. Die Prüf- und Zertifizierungsstelle entzieht dem Bescheinigungsinhaber die Zuerkennung des GS-Zeichens, wenn sich die Anforderungen nach § 21 Absatz 1 Produktsicherheitsgesetz geändert haben oder die Voraussetzungen nach Nummer 1 nicht eingehalten werden.
5. Das GS-Zeichen darf nur verwendet und mit ihm darf nur geworben werden, wenn die Voraussetzungen nach § 22 Produktsicherheitsgesetz erfüllt sind.



## 22. Product registration

# Online Product Registration

Register your BINDER now!

[www.binder-world.com/register](http://www.binder-world.com/register)

The registration is free and takes just a few seconds

Advantages:

- ▶ Short response times if service is needed
- ▶ Fair prices when relocating or installing equipment
- ▶ Calibration as required at no charge in case of recalls
- ▶ Free information on news, product upgrades and accessories

Easy registered in 3 steps:



1. List serial number here:

□□-□□□□□□

2. Go online: [www.binder-world.com/register](http://www.binder-world.com/register)

3. Register serial number

## 23. Contamination clearance certificate

### 23.1 For chambers located outside USA and Canada

#### Declaration regarding safety and health

Erklärung zur Sicherheit and gesundheitlichen Unbedenklichkeit

The German Ordinance on Hazardous Substances (GefStofV), and the regulations regarding safety at the workplace, require that this form be filled out for all products that are returned to us, so that the safety and the health of our employees can be guaranteed.

Die Sicherheit und Gesundheit unserer Mitarbeiter, die Gefahrstoffverordnung GefStofV und die Vorschriften zur Sicherheit am Arbeitsplatz machen es erforderlich, dass dieses Formblatt für alle Produkte, die an uns zurückgeschickt wird.



Note: A repair is not possible without a completely filled out form.  
Ohne Vorliegen des vollständig ausgefüllten Formblattes ist eine Reparatur nicht möglich.

- A completely filled out form must be transmitted via Fax (+49 (0) 7462 2005 93555) or by letter in advance, so that this information is available before the equipment/component part arrives. A second copy of this form must accompany the equipment/component part. In addition, the carrier should be informed.

Eine vollständig ausgefüllte Kopie dieses Formblattes soll per Telefax (Nr. +49 (0) 7462 2005 93555) oder Brief vorab an uns gesandt werden, so dass die Information vorliegt, bevor das Gerät/Bauteil eintrifft. Eine weitere Kopie soll dem Gerät/Bauteil beigelegt sein. Ggf. ist auch die Spedition zu informieren.

- Incomplete information or non-conformity with this procedure will inevitably lead to substantial delays in processing. Please understand the reason for this measure, which lies outside our area of influence and will help us to speed up this procedure.

Unvollständige Angaben oder Nichteinhalten dieses Ablaufs führen zwangsläufig zu beträchtlichen Verzögerungen in der Abwicklung. Bitte haben Sie Verständnis für Maßnahmen, die außerhalb unserer Einflussmöglichkeiten liegen und helfen Sie mit, den Ablauf beschleunigen.

- **Please print and fill out this form completely.**

Bitte unbedingt vollständig ausfüllen!

<b>1.</b>	<b>Unit/ component part / type: / Gerät / Bauteil / Typ:</b>
<b>2.</b>	<b>Serial No./ Serien-Nr.:</b>
<b>3.</b>	<b>Details about utilized substances / biological substances / Einzelheiten über die eingesetzten Substanzen/biologische Materialien:</b>
<b>3.1</b>	<b>Designations / Bezeichnungen:</b>
a)	_____
b)	_____
c)	_____
<b>3.2</b>	<b>Safety measures required for handling these substances / Vorsichtsmaßnahmen beim Umgang mit diesen Stoffen:</b>
a)	_____
b)	_____
c)	_____

<b>3.3 Measures to be taken in case of skin contact or release into the atmosphere / Maßnahmen bei Personenkontakt oder Freisetzung:</b>
a) _____
b) _____
c) _____
d) _____
<b>3.4 Other important information that must be taken into account / Weitere zu beachtende und wichtige Informationen:</b>
a) _____
b) _____
c) _____
<b>4. Declaration on the risk of these substances (please checkmark the applicable items) / Erklärung zur Gefährlichkeit der Stoffe (bitte Zutreffendes ankreuzen) :</b>
<input type="checkbox"/> <b>4.1 For non toxic, non radioactive, biologically harmless materials / für nicht giftige, nicht radioaktive, biologisch ungefährliche Stoffe:</b>
<b>We hereby guarantee that the above-mentioned unit / component part... / Wir versichern, dass o.g. Gerät/Bauteil...</b>
<input type="checkbox"/> Has not been exposed to or contains any toxic or otherwise hazardous substances / weder giftige noch sonstige gefährliche Stoffe enthält oder solche anhaften.
<input type="checkbox"/> That eventually generated reaction products are non-toxic and also do not represent a hazard / auch evtl. entstandene Reaktionsprodukte weder giftig sind noch sonst eine Gefährdung darstellen.
<input type="checkbox"/> Eventual residues of hazardous substances have been removed / evtl. Rückstände von Gefahrstoffen entfernt wurden.
<input type="checkbox"/> <b>4.2 For toxic, radioactive, biologically harmful or hazardous substances, or any other hazardous materials / für giftige, radioaktive, biologisch bedenkliche bzw. gefährliche Stoffe oder anderweitig gefährliche Stoffe.</b>
<b>We hereby guarantee that ... / Wir versichern, dass ...</b>
<input type="checkbox"/> The hazardous substances, which have come into contact with the above-mentioned equipment/component part, have been completely listed under item 3.1 and that all information in this regard is complete / die gefährlichen Stoffe, die mit dem o.g. Gerät/Bauteil in Kontakt kamen, in 3.1 aufgelistet sind und alle Angaben vollständig sind.
<input type="checkbox"/> That the unit /component part has not been in contact with radioactivity / das Gerät/Bauteil nicht mit Radioaktivität in Berührung kam
<b>5. Kind of transport / transporter / Transportweg/Spediteur:</b>
Transport by (means and name of transport company, etc.) Versendung durch (Name Spediteur o.ä.)
_____
Date of dispatch to BINDER GmbH / Tag der Absendung an BINDER GmbH:
_____

**We hereby declare that the following measures have been taken / Wir erklären, dass folgende Maßnahmen getroffen wurden:**

- Hazardous substances were removed from the unit including component parts, so that no hazard exists for any person in the handling or repair of these items / das Gerät/Bauteil wurde von Gefahrstoffen befreit, so dass bei Handhabung/Reparaturen für die betreffende Person keinerlei Gefährdung besteht
- The unit was securely packaged and properly identified / das Gerät wurde sicher verpackt und vollständig gekennzeichnet.
- Information about the hazardousness of the shipment (if required) has been provided to the transporter / der Spediteur wurde (falls vorgeschrieben) über die Gefährlichkeit der Sendung informiert.

We hereby commit ourselves and guarantee that we will indemnify BINDER GmbH for all damages that are a consequence of incomplete or incorrect information provided by us, and that we will exempt BINDER GmbH from eventual damage claims by third parties./ Wir versichern, dass wir gegenüber BINDER für jeden Schaden, der durch unvollständige und unrichtige Angaben entsteht, haften und BINDER gegen eventuell entstehende Schadenansprüche Dritter freistellen.

We are aware that, in accordance with Article 823 of the German Civil Code (BGB), we are directly liable with regard to third parties, in this instance especially the employees of BINDER GmbH, who have been entrusted with the handling / repair of the unit / component. / Es ist uns bekannt, dass wir gegenüber Dritten – hier insbesondere mit der Handhabung/Reparatur des Geräts/des Bauteils betraute Mitarbeiter der Firma BINDER - gemäß §823 BGB direkt haften

Name: \_\_\_\_\_

Position/Title: \_\_\_\_\_

Date / Datum: \_\_\_\_\_

Signature / Unterschrift: \_\_\_\_\_

Company stamp / Firmenstempel:



Equipment that is returned to the factory for repair must be accompanied by a completely filled out contamination clearance certificate. For service and maintenance on site, such a contamination clearance certificate must be submitted to the service technician before the start of any work. No repair or maintenance of the equipment is possible, without a properly filled out contamination clearance certificate.

## 23.2 For chambers in USA and Canada

### Product Return Authorization Request

Please complete this form and the Customer Decontamination Declaration (next 2 pages) and attach the required pictures. E-mail to: IDL\_SalesOrderProcessing\_USA@binder-world.com

After we have received and reviewed the complete information we will decide on the issue of a RMA number. Please be aware that size specifications, voltage specifications as well as performance specifications are available on the internet at [www.binder-world.us](http://www.binder-world.us) at any time.

Take notice of shipping laws and regulations.

	Please fill:	
Reason for return request	<input type="radio"/> Duplicate order	
	<input type="radio"/> Duplicate shipment	
	<input type="radio"/> Demo	<i>Page one completed by sales</i>
	<input type="radio"/> Power Plug / Voltage	115V / 230 V / 208 V / 240V
	<input type="radio"/> Size does not fit space	
	<input type="radio"/> Transport Damage	Shock watch tripped? ( <i>pictures</i> )
	<input type="radio"/> Other (specify below)	
	_____	
Is there a replacement PO?	<input type="radio"/> Yes <input type="radio"/> No	
<i>If yes -&gt; PO #</i>		
<i>If yes -&gt; Date PO placed</i>		
Purchase order number		
BINDER model number		
BINDER serial number		
Date unit was received		
Was the unit unboxed?	<input type="radio"/> Yes <input type="radio"/> No	
Was the unit plugged in?	<input type="radio"/> Yes <input type="radio"/> No	
Was the unit in operation?	<input type="radio"/> Yes <input type="radio"/> No	
<i>Pictures of unit attached?</i>	<input type="radio"/> Yes <input type="radio"/> No	Pictures have to be attached!
<i>Pictures of Packaging attached?</i>	<input type="radio"/> Yes <input type="radio"/> No	

	Customer Contact Information	Distributor Contact Information
Name		
Company		
Address		
Phone		
E-mail		

## Customer (End User) Decontamination Declaration

### Health and Hazard Safety declaration

To protect the health of our employees and the safety at the workplace, we require that this form is completed by the user for all products and parts that are returned to us. (Distributors or Service Organizations cannot sign this form)



NO RMA number will be issued without a completed form. Products or parts returned to our NY warehouse without a RMA number will be refused at the dock.

A second copy of the completed form must be attached to the outside of the shipping box.

<b>1.</b>	<b>Unit/ component part / type:</b>
<b>2.</b>	<b>Serial No.</b>
<b>3.</b>	<b>List any exposure to hazardous liquids, gasses or substances and radioactive material</b>
<b>3.1</b>	<b>List with MSDS sheets attached where available or needed (if there is not enough space available below, please attach a page):</b>
a)	_____
b)	_____
c)	_____
<b>3.2</b>	<b>Safety measures required for handling the list under 3.1</b>
a)	_____
b)	_____
c)	_____
<b>3.3</b>	<b>Measures to be taken in case of skin contact or release into the atmosphere:</b>
a)	_____
b)	_____
c)	_____
d)	_____
<b>3.4</b>	<b>Other important information that must be considered:</b>
a)	_____
b)	_____
c)	_____

**4. Declaration of Decontamination**

For toxic, radioactive, biologically and chemically harmful or hazardous substances, or any other hazardous materials.

We hereby guarantee that

4.1 Any hazardous substances, which have come into contact with the above-mentioned equipment / component part, have been completely listed under item 3.1 and that all information in this regard is complete.

4.2 That the unit /component part has not been in contact with radioactivity

4.3 Any Hazardous substances were removed from the unit / component part, so that no hazard exists for a persons in the shipping, handling or repair of these returned unit

4.4 The unit was securely packaged in the original undamaged packaging and properly identified on the outside of the packaging material with the unit designation, the RMA number and a copy of this declaration.

4.5 Shipping laws and regulations have not been violated.

**I hereby commit and guarantee that we will indemnify BINDER Inc. for all damages that are a consequence of incomplete or incorrect information provided by us, and that we will indemnify and hold harmless BINDER Inc. from eventual damage claims by third parties..**

Name: \_\_\_\_\_

Position: \_\_\_\_\_

Company: \_\_\_\_\_

Address: \_\_\_\_\_

Phone #: \_\_\_\_\_

Email: \_\_\_\_\_

Date: \_\_\_\_\_

Signature: \_\_\_\_\_



Equipment returned to the NY warehouse for repair must be accompanied by a completed customer decontamination declaration. For service and maintenance works on site, such a customer decontamination declaration must be submitted to the service technician before the start of work. No repair or maintenance of the equipment is possible without a completed form.