

# Heated Module



## Instructions For Use



 **This Manual Copyright © 2016 ITL** 

All rights reserved. No part of this manual may be reproduced, stored in a retrieval system, or transmitted, by any means or in any form, without the prior permission of Integrated Technologies Limited (ITL).

The information contained in this manual is subject to change without notice. ITL assumes no responsibility for any errors that may appear in this or related documentation.

Document: V501006  
Revision: 1-1604

**Vitl** is the brand name for Integrated Technologies' own range of laboratory products. For further information please visit our website:

[www.vitlproducts.com](http://www.vitlproducts.com)

All sales and technical enquiries should be addressed to:









**UK** Vitl Customer Services  
Integrated Technologies Limited  
Viking House, Ellingham Way, Ashford, Kent, TN23 6NF  
United Kingdom  
+44 (0)1233 638383  
[sales@vitlproducts.com](mailto:sales@vitlproducts.com)

**USA** ITL Virginia Inc  
305 Ashcake Road, Suite L, Ashland, Virginia 23005  
USA  
+1 804-381-0905  
[sales@vitlproducts.com](mailto:sales@vitlproducts.com)

**China** Integrated Electronic Systems (Shanghai) Co Ltd  
T3-11 Unit 201, No. 5001 Hua Dong Road, Pudong,  
Shanghai 201201, China  
+86 (0)21 585 854 63  
[sales@vitlproducts.com](mailto:sales@vitlproducts.com)

## 1 Symbols Used in this Instruction Manual

The following advisory symbols are used in this manual.

<b>Table 1: Advisory Symbol Meanings</b>	
 <b>DANGER</b>	Indicates a Risk of Electric Shock which could, if not avoided, result in severe injury or death.
 <b>DANGER</b>	Indicates a Burn Hazard which could, if not avoided, result in severe injury or death.
 <b>DANGER</b>	Indicates a Risk of Explosion which could, if not avoided, result in severe injury or death.
 <b>WARNING</b>	Indicates a hazardous situation which could, if not avoided, result in severe injury or death; or severely damage the unit.
 <b>CAUTION</b>	Indicates a hazardous situation which could, if not avoided, result in minor or moderate injury; or degrade or impair the functionality of the unit.
 <b>CAUTION</b>	Indicates an Electrostatic-Sensitive Device for which care should be taken not to touch the exposed electrical contacts as this could degrade or impair the functionality of the unit.
	Advisory note or other useful information.
 <b>NN</b>	Refer to “section NN” for more details.

## 2 Safety Precautions and Limitations of Use

It is essential that all users of this equipment have fully read and understood the following safety precautions and limitations of use before installing or operating the Heated Modules.

### IMPORTANT



**WARNING**

The protection provided by this equipment may be impaired if it is not used in a manner described in this manual.



**WARNING**

It is essential that the user of this equipment is aware of the potential hazards associated with the Module and its accessories.

All operators should be familiar with the safety precautions and warnings given in these instructions before attempting to operate the Module or base unit.

Improper use of this Module or its accessories may impair their functionality and invalidate the manufacturer's warranty.

### Unit Handling Precautions



**CAUTION**

Care should be taken not to drop the Module or subject it to rough physical handling, both during normal use and during transportation and storage.

Do not use the Module or base unit if either shows any signs of damage or wear.



**WARNING**

Care should be taken when handling the Heated Module as the external surfaces of the lid and underside of the Module may become hot during operation and remain hot for a considerable time after the heaters have been turned off.



**CAUTION**

Do not use excessive force when operating the heated lid catch or when opening and closing the lid.

## Unit Installation and Operating Environment



**DANGER**

The Heated Modules are designed for indoor laboratory use only.



**WARNING**

The acceptable operating room temperature range is 10°C to 38°C, with a relative humidity of 20% to 85% non-condensing, at a maximum altitude of 2000m above sea level.

If the Module is stored in conditions outside of these ranges, it must be left to stand unpowered until it has acclimatised to these environmental limits before being powered.



**DANGER**

Do not operate the Heated Module or base unit in any area which is, has been, or is thought to have been exposed to explosive or flammable gases, vapours or liquids.

## General Operating Precautions



**WARNING**

Ensure that the power is switched off on the base unit before attaching or removing the Heated Modules.



**DANGER**

The heaters can reach temperatures of up to 105°C and will remain hot for a considerable time after being turned off.

Extreme care must be taken not to touch the heated surfaces as they may cause a severe burn injury.



**DANGER**

The Heated Modules are intended for use with aqueous solutions and suspensions only.

Never use the module with any explosive, volatile or highly reactive substances or chemicals.



**WARNING**

To avoid liquid spills, sample evaporation and possible cross-contamination of samples, only use sealed plates and closed tubes.

Always use Heated Modules with the consumables specified for them and always use suitable consumables for the desired temperature range.

**CAUTION**

Do not touch the exposed electrical contacts of the Heated Module or base-unit as an Electrostatic Discharge (ESD) could degrade or impair their functionality.

**CAUTION**

For optimum performance and to prevent dirt build-up or ingress, always keep the heated lid closed when not accessing the sample plate or tubes.

**WARNING**

Always follow prescribed laboratory procedures and use appropriate personal protective equipment (PPE, such as gloves, clothing, goggles, etc.) when handling samples.

## Unit Maintenance and Serviceability

**DANGER**

There are no user or operator serviceable parts inside the Heated Modules or base unit.

Do not remove any casework.

**WARNING**

Removal of the casework will void the manufacturer's warranty and may expose the user to a risk of electric shock resulting in serious injury or death.

**DANGER**

Always switch off the base unit and disconnect the power cord before performing any cleaning or decontamination procedure.

If liquid is spilt into or over the module or unit, switch off and disconnect the power from the AC mains outlet before attempting to deal with the spillage.

**CAUTION**

Ensure that all heated surfaces have cooled down to room temperature before performing any cleaning operation and before moving or storing the unit.

**CAUTION**

The use of harsh chemicals and cleaning agents may damage the Heated Module and base unit and degrade their performance.

Always follow the cleaning and decontamination procedures specified in sections 7.1 and 7.2 of this instruction manual.

### 3 Regulatory Limitations of Use

#### Declaration of Conformity



ELECTRICAL SAFETY  
E113628

Integrated Technologies Limited (ITL) affirm that this product fulfils the essential requirements of the Low Voltage Directive (LVD) 2006/95/EC and the EMC Directive 2004/108/EC, when installed and operated in accordance with the instructions given in this manual.

The Heated Modules have been type tested in conjunction with the Flexi-therm base-unit by TRaC Global Ltd (UKAS accredited Testing Laboratory No 0026) against the Safety and EMC Requirements listed below, and issued Certificate Nos GB-TRAC 0684 and TRA-025949-38.

#### Safety and EMC Requirements

##### SAFETY

- EN 61010-1:2010, EN 61010-2-010:2003
- UL 61010-1:2001 2nd Edition (CAN C22.2 CSA 61010-1)

##### EMC

- EN 61326:2006, Class B
- FCC CFR 47 Parts 15.107 and 15.109, Class B

#### RoHS and WEEE Directive Compliance



This product complies with the requirements of the RoHS2 Directive 2011/65/EU for Electrical and Electronic Equipment.

Where applicable, the Heated Module should be disposed of in accordance with the European Union WEEE Directive 2002/96/EC on Waste Electrical and Electronic Equipment.

Do not dispose of this product into unsorted municipal waste or public landfill. Please refer to section 7.4 for details of how to correctly dispose of this product.

The Heated Modules are designed and manufactured under ISO 9001 by:

#### Integrated Technologies Limited

Viking House, Ellingham Way, Ashford, Kent, TN23 6NF  
United Kingdom



## 4 Module Description

The Heated Modules are interchangeable self-contained precision-calibrated sample block heaters specifically designed for particular sample plate or tube types. Most Modules also have an integral sprung heated lid to prevent condensation from forming on the lids of the sample vessels.

A typical Heated Module has the following features:

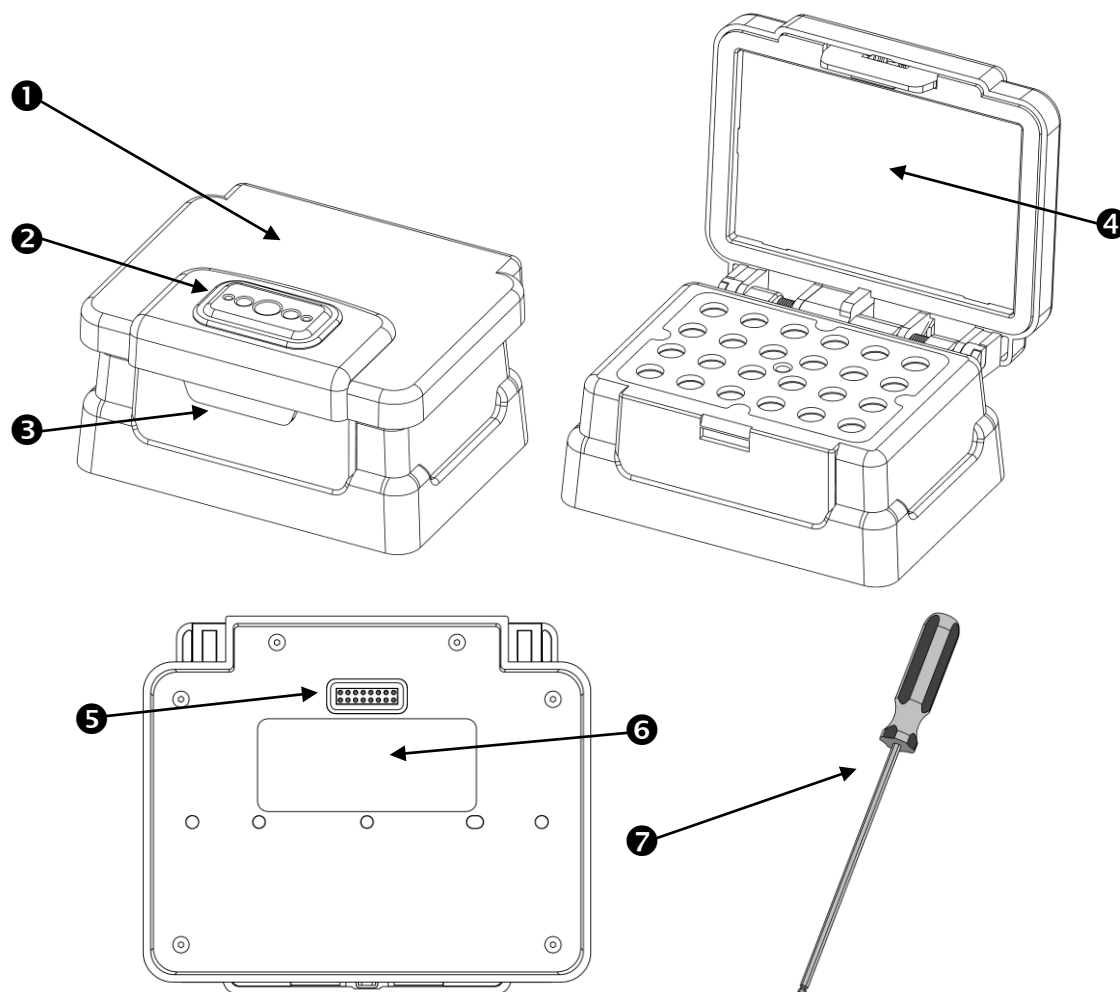

**Table 2: Module Features**

<b>1</b>	Lid	
<b>2</b>	Lid Catch Button	
<b>3</b>	Lid Catch	
<b>4</b>	Sprung Anti-Condensation Lid Heater	
<b>5</b>	Heated Module Interface Port (underside)	⇒ 5
<b>6</b>	Product Information Label (underside)	⇒ <i>below</i>
<b>7</b>	3mm Hex-Driver Module Securing Tool	⇒ 5

The product information label is located on the underside of the Module and provides the Module type (REF) and serial number (SN):

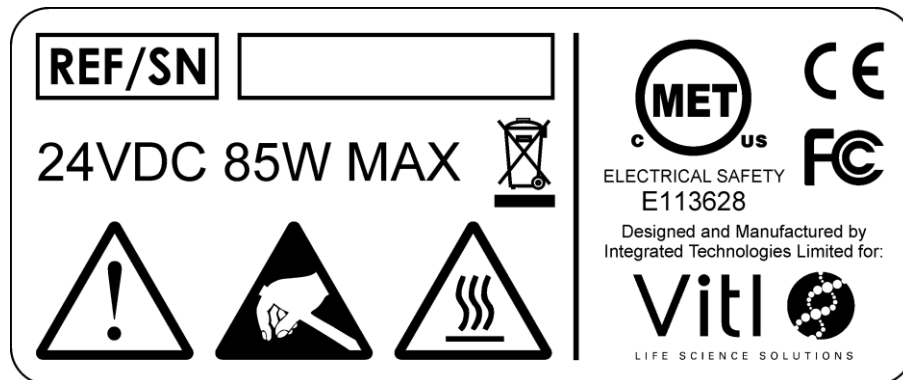

The current available range of Heated Modules is listed in Table 3. Refer to section 6 for their full Technical Specifications.

Please note that the range of Modules is constantly expanding and will eventually include Modules for various PCR and micro plates, 0.2mL, 15mL and 50mL tubes.

**Table 3: Heated Module Selection Guide**

Sample Tube or Plate Type	Module Type
0.5mL Conical Tube	HM01
1.5mL Conical Tube	HM02
2.0mL Round Tube	HM03

Other bespoke Heated Modules and optional accessories may be available on request. Please contact your distributor for details.



## 5 Module Installation

Before installing the Heated Module, please check that the delivery is complete and that the unit and any accessory parts are intact and free from any signs of transportation damage. Also ensure that all external and internal packaging has been removed from the unit before installation.



Please retain all packaging for future transportation and storage of the unit and its accessories.

The Heated Module is designed for use with the following Vitl base units:

-  - Dry Block Heater
-  - Heated Laboratory Mixer



**WARNING**

Please also observe and abide by the **Unit Installation and Operating Environment** safety precautions and preconditions listed in section 2.

Install the Heated Module using the following procedure:

- 1) Switch off the power to the base unit.
- 2) Place the Heated Module on the docking platform of the base unit, ensuring that it engages with the two location dowels and sits flat on the platform. Do not use excess force – it should be a comfortable fit.
- 3) Open the Module lid (if fitted) and, using the 3mm hex-driver supplied with the base unit, screw the module to the base unit using either the central fixing screw or the two side screws.

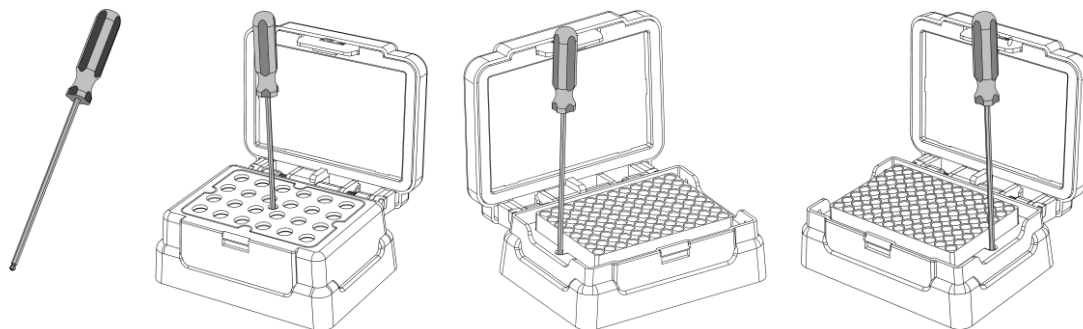

- 4) Ensure that the Module is firmly secured, but do not over tighten the screw(s) as it may damage them and make it hard to remove the Module later.
- 5) Close the module lid (if fitted) and switch on the power to the base unit.

**DANGER**

If the Module has been stored in a cool environment, it must be left to stand unplugged until it has acclimatised to the new room temperature before being powered.

## 6 Technical Specifications

This section details the generic and individual technical specifications for the range of Heated Modules listed in Table 3.

**Table 4: Heated Module Generic Specifications**

<b>Power Supply</b>	
Supply Voltage Range	24 VDC $\pm$ 5%
Power Consumption	85 W max
<b>Operating Environment</b>	
Room Temperature Range	+10 to +38 °C
Relative Humidity Range	20% to 85% non-condensing
Maximum Operating Altitude	2000 m above sea-level
<b>Storage and Transportation</b>	
Temperature Range	-10 to +50 °C
Relative Humidity Range	20% to 95% non-condensing
<b>Physical Properties (HM01-03)</b>	
Maximum Dimensions (W x D x H)	150 mm x 124 mm x 85 mm
Maximum Weight (Unloaded)	1.2 kg

**Table 5: HM01 Detailed Specification**

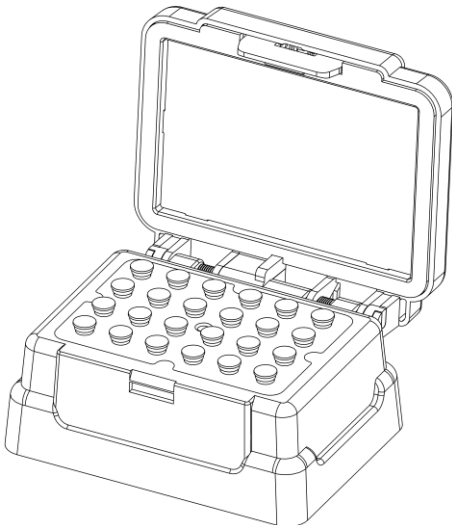
<b>Catalogue Number</b> V104001	
<b>Module Type</b> HM01	
<b>Sample Vessel Type</b> 24 x 0.5mL Conical Tubes	
<b>Block Borehole Dimensions</b> Ø L x W (mm): 8 Depth (mm): 25.4 Bottom Shape: Conical	
<b>Block Temperature Range</b> Ambient +5°C to 99.9°C	
<b>Lid Temperature Range</b> Block +4°C to 105°C	
<b>Maximum Mix Speed</b> 2000 RPM	

**Table 6: HM02 Detailed Specification**

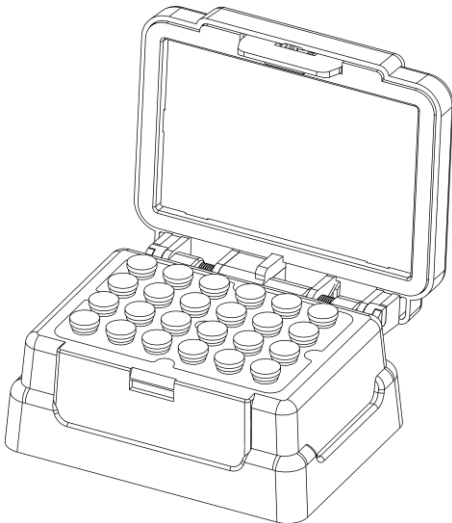

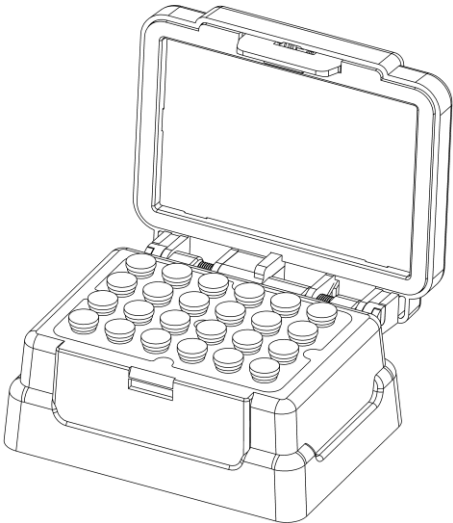

<b>Catalogue Number</b> V104002	
<b>Module Type</b> HM02	
<b>Sample Vessel Type</b> 24 x 1.5mL Conical Tubes	
<b>Block Borehole Dimensions</b> Ø L x W (mm): 11 Depth (mm): 35.5 Bottom Shape: Conical	
<b>Block Temperature Range</b> Ambient +5°C to 99.9°C	
<b>Lid Temperature Range</b> Block +4°C to 105°C	
<b>Maximum Mix Speed</b> 2000 RPM	

**Table 7: HM03 Detailed Specification**

<b>Catalogue Number</b> V104003	
<b>Module Type</b> HM03	
<b>Sample Vessel Type</b> 24 x 2.0mL Round Tubes	
<b>Block Borehole Dimensions</b> Ø L x W (mm): 11 Depth (mm): 36.5 Bottom Shape: Round	
<b>Block Temperature Range</b> Ambient +5°C to 99.9°C	
<b>Lid Temperature Range</b> Block +4°C to 105°C	
<b>Maximum Mix Speed</b> 2000 RPM	

## 7 Maintenance and Servicing

Although the Heated Module does not require any scheduled maintenance or servicing, the operator should regularly clean and inspect the module for any defects, as described in section 7.1 below.

 <b>DANGER</b>	Please observe and comply with all of the <b>Unit Maintenance and Serviceability</b> precautions listed in section 2.
 <b>WARNING</b>	Never remove the unit casework. There are no user or operator serviceable parts inside the unit.
 <b>CAUTION</b>	Always switch off and unplug the unit before performing any cleaning or disinfecting tasks.
 <b>CAUTION</b>	Ensure that all heated surfaces have cooled down to room temperature before performing any cleaning or inspection operations on the base unit or Heated Module.
	Practice anti-static precautions by avoiding direct touching of the exposed electrical contacts or using statically charged cleaning cloths.

For technical and service related enquiries, please contact your distributor or Vitl at the address given on page 2 of this manual.

### 7.1 Routine Cleaning and Inspection

The unit casework should be cleaned and inspected at regular intervals and whenever contamination or spillage occurs, as follows:

1. Switch off the base unit and disconnect the power before performing any inspection checks or cleaning.
2. Before cleaning, always inspect the unit casework and Heated Module for any signs of wear, damage, cracks or other defects.
3. Use a dry linen cloth or cotton bud to remove any dirt build-up on or around the electrical contacts of the Heated Module interface port. Do not wet these contacts as this will cause corrosion and malfunction.

4. Wearing suitable PPE, clean the casework using a damp cloth soaked with a disinfectant solution (such as Virkon).



**DANGER**

After cleaning, ensure that the unit and Heated Module are thoroughly dry, especially around the mains power inlet, before reconnecting the power cord and switching the unit on.



## 7.2 Decontamination Procedure

The Heated Module and its accessories should be decontaminated using the following procedure before being stored or transported.

### Certificate of Decontamination

We respect the health and safety of our customers and employees, and request that any products or accessories being returned are decontaminated in accordance with the procedure below.

#### 1. Decontamination Procedure

Thoroughly clean all outside surfaces of the product (including any accessories, power cords, manuals, packaging, etc.) with a damp cloth soaked with suitable disinfectant solution (such as Virkon).

Allow to dry fully before packing.

#### 2. Decontamination Declaration

Company Name: \_\_\_\_\_

Address: \_\_\_\_\_

Product Description: \_\_\_\_\_

Serial Number: \_\_\_\_\_

Reason For Return: \_\_\_\_\_

Where Product Used: \_\_\_\_\_

Please tick the appropriate option(s) below:

- I certify that I have decontaminated the product as per the above procedure.  
Decontaminant Used: \_\_\_\_\_
- I certify that the product has not been exposed to any chemical or biological materials.

Title: _____	Name: _____
Signature: _____	Date: _____
Telephone: _____	Email: _____

### 7.3 Transportation and Storage

The Heated Module and its accessories should be thoroughly decontaminated using the procedure detailed in section 7.2 before being placed in its original packaging for transportation or storage.



**WARNING**

Refer to section 6 for the acceptable range of Storage and Transportation environmental conditions.

Always ensure that the unit and accessories are completely dry and free of any condensation before being packed.

### 7.4 Product Disposal

At end-of-life, this product must be disposed of in accordance with your local authority regulations for the disposal of potentially hazardous waste and electronic equipment.

The unit and its accessories should be decontaminated using the procedure detailed in section 7.2 before disposal or shipping.



Do not dispose of this product into unsorted municipal waste or public landfill.

Please contact your distributor (or Vitl at the address on page 2 of this manual) for details of how to correctly dispose of this product.

## 8 Warranty and Returns

Integrated Technologies Limited (ITL) warrants the Heated Modules, when purchased new and installed and operated in accordance with the instructions of this manual, to be free from defects in materials and workmanship, and will repair or replace, at their discretion, any module or accessory which exhibits such defects.

In no event will ITL be liable for any indirect, incidental or consequential damages resulting from any defect or warranty claim.

**NOTE**

Unspecified use or unauthorised modification of any part of the Heated Modules or its accessories or the use or attachment of any adaptor or peripheral not supplied, specified or sanctioned by ITL will invalidate this warranty.

This warranty is provided to the original purchaser of the product for one year from the date of purchase.

Under the terms of this warranty, the product must be returned in its original packaging, transportation prepaid by the sender, with a copy of the Proof of Purchase and a detailed description of the problem.

**WARNING**

The product must be decontaminated using the procedure detailed in section 7.2 and a Certificate of Decontamination supplied with any return. If the product is considered too hazardous to be shipped, please contact ITL on the number given on page 2 of this manual for further instructions.













Please contact your distributor (or ITL on the number given on page 2 of this manual) to receive authorisation to return the product.

## 9 Glossary of Terms and Abbreviations

<b>ANSI</b>	American National Standards Institute
<b>EMC</b>	Electro-Magnetic Compatibility
<b>Microtiter Plate</b>	Plate with an SBS footprint featuring 24, 48, 96 or 384 wells
<b>MTP</b>	Microtiter plate
<b>PCR</b>	Polymerase Chain Reaction
<b>PPE</b>	Personal Protective Equipment
<b>SBS</b>	Society for Bio molecular Screening
<b>Semi-skirted PCR Plate</b>	PCR plate with an outer surrounding half edge
<b>Skirted PCR Plate</b>	PCR plate with an outer surrounding edge
<b>Un-skirted PCR Plate</b>	PCR plate without an outer surrounding edge
<b>Well</b>	A single sample cavity in a Microtiter or PCR plate

---

## Index

1	 Symbols Used in this Instruction Manual .....	3
2	 Safety Precautions and Limitations of Use.....	4
3	 Regulatory Limitations of Use .....	8
4	 Module Description.....	9
5	 Module Installation .....	11
6	 Technical Specifications.....	12
7	 Maintenance and Servicing .....	15
7.1	 Routine Cleaning and Inspection .....	15
7.2	 Decontamination Procedure.....	17
7.3	 Transportation and Storage.....	18
7.4	 Product Disposal .....	18
8	 Warranty and Returns .....	19
9	 Glossary of Terms and Abbreviations .....	20

## Tables

Table 1: Advisory Symbol Meanings.....	3
Table 2: Module Features .....	9
Table 3: Heated Module Selection Guide .....	10
Table 4: Heated Module Generic Specifications.....	12
Table 5: HM01 Detailed Specification.....	13
Table 6: HM02 Detailed Specification.....	13
Table 7: HM03 Detailed Specification.....	14

 **Notes** 