

FLY INCUBATORS 100 - 120 Voltage



# Installation and Operation Manual

SRI6PF, SRI20PF  
Previously Designated  
LI6P-FLY, LI20P-FLY

# Sheldon Refrigerated Incubator Peltier FLY

## 100 - 120 Voltage

### Installation and Operation Manual

**Part Number (Manual): 4861674-1**

**Revision: October 9, 2015**

Pictured on Cover: SRI6PF Left, SRI20PF Right

These units are TÜV CUE listed as incubators and radiant warmers for professional, industrial, or educational use where the preparation or testing of materials is done at an ambient air pressure range of 22.14 – 31.3 inHg (75 – 106 kPa) and no flammable, volatile, or combustible materials are being heated.

These units have been tested to the following requirements:

CAN/CSA C22.2 No. 61010-1:2012

CAN/CSA C22.2 No. 61010-2-010:2004 Reaffirmed: 2014-07

UL 61010-1:2012-05

UL 61010A-2-010:2002-03

EN 61010-1:2010

EN 61010-2-010:2014

Supplemented by: UL 61010-2-010:2015

This page left blank

# TABLE OF CONTENTS

<b>INTRODUCTION</b> .....	<b>6</b>
<i>General Safety Considerations</i> .....	6
<i>Engineering Improvements</i> .....	7
<i>Contacting Assistance</i> .....	7
<b>RECEIVING YOUR INCUBATOR</b> .....	<b>8</b>
<i>Inspect the Shipment</i> .....	8
<i>Orientation Photos</i> .....	9
<i>Recording Data Plate Information</i> .....	11
<i>Reference Sensor Device</i> .....	11
<b>INSTALLATION</b> .....	<b>12</b>
<i>Location</i> .....	12
<i>Power Source Requirements</i> .....	12
<i>Lifting and Handling</i> .....	13
<i>Leveling</i> .....	13
<i>Access Port Stopper</i> .....	13
<i>Install Incubator in Location</i> .....	13
<i>Deionized and Distilled Water</i> .....	13
<i>Installation Cleaning and Disinfection</i> .....	14
<i>Install Side Air Ducts SRI20PF</i> .....	14
<i>Shelving Installation</i> .....	15
<b>GRAPHIC SYMBOLS</b> .....	<b>17</b>
<b>CONTROL PANEL OVERVIEW</b> .....	<b>18</b>
<b>OPERATION</b> .....	<b>20</b>
<i>Theory of Operation</i> .....	20
<i>Preparing the Incubator</i> .....	22
<i>Set Current and Cycle Start Times</i> .....	23
<i>Turn Off the OTL</i> .....	25
<i>Set the Nighttime Temperature Set Point</i> .....	26
<i>Set the Daytime Temperature Set Point</i> .....	27
<i>Temperature Display Accuracy Verification</i> .....	28
<i>Set the Over Temperature Limit</i> .....	30
<i>Loading the Incubator</i> .....	32
<i>Attaching equipment to the Interior Accessory Outlet</i> .....	32
<i>Humidifying the Incubator</i> .....	32
<i>Managing Condensation</i> .....	33
<i>Launching the Auto Cycle</i> .....	34
<i>Ending the Auto Cycle</i> .....	34
<i>Turn Alarm Off / On</i> .....	36
<b>USER MAINTENANCE</b> .....	<b>38</b>
<i>Cleaning and Disinfecting</i> .....	38
<i>Maintaining Atmospheric Integrity</i> .....	39
<i>Electrical Components</i> .....	39
<i>Calibrate the Temperature Display</i> .....	40
<b>UNIT SPECIFICATIONS</b> .....	<b>47</b>
<i>Weight</i> .....	47
<i>Dimensions</i> .....	47
<i>Capacity</i> .....	47
<i>Shelf Capacity by Weight</i> .....	48
<i>Temperature</i> .....	48

*Power* ..... 48  
**PARTS LIST** ..... 49

# INTRODUCTION

*Thank you for purchasing a Sheldon Refrigerated Peltier Fly Incubator. We know that in today's competitive marketplace, customers have many choices when it comes to constant temperature equipment. We appreciate you choosing ours. Our continued reputation as a leading laboratory product manufacturer rests with your satisfaction. Sheldon Manufacturing, Inc. stands behind our products, and we will be here if you need us.*

These incubators are intended for professional, industrial, or educational use for fruit fly cultivation. These units are not designed for use in hazardous or household locations.

Before using the incubator read this entire manual carefully to understand how to install, operate, and maintain the unit in a safe manner. Keep this manual available for use by all unit operators. Ensure that all operators are given appropriate training prior to using the incubator.

---

**Note:** This unit is designed for the growth, cultivation, incubation, and storage of fruit flies (*Drosophila melanogaster*). Improper use of this unit will void the manufacturing defect warranty. Other units are specifically manufactured for BOD applications. Consult your Shel Lab dealer or customer service representative in order to identify another model suitable for your application.

---

## GENERAL SAFETY CONSIDERATIONS

---

**Note:** Failure to follow the guidelines and instructions in this manual may create a protection impairment by disabling or interfering with the unit safety features. This can result in injury or death.

---

Your incubator and its recommended accessories are designed and tested to meet strict safety requirements. Only use this equipment for its intended application. Any alterations or modifications void the warranty.

For continued safe operation of your incubator always follow basic safety precautions including:

- Always plug the unit power cord into a protective earth grounded electrical receptacle (outlet) that conforms to national and local electrical codes. If the unit is not grounded properly, parts such as knobs and controls can conduct electricity and cause serious injury.
- Avoid damaging the power cord. Do not bend it excessively, step on it, or place heavy objects on it. A damaged cord can be a shock or fire hazard. Never use a power cord if it is damaged.
- Always position the unit so that end-users can quickly unplug it in the event of an emergency.
- Do not attempt to move the unit while in operation or before the unit has cooled.
- Use only approved accessories. Do not modify system components. Any alterations or modifications to your unit can be dangerous and void your warranty.
- Follow all local ordinances in your area regarding the use of this unit. If you have any questions about local requirements, please contact the appropriate agencies.

# INTRODUCTION (CONTINUED)

## *ENGINEERING IMPROVEMENTS*

Sheldon Manufacturing continually improves all of its products. As a result, engineering changes and improvements are made from time to time. Therefore, some changes, modifications, and improvements may not be covered in this manual. If your unit's operating characteristics or appearance differs from those described in this manual, please contact your Shel Lab dealer or distributor for assistance.

## *CONTACTING ASSISTANCE*

If you are unable to resolve a technical issue with your incubator, please contact Sheldon Technical Support. Phone hours for Sheldon Technical Support are 6 am – 4:30 pm Pacific Coast Time (west coast of the United States, UTC -8). Please have the following information ready when calling or emailing Technical Support: the **model number** and the **serial number** (see page 11).

EMAIL: tech@shellab.com PHONE: 1-800-322-4897 extension 4, or (503) 640-3000 FAX: (503) 640-1366

Sheldon Manufacturing INC.  
P.O. Box 627  
Cornelius, OR 97113

# RECEIVING YOUR INCUBATOR

Before leaving the factory, all incubators are packaged in high-quality shipping materials to provide protection from transportation-related damage. When a unit leaves the factory, safe delivery becomes the responsibility of the carrier. Damage sustained during transit is not covered by the warranty.

This makes it important that you inspect your incubator for concealed loss or damage to its interior and exterior when receiving it. If you find any damage to the unit, follow the carrier's procedure for claiming damage or loss.

The orientation photos found on the following pages may serve as a useful visual guide for inspections.

## INSPECT THE SHIPMENT

Carefully inspect the shipping carton for damage. Report any damage to the carrier service that delivered the incubator. If the carton is not damaged, open the carton and remove the contents. The unit should come with an Installation and Operation Manual, warranty card, and a Certificate of Compliance.

Verify that the correct number of the following accessories are present:

Model	Shelves	Shelf Mounts	Shelf Mounts
SRI6PF	2	4 Standard Brackets	--
SRI20PF	5	8 Standard Brackets	2 Sliding Brackets



6800525



5220942



9490560

Model	Leveling Feet	Access Port Stopper*	Side Air Duct Panels
SRI6PF	4	1	0
SRI20PF	4	1	2



2700506



7750517



\*The stopper ships installed in the access port, inside the unit incubation chamber.

The unit also comes with an 115V, 15 Amp, 8 feet (2.5m), NEMA 5-15P power supply cord.

Carefully check all packaging before discarding. Save the shipping carton until you are sure everything works properly.



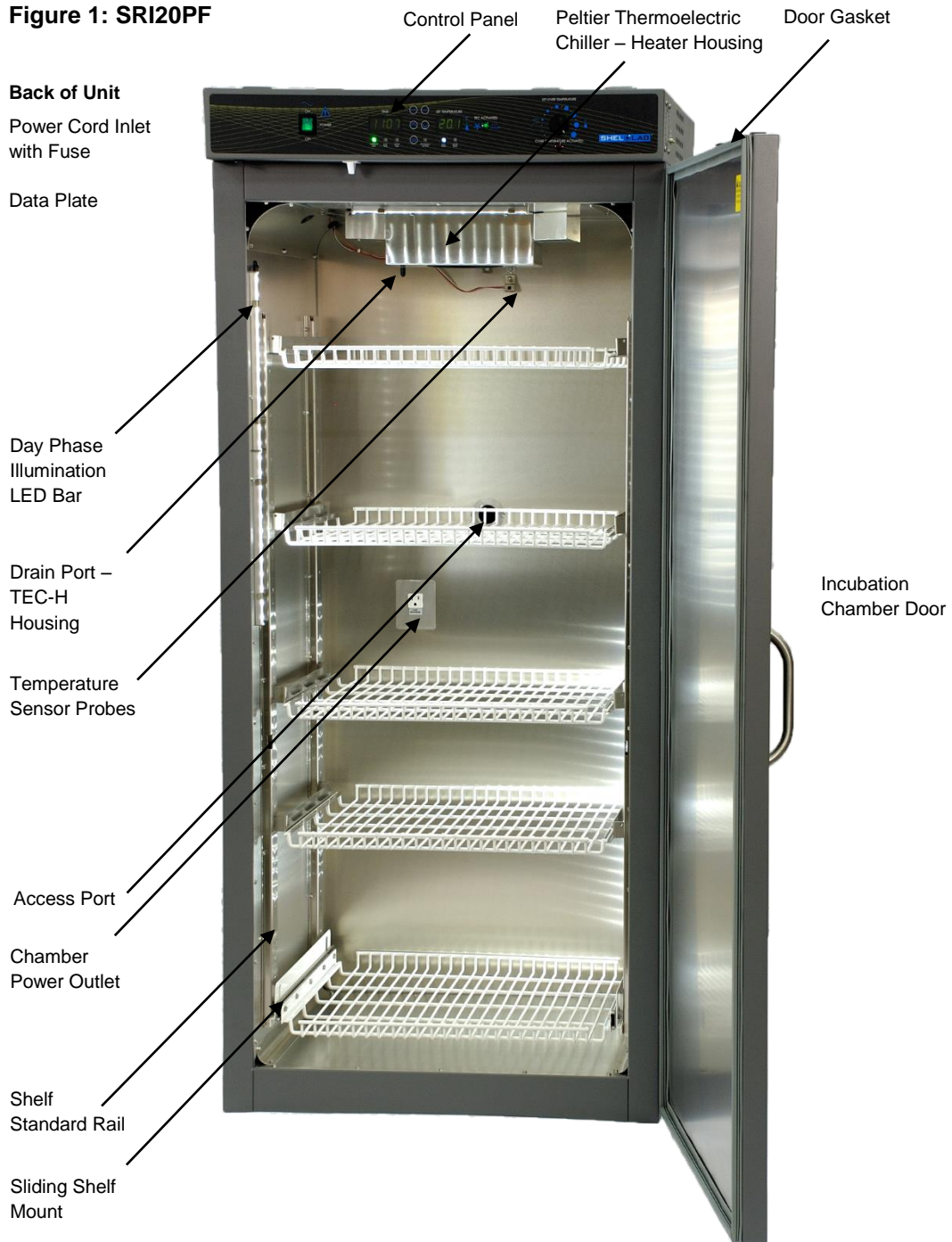
1800510



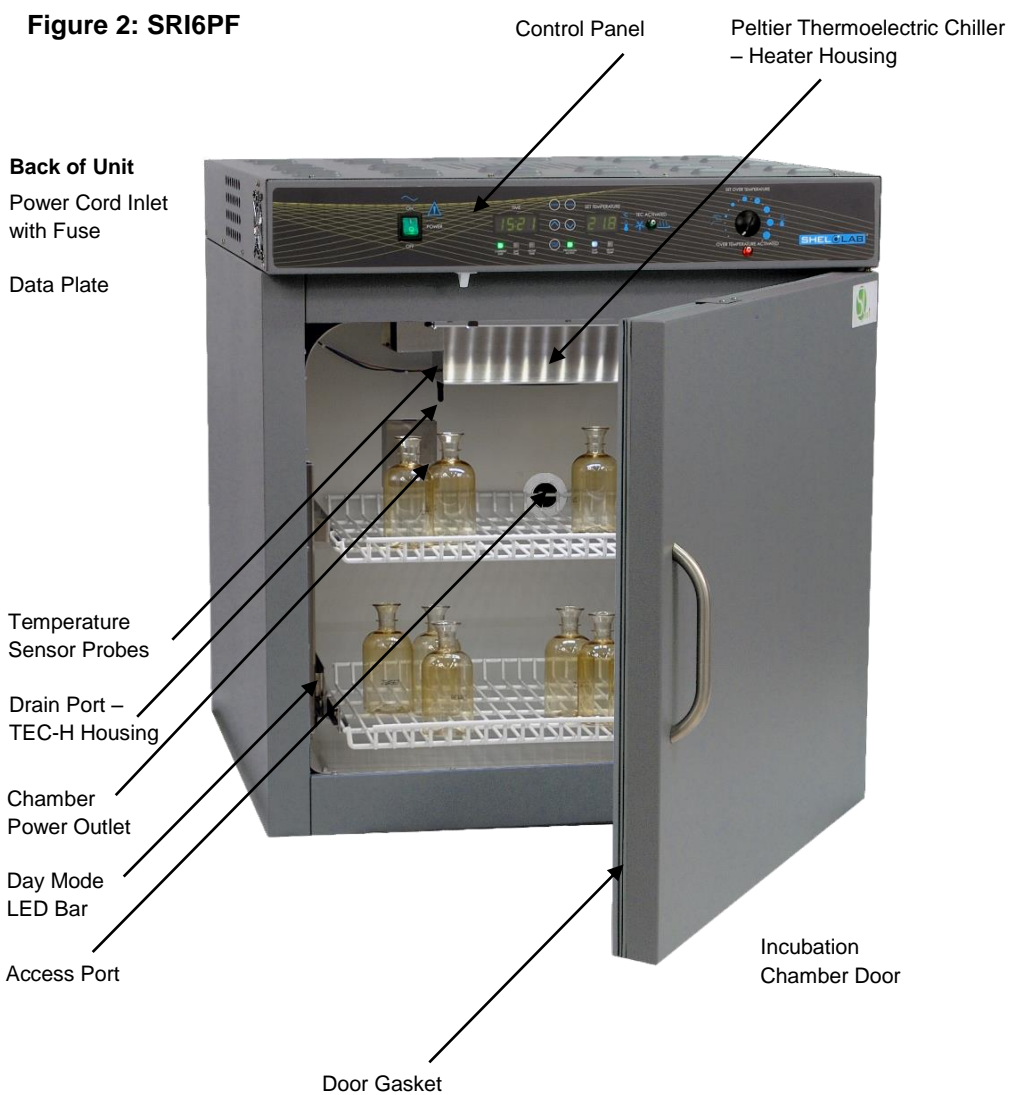
# RECEIVING YOUR INCUBATOR (CONTINUED)

## ORIENTATION PHOTOS

**Figure 1: SRI20PF**



# RECEIVING YOUR INCUBATOR (CONTINUED)



# RECEIVING (CONTINUED)

## RECORDING DATA PLATE INFORMATION

The data plate contains the incubator **model number** and **serial number**. Record this information for future reference.

The data plate is located on the back of the unit, on the top right side.

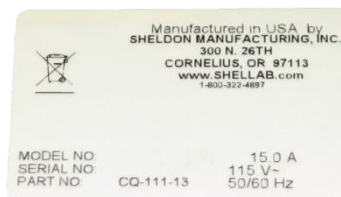


Figure 3: Data Plate

## Date Plate Information

Model Number	
Serial Number	

## REFERENCE SENSOR DEVICE

A reference device must be purchased separately for performing temperature display accuracy verifications and calibrations.

The reference device must be accurate to at least 0.1°C. The device should be regularly calibrated, preferably by a third party. For best results, use a digital device with a wired-connected temperature sensing probe that can be placed in the incubation chamber through the access port, or through the chamber door space, with the door closed over the probe wire. For example, a wire thermocouple probe.

Reference readings that avoid chamber door openings eliminate significant wait periods required for the chamber temperature to re-stabilize each time the chamber is disturbed.

Alcohol thermometers do not have sufficient accuracy for conducting accurate temperature verifications and calibrations. Do not use a mercury thermometer. **Never place a mercury thermometer in the incubation chamber.**

# INSTALLATION

This incubator is intended for use indoors, at room temperatures between **15°C and 30°C (59°F and 86°F)**, at no greater than **80% Relative Humidity** at 25°C (77°F). Allow a minimum of **4 inches (10cm)** between the incubator and walls or partitions and **2 inches (5cm)** of clearance above the top of the incubator for unobstructed airflow. Position the unit so the end-user has access to the power plug.

Operating the unit outside these conditions may adversely affect its temperature range and stability. For conditions outside of those listed above, please contact your distributor to explore other unit options suited to your laboratory or production environment.

## LOCATION

When selecting a location to install the incubator, consider all environmental conditions that can affect the effective temperature range, uniformity, and stability of the unit. For example:

- Ovens, autoclaves, and any device that produces significant radiant heat
- Heating and cooling ducts, or other sources of fast moving air currents
- High-traffic areas
- Direct sunlight

## POWER SOURCE REQUIREMENTS

When selecting a location for the unit, verify that each of the following requirements are satisfied:

- Wall power sources must match the voltage and ampere requirements listed on the unit data plate. These units are intended for 100 – 120 VAC 50/60 Hz applications at the following amperages: SRI20PF **5.5 Amps**; SRI6PF **4.0 Amps**.
- **Supplied voltage must not vary more than 10% from the data plate rating.** Damage to the unit may result if supplied voltage varies more than 10%.
- The wall power source must conform to all national and local electrical codes.
- Wall power sources must be protective earth grounded. Use a separate circuit to prevent loss of product due to overloading or circuit failure.
- Each SRIPF is provided with a 250V, T6.3A, 5X20MM fuse located in the power cord inlet on the back of the incubator.
- The unit must be positioned so that all end-users can quickly unplug the power cord in the event of an emergency.
- The unit comes provided with a 125 volt, 15Amp, 9ft 5 in (2.86m) NEMA 5-15P power cord.



# INSTALLATION (CONTINUED)

## LIFTING AND HANDLING

An SRIPF Incubator should only be lifted by its bottom surfaces using proper heavy lifting machinery such as a forklift or pallet jack. Handles and knobs are inadequate for lifting or stabilization. The unit should be completely restrained from tipping during lifting. Transporting the unit while lifted is not recommended and may be hazardous. Remove all moving parts, such as shelves and trays, and secure the door in the closed position prior to lifting the unit.

Do not attempt to move the unit while in operation or before the unit has cooled.

## LEVELING

The unit must be level and stable for safe operation. Each incubator ships with four leveling feet. Insert one leveling foot into each of the four holes in the bottom corners of the unit. Adjust the foot at each corner until the unit stands level and solid without rocking. To raise a foot, turn it in a counterclockwise direction; to lower a foot, turn it in a clockwise direction.

To prevent damage to the feet while in transport, turn all the feet to the maximum counterclockwise position prior to transport.

## ACCESS PORT STOPPER

Each SRIPF incubator is provided with an access port located on the back wall of the incubation chamber. The incubator is shipped with one rubber access port stopper installed in the port, inside the chamber. The stopper should always be installed inside the chamber to obtain the best temperature uniformity and prevent condensation from forming inside the port. A second stopper may be installed on the outside of the unit to prevent dust from building up in the port, but is not required.

Wires for thermocouples and other sensor probes may be introduced into the chamber through the access port. The stopper may be put in place over the wires.

The port stopper must be in place during operation in order for the incubation chamber to achieve its specified temperature stability and uniformity levels.

## INSTALL INCUBATOR IN LOCATION

Install the unit in a workspace location that meets the criteria discussed in the previous entries of the Installation section.

## DEIONIZED AND DISTILLED WATER

**Do not use deionized water** to clean the incubator. Use of deionized water may corrode metal surfaces and voids the warranty. Sheldon Manufacturing recommends the use of distilled water in the resistance range of 50K Ohm/cm to 1M Ohm/cm, or a conductivity range of 20.0 uS/cm to 1.0 uS/cm, for cleaning applications.



Figure 4: Leveling Foot and Port Stopper



# INSTALLATION (CONTINUED)

## *INSTALLATION CLEANING AND DISINFECTION*

If required by your laboratory protocol, clean and manually disinfect the incubator chamber and shelving components. Cleaning and disinfecting during installation reduces the risk of contamination. The chamber and shelving were cleaned at the factory, however, Sheldon Manufacturing cannot guarantee that the incubator was not exposed to contaminants during shipping.

Remove all wrappings and coverings from shelving (and the air ducts of the SRI20P-2) prior to cleaning and installation.

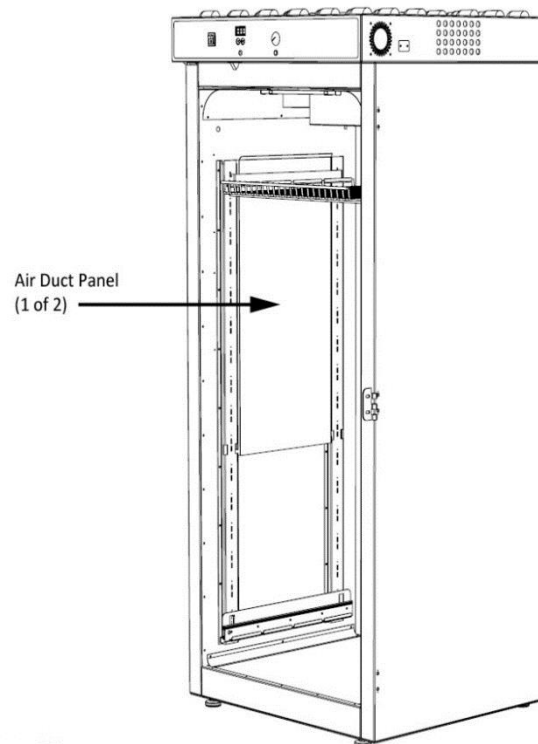
Please see the [Cleaning and Disinfecting](#) entry on page 38 in the User Maintenance section for information on how to clean and disinfect without damaging the incubator or its components. A decontamination cycle will be run as part of the Incubator set up in the Operation section.

## *INSTALL SIDE AIR DUCTS SRI20PF*

Two (2) side air duct panels are included in the SRI20PF accessories. Hang the panels on the chamber side walls, by placing the hooks on the top and bottom corners of the panels into the slots provided on the shelf standard mounting rails. The SRI6PF incubator does not require side ducts.

**Figure 5: SRI20PF**

**Air Duct Panel**



---

**Note:** The air duct panels play an important role maintaining even heat distribution inside the long incubation chamber of the SRI20PF. Failure to install both air duct panels may adversely impact the incubator's temperature uniformity.

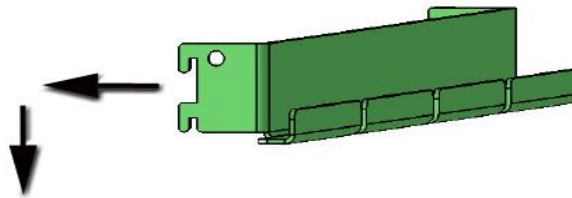
---

# INSTALLATION (CONTINUED)

## *SHELVING INSTALLATION*

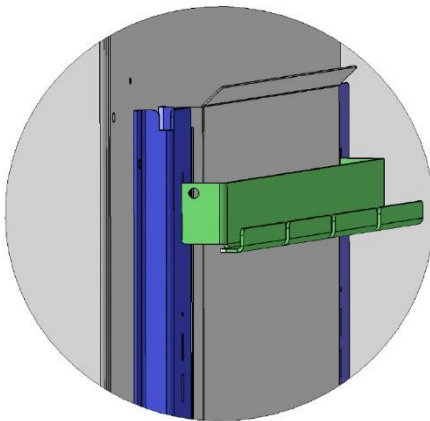
### **SRI6PF and SRI20PF Standard Shelving Installation**

Perform the following steps to install the SRI6PF and SRI20PF incubator standard shelves:

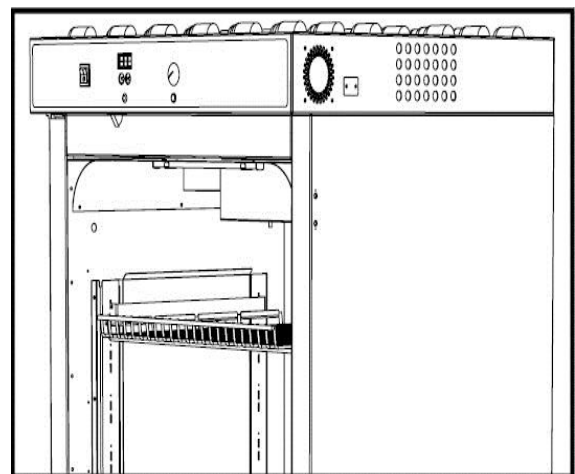


**Figure 6: Standard Shelf Mounting Bracket Installation**

1. Insert the 2 pairs of tabs on the bracket (front and back) into the slots on the shelf standard rails of the incubation chamber.
2. Slide the bracket down so that the tabs are securely seated in the mounting slots.
3. Repeat the process on the opposite side of the chamber with the second mounting bracket.
4. Install 1 shelf on the 2 mounting brackets.



**Figure 7: Standard Mounting Bracket Installed**

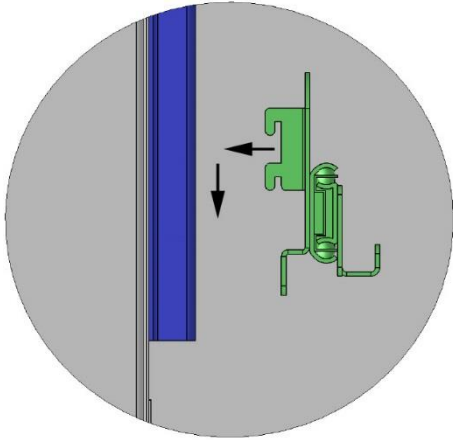


**Figure 8: Standard Shelf Installed on Mounting Brackets**

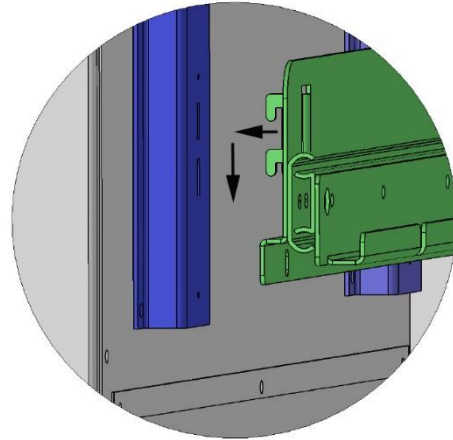
# INSTALLATION (CONTINUED)

## SRI6PF and SRI20PF Sliding Shelf Installation

**Note:** The SRI6PF does not come with a sliding shelf mounts. Sliding mounts for the SRI6PF must be purchased separately

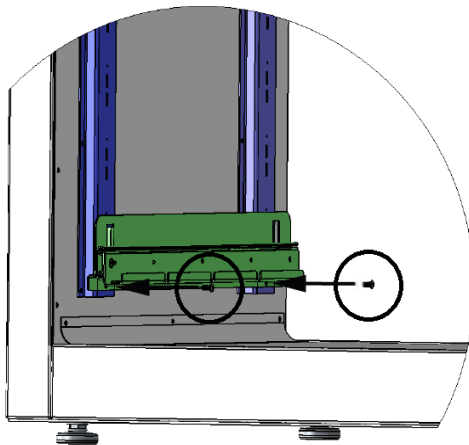


**Figure 10: Sliding Shelf Mounting Bracket Installation**

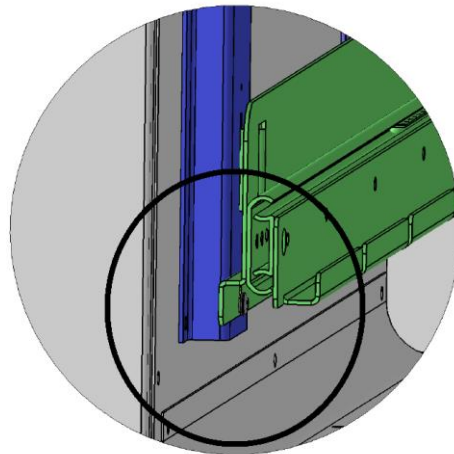


**Figure 9: Sliding Shelf Mounting Bracket Installation**

1. Insert the sliding bracket's two pairs of tabs (front and back) into the slots on the shelf standards. See Figure 10.
2. Slide the bracket down so that the tabs are securely seated in the mounting slots. See Figure 9.
3. Secure the bottom flange of the sliding bracket to the shelf standard rails by threading and screwing in 2 screws, on the front and back of the flange. See Figures 11 and 12.
4. Repeat the process on the opposite side of the chamber with the second sliding mounting bracket.
5. Install 1 shelf on the 2 sliding mounting brackets.



**Figure 12: Sliding Mounting Bracket Screws**



**Figure 11: Sliding Mounting Bracket Front Screw Installed**



# GRAPHIC SYMBOLS

The incubator is provided with graphic symbols on its interior and exterior surfaces. The symbols identify hazards and the functions of the adjustable components, as well as important notes in the user manual.

Symbol	Definition
	Indicates that you should consult your user manual for further instructions. Indique que l'opérateur doit consulter le manuel d'utilisation pour y trouver les instructions complémentaires.
	Indicates Temperature Repère température
	Indicates the Over Temperature Limit system Indique le système de dépassement de température
	Indicates AC Power Repère le courant alternatif
	Indicates I/ON and O/OFF I repère de la position MARCHÉ de l'interrupteur d'alimentation O repère de la position ARRÊT de l'interrupteur d'alimentation
	Indicates protective earth ground Repère terre électrique
	Indicates UP and DOWN respectively Touches de déplacements respectifs vers le HAUT et le BA
	Indicates Manually Adjustable Indique un bouton réglable manuellement
	Indicates Potential Shock Hazard Signale danger électrique
	Indicates the unit should be recycled (Not disposed of in land-fill) Indique l'appareil doit être recyclé (Ne pas jeter dans une décharge)

# CONTROL PANEL OVERVIEW



Figure 13: SRI6PF and SRI20PF Control Panel



## Power Switch

The green power switch on the panel controls all power to the unit and its systems. The switch illuminates when in the On position ( I ).

## Time Display

The green LED display labeled TIME on the left side of the panel operates as a 24-hour clock (00:00 – 23:59). During normal operations, it displays the current time. When setting the start times of the automatic day – night illumination and temperature cycle it shows the **Daytime start time** and the **Nighttime start time** separately. Three LED lights immediately below the Time screen indicate the present mode of display: Current Time, adjustable Daytime start time, and the adjustable Nighttime start time.

## Temperature Display

Marked SET TEMPERATURE, this digital display shows the air temperature in the incubation chamber, accurate to 0.1°C. The display can also show the adjustable temperature set points of the Day and Night Modes, as well as display value adjustments during temperature calibrations.



Just below the Temperature Display are two LED lights, **Day Temp** and **Night Temp**. These indicate which mode the incubator is running in (Day or Night), as well as which mode's temperature set point is being displayed when adjusting the set points.

## Temperature and Timer Control Arrows



**Temperature functions:** The arrow buttons are used to adjust the temperature set points of the Day and Night Modes. When the display is in its temperature calibration menu, the arrow keys are used to make calibration adjustments. **Time functions:** When the time display is in the Time Set Up menu, the arrow buttons adjust the Current Time, then the auto cycle Daytime and Nighttime start times.

# CONTROL PANEL (CONTINUED)

## Enter Button

The ENTER button is used to save adjustments to the Current Time as well as the auto cycle Day and Night start times while in the Time Set Up menu. The Enter button can also be used to scroll forward through the menu.



## Mode Button

Pressing and immediately releasing the button enters the Time Setup menu. Pressing and holding the Mode button for 5 seconds switches the incubator between the Daytime and Nighttime modes when the day – night auto cycle is not running.



## Cycle Start Button

Pressing and holding this button for 2 seconds will launch the day – night auto cycle, or terminate the cycle if it is running. The green PROGRAM ACTIVE indicator to the right of the button illuminates when the auto cycle is running.



## Heating and Cooling Light

The green pilot light located beneath the label TEC ACTIVATED illuminates whenever the Peltier TEC-H device is chilling or heating the chamber. The light will be on almost continually during normal operations as the unit makes continual, small temperature compensations.



## Set Over Temperature

The OTL is a mechanical heating cut off system that operates independently of the digital temperature controller. It guards against failures of the digital controller that would allow the chamber temperature to rise past the controller set point. Please see the [Over Temperature Limit System](#) description in the Theory of Operations section (page 21) for a complete explanation.



## OTL Light

The red pilot light marked OVER TEMPERATURE ACTIVATED illuminates when the Over Temperature Limit system cuts power to the Peltier TEC heating circuits. Under normal operating conditions this indicator should never turn on.



# OPERATION

## *THEORY OF OPERATION*

The SRIPF family of fly incubators is designed to provide a variable temperature and illumination environment suitable for the cultivation and storage of fruit flies (*Drosophila melanogaster*). The incubator runs in one of two modes, Daytime and Nighttime. In its Daytime mode, the incubator provides continual illumination in the incubation chamber using two side-mounted white light LED bars. In Nighttime Mode, the chamber is left dark though a small LED bar at the top of the chamber will illuminate whenever the chamber door is opened.

The Day and Night Modes have independent, programmable temperature set points. Both are set to 20°C at the factory, but can be adjusted to different temperatures in order provide a thermal variation between the modes.

The SRIPF incubator comes from the factory set to run indefinitely in the Daytime Mode. Users can manually switch between it and the Nighttime Mode by pressing and holding the MODE button. The incubator is also provided with a Day – Night Auto Cycle, which when launched cycles the between the two modes until manually terminated. As set at the factory, the cycle transitions between modes are 12 hours apart. These start time points can be adjusted using the incubator controls.

During Day Mode operations the unit microprocessor controller automatically compensates for a small amount of extra heat generated by the active LED light bars in the incubation chamber.

### **Heating and Cooling**

Conventional low-temperature capable incubators rely on a competition between a refrigeration compressor and a resistive heating element to achieve stable chamber temperatures. SRIPF incubators employ an alternative, power saving thermoelectric cooling-and-heating device.

The TEC-H operates using the Peltier effect, in which the junctures between two electrified conductive plates generate a gradient of temperature differences. In other words, a current between the conductors produces a flow of heat away from one plate to the other. The direction of this gradient can be flipped by reversing the direction of the current. The sandwiched TEC conductors effectively operate as a reversible heat pump that is significantly more efficient than a compressor – element pairing. This power use efficiency results in far less waste heat and a corresponding reduction in cooling demand placed on laboratory air conditioning systems.

Heating and cooling of the incubation chamber are controlled by a microprocessor controller. The controller stores the Daytime mode and Nighttime mode temperature set points. The controller monitors the air temperature of the incubation chamber using a solid state sensor probe located in the chamber airstream. When an air temperature deviation from the active set point is detected, the controller pulses power to the TEC-H device to add or remove heat from the chamber. Heated or chilled air is circulated through the chamber using a fan attached to the TEC-H.

The controller employs proportional-integral-derivative (PID) analytical feedback-loop functions when measuring and controlling the chamber temperature. The intensity of PID-controlled heating or chilling is proportional to the difference between the measured chamber temperature and the current temperature set point. The frequency of heating or chilling pulses is derived from the rate of change in the difference. Integrator feedback slows the rate of heating or chilling as the chamber temperature approaches the set point, which helps prevent overshoots.

# OPERATION (CONTINUED)

During normal operations, with the chamber door closed, the Peltier device pulses heat or cold to the chamber almost continuously, as indicated the green TEC Activated pilot light. These are short, low-power pulses to compensate for deviations of a hundredth degree Celsius ( $\pm 0.01^{\circ}\text{C}$ ).

As a solid state device, the Peltier TEC-H offers significant maintenance savings cost. The device can be replaced by a service technician using a screwdriver and a nut driver. It does not require a certified refrigeration specialist with refrigeration tools, replacement coolant fluid, and does not contain a system of easily deformed, pressurized fluid vessels.

## ***Door Alarm***

Leaving the door open for extended periods disrupts the temperature uniformity and stability of the incubation chamber, and may result in significantly increased power use as the controller attempts to compensate for the disruption. The SRIPF incubator is equipped with a magnetic induction door alarm, which activates when the door is opened and its two sensor components are moved out of range of one another for 60 seconds. When the alarm is active, an audio alert will sound and the control panel display will flash. The alarm may be turned off using the Arrow buttons. Please see the [Turn Alarm Off / On](#) procedure on page 36.

## ***Accessory Compatibility***

Make sure that any accessory equipment you will be using inside an SRIPF incubator can safely operate within your selected temperature range. Powered accessories such as, stirrers or shakers that produce significant waste heat may interfere with the temperature uniformity and operating range of the chamber. Additionally, fruit flies can produce aerosolized acidic metabolic byproducts that may affect the long-term performance of accessory equipment.

## ***The Over Temperature Limit System***

When set, the OTL system prevents runaway heating in the event of a failure of the main temperature microprocessor or its sensor probe. It does so by cutting off the current through the Peltier TEC device in the direction that transmits heat into the incubation chamber. This cutoff allows the device's refrigeration function to continue operating without interruption and takes place whenever the temperature in the cultivation chamber exceeds the OTL setting. The OTL is provided with an independent temperature probe.

The system is set **by the end-user** at approximately  $1^{\circ}\text{C}$  above the current chamber temperature, typically when operating stabilized at the warmest application temperature. This is typically when the unit has been functioning in the Day Mode for several hours. Setting the over temperature limit while the unit is operating in the Night Mode or phase risks tripping the OTL when the unit transitions to a warmer day temperature.

Because of its nature as a cutoff and its lack of PID analytics, the OTL cannot deliver the same degree of temperature stability and measurement precision as the digital display and controls. The OTL System should only be used as a means of heating regulation for the cultivation chamber until a failed processor board and its temperature probe can be repaired or replaced.

The OTL will not prevent a rise in heat caused by a complete failure of the Peltier TEC-H itself. With the loss of the refrigeration function, the chamber temperature will rise to the ambient room temperature plus 1 or  $2^{\circ}\text{C}$ .

# OPERATION (CONTINUED)

## PREPARING THE INCUBATOR

Setting up the incubator for use in a new workspace environment requires an 8-hour period for the unit to come up to and stabilize at the set point temperature, prior to loading the incubation chamber with samples (step 5e below). During this period, the chamber must be powered continually, and the chamber door closed. Allowing time for stabilization helps protect samples. It is also necessary in order to perform the optional Temperature Display Accuracy Verification procedure (step 5f), as well as any resulting display calibration.

Perform the following steps and procedures to prepare the incubator for use each time it is installed in a new location:

1. **Optional:** A clean and disinfected thermocouple probe for performing the optional temperature display accuracy verification may be inserted through door space into the cultivation chamber now. This saves time by allowing the unit chamber temperature to stabilize undisturbed prior to the verification procedure.
  - a. See the [Temperature Display Accuracy Verification procedure](#) on page 28 for the correct introduction and placement of the thermocouple probe.
2. Verify that the workspace power supply and the chamber power requirements listed on the unit data plate have been matched.
  - a. See the [Power Source Requirement](#) entry on page 12.
3. Plug in the power cord.
  - a. Plug the female end of the supplied power cord into the inlet on the incubator.
  - b. Plug the male end into the workspace supply receptacle (outlet).
4. Place the **Power** switch in the on ( I ) position.
  - a. The controller display will illuminate. The unit comes from the factory set to run in manual Night Mode with a set point of 20°C.
5. Perform the following procedures in the Operation section to finish preparing the chamber:
  - a. [Set the Current and Cycle Start Times](#) page 23
  - b. [Turn Off the OTL](#) page 25
  - c. [Set the Night Mode Temperature Set Point](#) page 26
  - d. [Set the Day Mode Temperature Set Point](#) page 27
  - e. Allow the incubator to operate undisturbed for 8 hours to stabilize thermally before continuing. This also prepares the unit for the optional verification procedure below.
  - f. **Optional:** [Verify Temperature Display Accuracy](#) page 28
  - g. [Set the Over Temperature Limit Control](#) page 30
  - h. [Load the Chamber](#) page 32



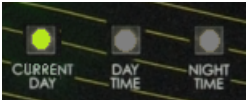



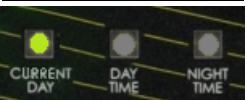


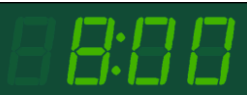
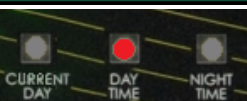


Wait 8 Hours

# OPERATION (CONTINUED)




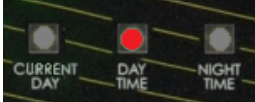












## SET CURRENT AND CYCLE START TIMES

This procedure sets the incubator clock time to your local time, then allows you to adjust the Auto Cycle start times for the Day and Night modes. The incubator comes from the factory set to US Pacific Time. The Auto Cycle Daytime start comes from the factory set to 08:00 (8 am), and the Nighttime start is 20:00 (8 pm).

<p>1. Press and release the <b>Mode</b> button to enter the Time Set Up menu.</p> <p> a. The Current LED will stay lit, and the Temperature display will turn off</p> <p>b. The Time display will show a blinking, adjustable time setting.</p>	<p style="text-align: center;"><b>TIME</b></p>   <p style="text-align: center;"><b>Factory Current Time</b></p>
<p>2. Adjust the Current time to match your local time using the <b>UP</b> and <b>DOWN</b> arrows.</p> <p> a. 24-hour clock afternoon and evening times are 12 hours greater than the 12-hour clock PM equivalents. Example: 1 PM = 13:00; 6 PM = 18:00; 9 PM = 21:00. 12 AM = 00:00.</p> <p></p> <p><b>Note:</b> Skip to Step 3 if you do not wish to adjust the current clock time.</p>	<p style="text-align: center;"><b>TIME</b></p>   <p style="text-align: center;"><b>Adjusted Clock Time</b></p>
<p>3. Save the adjusted Current time.</p> <p> a. Press and release the <b>Enter</b> button.</p> <p>b. This saves the flashing time shown on the display as the new Current time.</p>	<p style="text-align: center;"><b>TIME</b></p>  <p style="text-align: center;"><b>Adjusted Time Saved</b></p>
<p>4. The display will automatically advance to the auto cycle Daytime Start Time, after pressing Enter.</p> <p>a. Time Display continues to flash but now displays the adjustable Daytime start time.</p> <p>b. The Current Time indicator LED will extinguish, the Daytime LED indicator will illuminate.</p>	<p style="text-align: center;"><b>TIME</b></p>   <p style="text-align: center;"><b>Cycle Daytime Start: Factory Setting</b></p>

*Procedure continued on next page*

# OPERATION (CONTINUED)

Set Times (Continued)	
  <p>5. Use the <b>UP</b> and <b>DOWN</b> arrow keys to adjust the cycle Daytime Start Time.</p> <p><b>Note:</b> Skip to Step 6 if you do not wish to change the Daytime Start time.</p>	  <p>Adjusted Daytime Start</p>
 <p>6. Save the adjusted cycle Day Start time.</p> <p>a. Press the <b>Enter</b> button after adjusting the Day Start Time.</p>	 <p>Adjusted Time Saved</p>
<p>7. The display will automatically advance to the auto cycle Nighttime Start Time, after pressing Enter.</p> <p>a. The Daytime indicator LED will extinguish, and the Night Time indicator will illuminate.</p> <p>b. The flashing Time Display will now show the adjustable Nighttime Start Time.</p>	<p>TIME</p>   <p>Cycle Nighttime Start: Factory Setting</p>
  <p>8. Use the <b>UP</b> and <b>DOWN</b> arrow keys to adjust the Nighttime Start Time.</p> <p>a. 24-hour clock afternoon and evening times are 12 hours greater than the 12-hour clock PM equivalents. Example: 1 PM = 13:00; 6 PM = 18:00; 9 PM = 21:00. 12 AM = 00:00.</p> <p><b>Note:</b> Skip to Step 9 if you do not wish to change the Nighttime start time.</p>	<p>TIME</p>   <p>Adjusted Night Start</p>
 <p>9. Save the adjusted cycle Night Start Time.</p> <p>a. Press <b>Enter</b> after adjusting the Night Start Time.</p>	<p>TIME</p>  <p>Adjusted Time Saved</p>
<p>10. The display will exit the Time Set Up menu and resume showing the Current time, after pressing Enter.</p> <p>a. The Time Display will cease blinking.</p> <p>b. The Temperature Display will turn on.</p> <p>c. The Nighttime LED will extinguish, and the Current time (Day) LED will illuminate.</p>	<p>TIME</p>   <p>Returned to Current Time Display</p>

*End of procedure*



# OPERATION (CONTINUED)

---

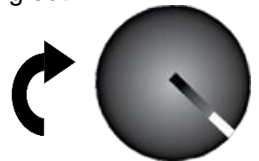
**Note:** The OTL should ship from the factory set to the maximum position.

---

## *TURN OFF THE OTL*

Always set the OTL dial to its maximum position prior to adjusting the Day temperature mode. This prevents the OTL system from interfering with raising the temperature set point or with carrying out a temperature display calibration.










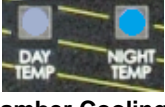
1. Turn the **Over Temperature Limit control dial** clockwise to the maximum position indicated by the largest dot.
2. Leave the control at its maximum position until the Set the Day Mode and Night Mode procedures have been completed, as well as the optional Temperature Display Accuracy Verification and any resulting Calibration procedures have also been completed.
3. See page 30 for instructions on how to set the OTL after the above procedures are completed.



# OPERATION (CONTINUED)

## SET THE NIGHTTIME TEMPERATURE SET POINT

The incubator comes from the factory with a Night Mode set point of 20°C. Perform the steps below to adjust the Night set point to that of your laboratory or study protocol, if other than 20°C.


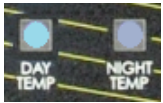








<p><b>Note:</b> Terminate the auto cycle if it is running. Press and hold the <b>Cycle Start</b> button for two seconds. The Program Active Light will extinguish.</p> <p>1. Place the incubator into Manual Nighttime Mode</p> <p>a. To switch from Daytime to Night, press and hold the <b>Mode</b> button for 5 seconds. The Day Temp indicator will extinguish, the blue Night Temp will illuminate.</p>	<p><b>Program Active Light Off</b></p>  <p><b>Nighttime Mode</b></p> 
<p>2. Place the Temperature display into the Nighttime Set Point mode.</p> <p> a. Press and release the <b>Up</b> or the <b>Down</b> arrow button.</p> <p> b. The Time display will go dark.</p> <p>c. The Temperature display will briefly flash the letters “SP”, then show the blinking, adjustable Night Temp set point.</p>	<p><b>SET TEMPERATURE</b></p>  <p><b>SET TEMPERATURE</b></p>  <p><b>Initial Set Point</b></p>
<p>3. Enter a new Night set point.</p> <p> a. Use the <b>Up</b> and <b>Down</b> arrow buttons.</p> <p><b>Note:</b> If neither button is pressed within 5 seconds, the Temperature display will stop blinking and return to displaying the current temperature of the incubator.</p>	<p><b>SET TEMPERATURE</b></p>  <p><b>New Set Point</b></p>
<p>4. Wait 5 seconds after entering the new set point.</p> <p>a. The Temperature display will cease flashing, and the Time display will illuminate.</p> <p>b. The Temperature display will revert to showing the Current chamber air temperature.</p> <p>c. The adjusted set point is now saved, and the incubator will begin cooling or heating to achieve the new Nighttime set point.</p>	<p><b>SET TEMPERATURE</b></p>  <p><b>Chamber Cooling to Achieve the New Set Point</b></p> 

*End of procedure*

# OPERATION (CONTINUED)

## SET THE DAYTIME TEMPERATURE SET POINT

The incubator comes from the factory with a Day Mode set point of 20°C. Perform this procedure if your laboratory or study protocol calls for a Day temperature other than 20°C.

<p><b>Note:</b> Terminate the auto cycle if it is running. Press and hold the <b>Cycle Start</b> button for two seconds. The Program Active Light will extinguish.</p> <p>1. Place the incubator into Manual Day Mode.</p> <p>a. To switch from Night to Day, press and hold the <b>Mode</b> button for 5 seconds. The Night Temp indicator will extinguish, the blue Day Temp will illuminate.</p>	<p><b>CYCLE START</b></p> <p><b>Program Active Light Off</b></p>  <p><b>Daytime Mode</b></p> 
<p>2. Place the Temperature display into the Day Set Point mode.</p> <p> a. Press and release the <b>Up</b> or the <b>Down</b> arrow button.</p> <p> b. The Time display will go dark.</p> <p>c. The Temperature display will briefly flash the letters "SP", then show the blinking, adjustable Day Temp set point.</p>	<p><b>SET TEMPERATURE</b></p>  <p><b>SET TEMPERATURE</b></p>  <p>Initial Set Point</p>
<p>3. Enter a new Day set point.</p> <p> a. Use the <b>Up</b> and <b>Down</b> arrow buttons.</p> <p><b>Note:</b> If neither key is pressed within 5 seconds, the Temperature display will stop blinking and return to displaying the current temperature of the incubator.</p>	<p><b>SET TEMPERATURE</b></p>  <p>Adjusted Day Set Point</p>
<p>4. Wait 5 seconds after entering the new set point.</p> <p>a. The Temperature display will cease flashing, and the Time display will illuminate.</p> <p>b. The Temperature display will revert to showing the Current chamber air temperature.</p> <p>a. The adjusted set point is now saved, and the incubator will begin cooling or heating to achieve the new Day set point.</p>	<p><b>SET TEMPERATURE</b></p>   <p>Chamber Heating to Achieve the New Set Point</p>
<p><b>Optional:</b> Leave the incubator in the Day Mode if you will be performing the optional Temperature Display Accuracy Verification procedure.</p>	

End of procedure

# OPERATION (CONTINUED)

## TEMPERATURE DISPLAY ACCURACY VERIFICATION

**Note:** Performing a temperature accuracy verification requires a temperature reference device. Please see the [Reference Sensor Devices entry](#) on page 11 for the device requirements.

**Optional:** The unit temperature display was calibrated at the factory at 20°C. A verification of the display accuracy may be carried out when preparing the incubator for use if required by your laboratory or production protocol. The verification procedure compares the displayed temperature of the SRIPF with the actual chamber air temperature, as provided by a calibrated reference device.

Perform the Verification procedure with the incubator operating in the manual Day Mode, as the LED light bar introduces heat into the chamber that should be accounted for. If a difference between the actual and displayed temperatures is discovered, perform a temperature calibration. Please see the [Calibrate Temperature Display procedure](#) on page 40 in the User Maintenance section.

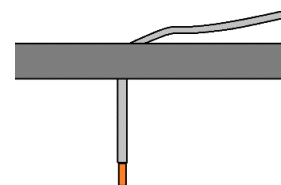
### Probes

A temperature reference device sensing probe may be introduced through the access port. Carefully place the port stopper over the probe wires. The probe may also be introduced through the chamber door space. Use non-stick, non-marking tape to secure the wires to the incubator body, and to seal any exterior gaps. The door must close and latch fully.



**Figure 14: Example of introducing probes through the door space**

Place the head of the sensor probe as close as possible to the geometric center of the incubation chamber. The probe sleeve may be taped to the shelving using non-marking, non-stick tape, as long as the exposed copper end is 2 inches (5cm) away from the shelf (see Figure 15). An exposed sensor probe in direct contact with the shelving may experience heat sinking, which can result in an inaccurate temperature reading.



**Figure 15: Probe End 2 inches (5cm) From Shelf Surface**

### Stability

After introducing and placing the temperature probe, switch the incubator to its manual Day Mode and allow the chamber to run undisturbed for 8 hours, often done overnight, prior to performing the verification. Do not change modes or launch the Day – Night Auto Cycle during this period, as doing so risks destabilizing the chamber air temperature.

Prior to performing the verification, the chamber must operate at the verification temperature set point for **at least 1 hour with no fluctuations** greater than  $\pm 0.1^\circ\text{C}$  in order to be considered stabilized. Failure to wait for stabilization will result in an inaccurate verification. Do not open the door during the stabilization period or during the verification procedure.



Wait 8 Hours

*Procedure continued on next page*

# OPERATION (CONTINUED)

## Temperature Accuracy Verification

1. Once the incubation chamber has stabilized, operating in the Manual Day Mode, compare the reference temperature device and chamber temperature display readings.
  - a. If the readings are the same, or if a difference between the two (2) falls within the acceptable range of your protocol, the display is accurately showing the chamber air temperature.  
**The Temperature Verification procedure is now complete.**
  - b. See step 2 if a difference falls outside the acceptable range of your protocol.

Reference Device

8 20.6 °C

SET TEMPERATURE

20.5 ✓

2. If there is an unacceptable difference, a display **temperature calibration** must be performed to match the display to the reference device.
  - a. Please see page 40 in the User Maintenance section.

Reference Device

8 21.1 °C

SET TEMPERATURE

20.5 ✗

*End of procedure*

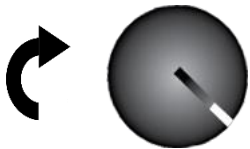






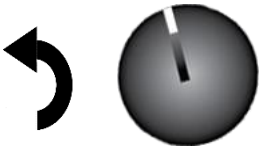
# MAINTENANCE (CONTINUED)

## SET THE OVER TEMPERATURE LIMIT

**Note:** Test the OTL for functionality once per year.

The incubator temperature must be stable running at your Day Mode temperature set point for at least 1 hour prior to setting the OTL. Setting the OTL while running in the Night Mode risks tripping the system whenever the unit is switched to a warmer Daytime temperature.




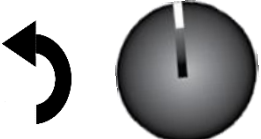




Perform the following steps to set up the **Over Temperature Limit** system for normal use:

Setting the OTL Heating Cutoff	Example
<p>1. If not already set to maximum, turn the <b>Set Over Temperature Limit dial</b> all the way clockwise.</p>	
<p>2. Increase the temperature set point to +1°C above your day application temperature. The temperature set point will be restored to your application temperature during step 7.</p> <p> a. Briefly, press the <b>Up Arrow button</b> once, to place the temperature display in its blinking, adjustable set point mode.</p> <p> b. Then use the <b>Up Arrow button</b> to increase the temperature set point by +1°C.</p> <p>c. After entering the new set point, wait 5 seconds for the display to exit its set point adjustment mode, automatically saving the new set point.</p> <p><b>Note:</b> If neither arrow key is pressed within 5 seconds of the temperature display being placed in the adjustable set point mode, the display will stop blinking and return to showing the current temperature of the incubator.</p>	<p>SET TEMPERATURE</p>  <p>Entering Set Point Mode</p> <p>SET TEMPERATURE</p>  <p>Set Point Increased</p>
<p>3. After increasing the set point, wait for the incubation chamber to achieve and stabilize at the raised set point.</p> <p>a. After achieving the raised set point, there should be no temperature fluctuations of <math>\pm 0.1^\circ\text{C}</math> or greater for 15 minutes in order for the chamber to be considered stabilized, for this stage of the procedure.</p>	<p>SET TEMPERATURE</p>  <p>Unit Heating to New Set Point (21.5°C)</p>
<p>4. Once the chamber temperature has stabilized at the increased set point, turn the Over Temperature Limit <b>control dial</b> counterclockwise until the red Over Temperature Limit Activated light illuminates.</p> 	

Continued on next page

# MAINTENANCE (CONTINUED)

## Setting the OTL Heating Cutoff (Continued)

<p>5. Slowly turn <b>the dial</b> clockwise until the Over Temperature Limit Activated light turns off. Stop turning the control.</p> <p>a. The Over Temperature Limit is now set at approximately 1°C above the application temperature set point.</p>		
<p>6. Optional: You may turn the dial slightly to the left to bracket in even closer to the 1°C above your application temperature set point.</p>		
<p>7. Return the temperature set point to the application temperature of your study or lab protocol.</p> <p> a. Briefly, press the button once, to place the temperature display in its adjustable set point mode.</p> <p> b. Use down arrow key to lower the set point to your application temperature.</p>	<p>SET TEMPERATURE</p>  <p>Application Set Point Restored</p>	
<p>8. Leave the OTL dial set just above the activation point.</p>		

### Notes

If the OTL activates after an extended door opening, you may turn the dial very slightly to the right (clockwise), to deactivate the OTL, and leave the dial in that position.

If the OTL continues activating, check for ambient sources of heat or cold that may be adversely impacting the unit temperature stability. Check if any powered accessories in the chamber are generating heat. If you can find no sources of external or internal temperature fluctuations, contact Tech Support or your distributor for assistance.

*End of procedure*

# OPERATION (CONTINUED)

## *LOADING THE INCUBATOR*

Place items on the shelves inside the incubator chamber as evenly spaced as possible. Proper spacing allows for maximum air circulation and a high degree of temperature uniformity.

**End of the Preparing the Incubator Procedure**

## *ATTACHING EQUIPMENT TO THE INTERIOR ACCESSORY OUTLET*

The incubator has a 1A (maximum) accessory outlet located inside the chamber. The power switch on the front panel controls power to the accessory outlet. This outlet can power equipment such as magnetic stirrers, rockers, etc. Do not attach any equipment drawing more than 1A to this outlet.

Accessory equipment may produce additional heat. This heat could affect the temperature range and uniformity of this incubator. Verify that the incubator operates within your protocol's required temperature range when the accessory equipment is installed and operating.

## *HUMIDIFYING THE INCUBATOR*

Placing only a small number of open or breathable media containers in the incubator chamber may lead to excessive drying of sample media. Unusually dry environmental conditions may also contribute to sample drying.

To counteract this, Sheldon Manufacturing offers an optional humidity collection pan and tubing accessory kit: **Part Number 9900708**. The kit redirects moisture that normally condenses on the heat sink fins of the Peltier TEC-H heating and cooling device, and uses it to humidify the incubator. After ordering and receiving the kit, place the stainless steel pan on the lowest chamber surface. Connect the tubing that comes with the kit to the port on the back of the Peltier duct cover. Run the tubing down the back of the incubator behind the shelves, and secure the end of the tubing inside the pan. The pan is supplied with a copper slug to help prevent microbial contamination.

The humidification kit is intended for use while running **small loads**.



# OPERATION (CONTINUED)

## *MANAGING CONDENSATION*

Excessive condensation in the incubation chamber may create leaks around the chamber door, and may cause corrosion damage if allowed to continue for significant lengths of time.

Condensation takes place wherever the humidity level in the incubator chamber reaches the dew point. The dew point is the level of humidity at which the air cannot hold more water vapor. The warmer the air, the more water vapor it can hold. Evaporating sample media can be a source of chamber humidity.

As the level of humidity rises in an incubation chamber, condensate will first appear on surfaces that are cooler than the air temperature. Near the dew point, condensate forms on any item or exposed surface that is even slightly cooler than the air. When the dew point is reached, condensate will form on nearly all exposed surfaces.

Managing condensation primarily depends on either lowering the humidity level or increasing the air temperature in the incubator chamber.

---

**Note:** Rising or falling air pressure from the weather will adjust the dew point up and down in small increments. If the relative humidity in the incubation chamber is already near the dew point, barometric fluctuations may push it across the dew point threshold.

**Note:** Thin air at higher altitudes holds less humidity than the denser air found at or near sea level.

---

If condensate is forming in the incubation chamber, wipe down and dry the chamber, then check the following:

- Make sure items on the shelves are evenly spaced to allow for good airflow.
- Empty the optional accessory humidity collection pan frequently, if in use.
- Are frequent or lengthy chamber door openings causing significant temperature disruptions and chilling the chamber surfaces? If so, reduce the number of openings.
- Does the ambient humidity in the room exceed the stated operating range of 80% relative environmental humidity? If so, lower the room's humidity.
- Is the chamber door closing and latching properly? Is the door gasket leaking? Check the gasket for damage, wear, or signs of brittleness or dryness. Replace the gasket if needed.
- Is the incubator exposed to an external flow of cold air such as an air-conditioning vent or a door to a cooler hallway or adjacent room? Block or divert the air, or move the incubator.

# OPERATION (CONTINUED)

---

**Note:** In the event of a power outage, the unit will restart in the last mode it was operating in. The incubator current time will automatically adjust to compensate. If active at the time of the outage, the Auto Cycle will resume running and automatically advance to the Day or Night Mode, synched with the updated current time.

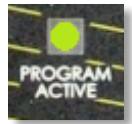
---

## *LAUNCHING THE AUTO CYCLE*

To start the day – night Auto Cycle carry out the following step:



1. Press and hold the **Cycle Start** button for two seconds.
2. The Program Active LED indicator next to the **Cycle Start** button will illuminate.
3. The auto cycle will now run indefinitely, switching between Day and Night Modes until manually terminated.

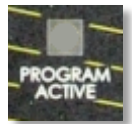


## *ENDING THE AUTO CYCLE*

To terminate the Auto Cycle perform the following step:



1. Push and hold the **Cycle Start** button for two seconds.
2. The Program Active indicator next to the **Cycle Start** button will extinguish.










This page left blank

# OPERATION (CONTINUED)

## TURN ALARM OFF / ON

Perform the following steps to turn the door alarm off or on. Note that once set to off the alarm will not activate until the user has turned it back on. This procedure is applicable to units manufactured after January 15, 2015, or older units retrofitted with a new door alarm control chip.








### Turn the Door Alarm Off

Alarm OFF	
<p>1. Place the temperature display in the adjustable set point menu for either the Daytime or Nighttime mode.</p> <p> a. Press and release either the <b>Up</b> or the <b>Down</b> arrow key while in either mode, until the screen flashes “SP”.</p> <p> b. The display will then show an adjustable, flashing temperature set point.</p>	<p>SET TEMPERATURE</p>  <p>Set Point Indicator</p> <p>SET TEMPERATURE</p>  <p>Current Set Point, Adjustable</p>
<p>2. Press and hold the <b>Up arrow</b> until the temperature display reads “dO”.</p> <p> a. “dO” indicates that “door alarm off” is selected.</p>	<p>SET TEMPERATURE</p>  <p>Door Alarm Off</p>
<p>3. Release the Up arrow.</p> <p>a. “dO” will flash approximately six times.</p> <p>b. The display will then revert to showing the current chamber temperature.</p> <p>c. The door open alarm is now set to off, and the temperature set point <b>has not been changed</b>.</p>	<p>SET TEMPERATURE</p>  <p>Current Temperature</p>

*Procedure continued on next page*

# OPERATION (CONTINUED)

## Turn the Door Alarm On

Alarm ON	
<p>1. Place the temperature display in the adjustable set point menu for either the Daytime or Nighttime mode.</p> <p> a. Press and release either the <b>Up</b> or the <b>Down</b> arrow key while in either mode, until the screen flashes “SP”.</p> <p> b. The display will then show an adjustable, flashing temperature set point.</p>	<p>SET TEMPERATURE</p>  <p>Set Point Indicator</p> <p>SET TEMPERATURE</p>  <p>Current Set Point, Adjustable</p>
<p>2. Press and hold the <b>Up arrow</b> until the temperature display reads “dl”.</p> <p> a. “dl” indicates that “door alarm on” is selected.</p>	<p>SET TEMPERATURE</p>  <p>Door Alarm On</p>
<p>3. Release the up arrow.</p> <p>a. “dl” will flash approximately six times.</p> <p>b. The display will then revert to showing the current chamber temperature.</p> <p>c. The door alarm is now set to on, and the temperature set point <b>has not been changed</b>.</p>	<p>SET TEMPERATURE</p>  <p>Current Temperature</p>

*End of procedure*

# USER MAINTENANCE



**Warning:** Prior to any maintenance or cleaning of this unit, disconnect the power cord from the power supply.

**Avertissement:** Avant d'effectuer toute maintenance ou entretien de cet appareil, débrancher le cordon secteur de la source d'alimentation.

## *CLEANING AND DISINFECTING*

If a hazardous material or substance has spilled in the unit, immediately initiate your site Hazardous Material Spill Containment protocol. Contact your local Site Safety Officer and follow instructions per the site policy and procedures.

The unit chamber should be cleaned and disinfected prior to first use. Periodic cleaning and disinfection are required to prevent microbiological contamination.

Do not use spray on cleaners or disinfectants. These can leak through openings and coat electrical components. Do not use cleaners or disinfectants that contain solvents capable of harming mill finish aluminum or paint coatings. **Do not use chlorine-based bleaches or abrasives; these will damage the chamber liner.** Consult with the manufacturer or their agent if you have any doubts about the compatibility of decontamination or cleaning agents with the parts of the equipment or with material contained in it.



**Warning:** Never clean the unit with alcohol or flammable cleaners.

**Avertissement:** Ne jamais nettoyer l'appareil à l'alcool ou avec des nettoyeurs inflammables.

## *Cleaning*

1. Remove all non-attached accessories (shelves, racks, and any additional items) from the chamber.
2. Clean the chamber interior with a mild soap and water solution, including all corners.
3. Take special care when cleaning chamber sensor probes.
4. Clean all removable accessories and components.
5. Clean and disinfect any attached sample tubing and replace if discoloring is present.
6. Rinse the chamber surfaces and shelving with distilled water and wipe dry with a soft cloth. **Do not use deionized water.**

# USER MAINTENANCE (CONTINUED)

## *Disinfecting*

Disinfect the unit chamber on a regular basis. Perform the following steps to manually disinfect the chamber:

1. Turn the unit off. Open the door and carry out your laboratory, clinical, or production space disinfection protocol.
2. Disinfect the unit chamber using commercially available disinfectants that are non-corrosive, non-abrasive, and suitable for use on painted surfaces. If disinfecting external surfaces use disinfectants that will not damage painted metal or plastic. Contact your Site Safety Officer for detailed information on the disinfectants compatible with your cultivation or culturing applications.
3. If permitted by your protocol, remove all interior accessories (shelving and other non-attached items) from the chamber when disinfecting.
4. Disinfect all surfaces in the chamber, making sure thoroughly disinfect the corners. Exercise care to avoid damaging the sensor probes.
5. Gas concentrations from evaporating disinfecting agents can inhibit growth or cause metabolic symptoms in microbiological sample populations. Make sure that chlorines, amphyls, quaternary ammonias, or any other overtly volatile disinfecting agents have been rinsed or otherwise removed from the chamber surfaces, prior to placing samples in the chamber.

*End of procedure*

## *MAINTAINING ATMOSPHERIC INTEGRITY*

Periodically, inspect the door latch, trim, catch, and gasket for signs of deterioration. Failure to maintain the integrity of the door system shortens the life span of the incubator.

## *ELECTRICAL COMPONENTS*

Electrical components do not require maintenance. If the incubator fails to operate as specified, please contact your Shel Lab Dealer or [Sheldon Technical Support](#) for assistance (please see page 7 **Error! Bookmark not defined.**).

# MAINTENANCE (CONTINUED)

## CALIBRATE THE TEMPERATURE DISPLAY

**Note:** Performing a temperature display calibration requires a temperature reference device. Please see the [Reference Sensor Devices entry](#) on page 11 for device requirements.

Temperature calibrations are performed to match the unit temperature display to the actual air temperature inside the incubation chamber. The actual air temperature is supplied by a calibrated reference sensor device. Calibrations compensate for drifts in the unit microprocessor controller as well as those caused by the natural material evolution of the sensor probe in the chamber space. Calibrate as often as required by your laboratory or production protocol, or regulatory compliance schedule.

### Probes

A reference device sensor probe may be introduced through the access port. Carefully place the port stopper over any probe wires (see figure 16). Probes may also be introduced through the chamber door space. Use non-stick, non-marking tape to secure the wires to the incubator body and seal any exterior gaps. The door must close and latch fully.

Place the head of the sensor probe as close as possible to the geometric center of the chamber. A thermocouple sensor probe sleeve may be taped to the shelving, as long as the exposed copper end is 2 inches (5cm) away from the shelf (see Figure 17). An exposed sensor probe in direct contact with the shelving may experience heat sinking, which can result in an inaccurate temperature reading.

### Stability

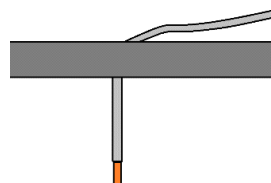
After introducing and placing the temperature probe, place the unit into the manual Day Mode (Step 1 on the next page). The Day Mode temperature set point should be that of your application's day period. Allow the unit to operate undisturbed for at least 8 hours—for example overnight—before starting the calibration (Step 2). This allows the chamber temperature to stabilize.

Prior to a calibration, the chamber must operate at the Day calibration temperature set point for **at least 1 hour with no fluctuations** of  $\pm 0.1^{\circ}\text{C}$  or greater in order to be considered stabilized. Failure to wait for stabilization will result in an inaccurate display calibration and reading. Do not open the door during the stabilization period or during the calibration.

Following the day calibration, place the unit in its manual Night Mode (Step 11) and **wait 2 hours**. **The temperature display must be calibrated separately in the manual Day and Night Modes** to compensate for the extra heat generated during the Day Mode by the day illumination LEDs in the chamber. Accurate calibrations cannot be carried out while the auto cycle is running.










**Figure 16: Introducing a sensor probe through the access port.**



**Figure 17: Probe End 2 inches (5cm) From Shelf Surface**

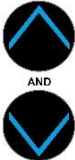









# MAINTENANCE (CONTINUED)

Calibration—Day Mode	Program Active Light Off
<p>1. The incubator should already be running in Day Mode with the auto cycle turned off during the stabilization period and calibration.</p> <ol style="list-style-type: none"> <li>Turn off the auto cycle if it is running by pressing and holding the <b>Start Cycle button</b> for 2 seconds.</li> <li>If not already in the Daytime Mode, place the incubator in Day Mode by pressing and holding the <b>MODE button</b> for 5 seconds.</li> </ol>	 <p>Day Mode</p> 
<p>2. Allow the unit to run undisturbed, with the chamber door closed for at least 8-hours in the Day Mode to stabilize.</p> <ol style="list-style-type: none"> <li>The chamber is stabilized when no temperature fluctuations of <math>\pm 0.1^{\circ}\text{C}</math> or greater have been detected by the reference device for 1 hour.</li> <li>If the chamber door is opened at any time during the procedure the chamber must be allowed to re-stabilize.</li> </ol>	 <p>Wait 8 Hours</p>
<p>3. Once the temperature has stabilized, compare the reference device and the incubator display temperature readings.</p> <ol style="list-style-type: none"> <li>If the readings are the same or the difference between the two falls within the acceptable range of your protocol, <b>the incubator is calibrated for Day Mode temperature.</b> Advance to Step 11 to start the Night Mode calibration on page 44.</li> <li>If a difference falls outside of your protocol range, advance to step 4.</li> </ol>	<p>Reference Device</p>  <p>SET TEMPERATURE</p> 
<p>4. A display calibration adjustment must be entered to match the display to the reference device. See next step.</p>	<p>Reference Device</p>  <p>SET TEMPERATURE</p> 







Procedure continued on next page

# MAINTENANCE (CONTINUED)

Daytime Temperature Calibration (Continued)	
<p>5. Place the temperature display in its calibration mode.</p> <div style="display: flex; align-items: center;">  <div style="margin-left: 20px;"> <p>a. Press and hold both the <b>UP and DOWN</b> arrow buttons simultaneously.</p> <p>b. The Temperature Display will show the letters “CO”, then begin flashing the <b>current display temperature value</b>.</p> </div> </div> <p><b>Note:</b> If an arrow key is not pressed for 5 seconds, the display will cease flashing, and store the last displayed value as the new current chamber temperature value.</p>	<p>SET TEMPERATURE</p>  <p>Calibration Mode</p> <p>SET TEMPERATURE</p>  <p>Current Display Value</p>
<div style="display: flex; align-items: center;">  <div style="margin-left: 20px;"> <p>6. Use the <b>Up or Down</b> arrows to adjust the current display temperature value until it matches the reference device temperature reading.</p> </div> </div>	<p>Reference Device</p>  <p>SET TEMPERATURE</p>  <p>Corrected Display Value</p>
<p>7. After correcting the display value, wait 5 seconds.</p> <div style="display: flex; align-items: center;">  <div style="margin-left: 10px;"> <p>Wait 5 Seconds</p> </div> <div style="margin-left: 20px;"> <p>a. The Temperature Display will cease flashing, store the correction, and resume showing the current temperature.</p> <p>b. The incubator will begin heating or cooling in order to reach Day set point with the corrected display value.</p> </div> </div>	<p>SET TEMPERATURE</p>  <p>Cooling to Set Point</p>

*Procedure continued on next page*


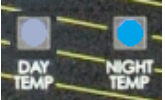





# MAINTENANCE (CONTINUED)

Daytime Temperature Calibration (Continued)	
<p>8. Allow the incubator to sit for one 1 hour undisturbed to stabilize <b>after it has achieved the set point</b> with the corrected display.</p>  <p>Wait 1 Hour</p> <p>a. Failure to wait until the incubation chamber is fully stabilized will result in an inaccurate reading.</p>	<p>SET TEMPERATURE</p>  <p>Stabilized</p>
<p>9. Compare the reference device reading with the incubator temperature display again.</p> <p>a. If the reference device and the incubator temperature display readings are the same or the difference falls within the range of your protocol, <b>the incubator is now calibrated for the Day Mode temperature.</b> Advance to Step 11 to begin the Night Mode temperature calibration.</p> <p>b. See the next step if the readings fail to match or fall outside of your protocol range.</p>	<p>Reference Device</p>  <p>SET TEMPERATURE</p> 
<p>10. If a difference still falls outside the acceptable range of your protocol, repeat steps 4 – 9 up to two (2) more times.</p> <p>a. Three calibration attempts may be required to successfully calibrate units that are more than <math>\pm 2^{\circ}\text{C}</math> out of calibration.</p> <p>b. If the Day Mode temperature readings of the incubator and the reference device still fall outside your protocol after three calibration attempts, contact your distributor or <b>Technical Support</b> for assistance.</p>	<p>Reference Device</p>  <p>SET TEMPERATURE</p> 

*Procedure continued on next page*










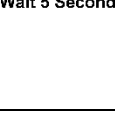



# MAINTENANCE (CONTINUED)

## Part 2: Calibrate the Nighttime Temperature

Nighttime Temperature Calibration	
<p>11. Place the incubator in Night Mode.</p>  <ol style="list-style-type: none"> <li>Press and hold the Mode button for 5 seconds.</li> <li>The Day Temp indicator will extinguish.</li> <li>The blue Night Temp indicator will illuminate.</li> </ol>	<p><b>Night Mode</b></p> 
<p>12. Wait 1 hour to allow the temperature to stabilize <b>after the Temperature display achieves the Nighttime set point.</b></p> <ol style="list-style-type: none"> <li>The reference device temperature measurement should not register a chamber fluctuation of <math>\pm 0.1^{\circ}\text{C}</math> or greater for at least 1 hour in order for the chamber to be considered stabilized.</li> </ol>	 <p>Wait 1 Hour</p>
<p>13. Once the temperature has stabilized, compare the reference device and the incubator display temperature readings.</p> <ol style="list-style-type: none"> <li>If the readings are the same or the difference between the two falls within the acceptable range of your protocol, <b>the incubator is calibrated for Night Mode temperature.</b> The Calibration procedure is now finished.</li> <li>If a difference falls outside of your protocol range, advance to the next step.</li> </ol>	<p>Reference Device</p>  <p>SET TEMPERATURE</p> 
<p>14. A display calibration adjustment must be entered to match the display Night Mode to the reference device. See next step.</p>	<p>Reference Device</p>  <p>SET TEMPERATURE</p> 





Procedure continued on next page

# MAINTENANCE (CONTINUED)

Nighttime Temperature Calibration (Continued)	
<p>15. Place the unit in its temperature calibration mode.</p> <div style="display: flex; align-items: center;">  <div style="margin-left: 10px;"> <p>a. Press and hold both the <b>UP and DOWN</b> arrow buttons simultaneously for approximately 5 seconds.</p> </div> </div> <div style="display: flex; align-items: center;">  <div style="margin-left: 10px;"> <p>b. The Temperature Display will show the letters “CO”, then begin flashing the <b>current display temperature value</b>.</p> </div> </div> <p><b>Note:</b> If an arrow key is not pressed for five seconds, the display will cease flashing, and store the last displayed value as the new current chamber Night Mode temperature value</p>	<p><b>SET TEMPERATURE</b></p>  <p>Calibration Mode</p> <p><b>SET TEMPERATURE</b></p>  <p>Current Display Value</p>
<div style="display: flex; align-items: center;">  <div style="margin-left: 10px;"> <p>16. Use the <b>Up</b> or <b>Down</b> arrows to adjust the current display temperature value until it matches the reference device temperature reading.</p> </div> </div> <div style="display: flex; align-items: center;">  </div>	<p>Reference Device</p>  <p><b>SET TEMPERATURE</b></p>  <p>Corrected Display</p>
<p>17. After correcting for the offset, wait 5 seconds.</p> <div style="display: flex; align-items: center;">  <div style="margin-left: 10px;"> <p>a. The incubator Temperature Display will cease flashing, store the correction, and resume showing the current temperature.</p> </div> </div> <p>Wait 5 Seconds</p> <div style="display: flex; align-items: center;">  <div style="margin-left: 10px;"> <p>b. The incubator will now begin heating or cooling in order to reach your set point with the corrected display value.</p> </div> </div>	<p><b>SET TEMPERATURE</b></p>  <p>Cooling to Set Point</p>
<p>18. Allow the incubator to operate undisturbed for at least 1 hour to stabilize after it has achieved the set point <b>with the corrected display value</b>.</p> <div style="display: flex; align-items: center;">  <div style="margin-left: 10px;"> <p>a. Failure to wait until the incubation chamber is fully stabilized will result in an inaccurate reading.</p> </div> </div> <p>Wait 1 Hour</p>	<p><b>SET TEMPERATURE</b></p>  <p>Stabilized</p>

Procedure continued on next page

# MAINTENANCE (CONTINUED)

Nighttime Temperature Calibration (Continued)	
<p>19. Compare the reference device reading with the incubator temperature display again.</p> <ul style="list-style-type: none"><li>a. If the reference device and the incubator temperature display readings are the same or the difference falls within the range of your protocol, <b>the incubator is calibrated for Night Mode temperature</b>. The Calibration procedure is now correct.</li><li>b. See the next step if the readings still fail to match or fall outside of your protocol range.</li></ul>	<p>Reference Device</p>  <p>SET TEMPERATURE</p> 
<p>20. If a difference still falls outside the acceptable range of your protocol, repeat steps 13 – 19 up to two (2) more times.</p> <ul style="list-style-type: none"><li>a. Three calibration attempts may be required to successfully calibrate units that are more than <math>\pm 2^{\circ}\text{C}</math> out of calibration.</li><li>b. If the temperature readings of the incubator and the reference device still fall outside your protocol after three calibration attempts, contact your incubator distributor or <b>Technical Support</b> for assistance.</li></ul>	<p>Reference Device</p>  <p>SET TEMPERATURE</p> 

*End of procedure*

# UNIT SPECIFICATIONS

These incubators are 100 - 120 voltage units. Please refer to the incubator data plate to verify its electrical specifications.

Technical data specified applies to units with standard equipment at an ambient temperature of 25°C and a voltage fluctuation of ±10%. The temperatures specified are determined in accordance to factory standard following DIN 12880 respecting the recommended wall clearances of 10% of the height, width, and depth of the inner chamber. All indications are average values, typical for units produced in the series. We reserve the right to alter technical specifications at all times.

## WEIGHT

Model	Shipping	Net Weight
SRI6PF	204lbs / 92.5kg	163lbs / 74kg
SRI20PF	363lbs / 164.7kg	295lbs / 133.8kg

## DIMENSIONS

### In inches

Model	Exterior W x D x H	Interior W x D x H
SRI6PF	30 x 31.5 x 33.5 in	25.5 x 24.0 x 18.5 in
SRI20PF	30 x 31.5 x 69.5 in	25.5 x 24.0 x 54.5 in

### In Centimeters

Model	Exterior W x D x H	Interior W x D x H
SRI6PF	76.2 x 80.01 x 85.09 cm	64.8 x 61.0 x 47.1 cm
SRI20PF	76.20 x 80.01 x 176.53 cm	64.77 x 60.96 x 138.43 cm

## CAPACITY

Model	Cubic Feet	Liter
SRI6PF	6.55	185.53
SRI20PF	19.30	546.57

# UNIT SPECIFICATIONS (CONTINUED)

## *SHELF CAPACITY BY WEIGHT*

<b>Model</b>	<b>Per Shelf</b>	<b>Total</b>
SRI6PF	75lbs / 34kg	150lbs / 34kg
SRI20PF	75lbs / 34kg	375lbs / 170kg

## *TEMPERATURE*











<b>Model</b>	<b>Temp Range</b>	<b>Uniformity</b>	<b>Stability</b>
SRI6PF	15° to 40°C	±0.5° @ 20°C	±0.1°C @ 20°C
SRI20PF	15° to 40°C	±0.5° @ 20°C	±0.1°C @ 20°C

## *POWER*

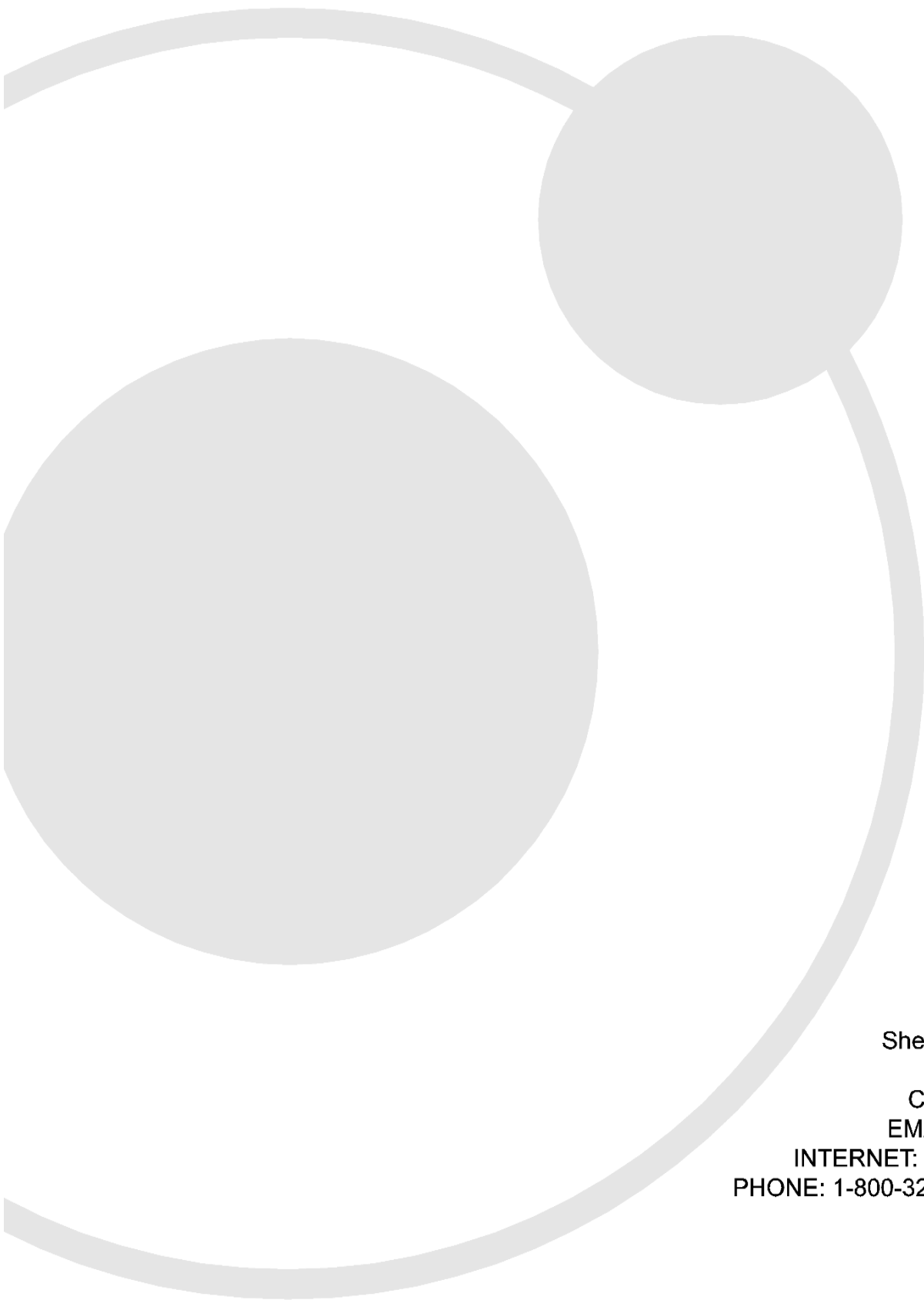
<b>Model</b>	<b>Voltage</b>	<b>Amperage</b>	<b>Frequency</b>
SRI6PF	100 – 120VAC	4.0 Amps	50/60 Hz
SRI20PF	100 – 120VAC	5.5 Amps	50/60 Hz



# PARTS LIST

Description	Part Number	Description	Part Number
Access Port Stopper	 7750517	Humidity Reservoir Pan and Tubing (Optional Accessory)	 9900708
Feet, Adjustable Glide	 2700506	Power Cord, 125V, 15 Amp, 8 foot (2.5m) NEMA 5-15P	 1800510
Fuse 6.3A	 3300515	Shelf (1)	 6800525
Gasket, Magnetic Door SRI6PF (29 inches X 26 inches)	 3450743	Static Shelf Mount (1 Bracket)	 5220942
Gasket, Magnetic Door SRI20PF (29 inches X 62 inches)	 3450732	Sliding Shelf Mounting Kit (2 Brackets)	 9490560

If you have the Part Number for an item, you may order the item directly from Sheldon Manufacturing by calling (503) 646-3000 Ext. 3. If you are uncertain that you have the correct Part Number or if you need that specific part, please contact Sheldon Technical Support for help at 1-800-322-4897 or (503) 640-3000 extension 4. Please have the **model number** and **serial number** of the unit ready, as Tech Support will need this information to match your unit with its correct part.



Sheldon Manufacturing Inc.  
P.O. Box 627  
Cornelius, Oregon 97113  
EMAIL: [tech@Shellab.com](mailto:tech@Shellab.com)  
INTERNET: <http://www.Shellab.com>  
PHONE: 1-800-322-4897 (503) 640-3000  
FAX: (503) 640-1366

