

DESICCATORS+



Low-Cost Solutions for High Technology



Acrylic SmartDesiccator™ No. 1911-41A
(shelves optional)



Miniaturized LED monitors humidity and displays set point

Reduces nitrogen cost by 78%!



Seconds to install and program!



304 Stainless Steel SmartDesiccator™
22"W x 20.75"D x 16.625"H

Cat. # S/Each
1911-02C 3,051.00

BUY ONLINE! Items priced in blue usually ship in 1-3 days.

SMARTDESICCATOR™ BENCHTOP STORAGE SYSTEM

- Automates dry benchtop storage to eliminate moisture-related degradation and optimize yields
- First-of-its-kind gas controller system conserves nitrogen
- Fully integrated turnkey system takes 30 seconds to install

Terra Universal's SmartDesiccator™ maximizes yields of sensitive materials by automatically maintaining a user-determined humidity set point.

Its quick-response feedback system continuously monitors the cabinet's relative humidity level and activates a purge of dry nitrogen only when needed. The system thus economizes on gas consumption and minimizes the possibility of overpressures that can stress cabinet seals. Comparison testing reveals that the SmartDesiccator™ maintains a low relative humidity level using only 22% of the nitrogen required by a flowmeter-based system of the identical size (see below).

Stainless steel doors restrict the door from flexing or bending, thereby preventing the cracks and fatigue that occur in all-plastic cabinets. A specially designed lift latch eliminates hinge and door damage caused by the strain of twisting and turning conventional latch systems. The SmartDesiccator™ also incorporates a one-piece, nonadhesive, nonoutgassing gasket specially formulated to retain sealing integrity in extreme low humidity. Because it won't sag or migrate, it extends the service life of the cabinet.

Prices include the humidity control module, sensor, and Automatic RB Valve. Systems are available in stainless steel, acrylic or transparent static-dissipative PVC, which helps control static charges and the particles they attract.

Automatic RB® (Relief/Bleed) Valve Cat. # 1600-60B S/Each 94.00

Plastic SmartDesiccators™ (See above for stainless steel)						Shelf					
Chambers	Overall Dimensions (WxDxH)	Materials				Perforated Stainless Steel		Non-Perforated Stainless Steel		Acrylic*	
		Acrylic*		Dissipative PVC		Cat. #	S/Each	Cat. #	S/Each	Cat. #	S/Each
1	12" x 12" x 13.25"	1911-15D	1,311.00	1911-21D	1,411.00	1935-02	89.00	1935-05	93.00	1935-01	27.00
1	17.12" x 18" x 13.25"	1911-45A	1,537.00	1911-46A	1,952.00	1976-02	133.00	1976-05	133.00	1976-01	44.00
1	22.62" x 18" x 13.25"	1911-43A	1,722.00	1911-44A	2,222.00	1977-02	149.00	1977-05	149.00	1977-01	50.00
1	22.62" x 24" x 13.25"	1911-41A	1,827.00	1911-42A	2,416.00	1978-02	159.00	1978-05	159.00	1978-01	59.00
2	17.12" x 18" x 25.25"	1911-16D	1,935.00	1911-22D	2,629.00	1976-02	133.00	1976-05	133.00	1976-01	44.00
2	22.62" x 18" x 25.25"	1911-17D	2,080.00	1911-23D	2,845.00	1977-02	149.00	1977-05	149.00	1977-01	50.00
2	22.62" x 24" x 25.25"	1911-18D	2,314.00	1911-24D	3,297.00	1978-02	159.00	1978-05	159.00	1978-01	59.00

* Acrylic is damaged by alcohol and other cleaning agents.

Smart Performance — and Big Savings!

Testing demonstrates the cost benefit of the SmartDesiccator's automated nitrogen control system.

The test below was conducted on a 24"W x 18"D x 24"H desiccator equipped with a flowmeter and then with a SmartDesiccator™ control system, under the following conditions:

- Ambient Humidity: 60% RH
- Temperature: 70°F
- RH Setpoint: 10% RH
- Test Period: Achieve setpoint and then maintain it for 24 hours
- Chamber Access: Door opened once every 30 minutes; remained open for one minute

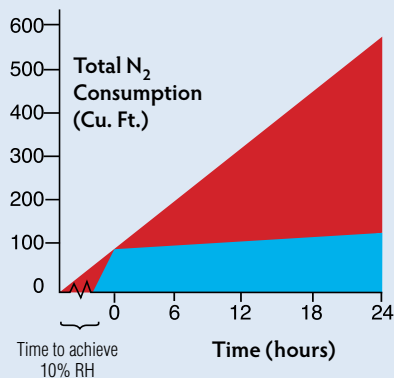

Desiccator with 0 - 20 SCFH flowmeter (red area on chart)

- To achieve setpoint: 85 cubic feet (requires over 4 hours @ 20 CFH). Note: setpoint measured with a hygrometer, since this set up does not monitor humidity level.
- Maintain for 24 hrs: 480 cubic feet (24 x 20)
- Total N₂ Consumed: 565 cubic feet

SmartDesiccator™ (blue area on chart)

- To achieve setpoint: 85 cubic feet (required 30 minutes @ 170 cubic/hour on high flow)
- Maintain for 24 hrs: 40 cubic feet
- Total N₂ Consumed: 125 cubic feet**

SmartDesiccator™ uses 22% of nitrogen consumed by standard cabinet—a 78% saving!

ADJUST-A-SHELF™ DESICCATOR STORAGE SYSTEM

(please turn the page for ordering information)

Humidity Control Systems

SmartDesiccator™—page 2

NitroPlex™—see page 10

Dual Purge & NitroWatch™—page 14

*Dual Purge™ System

- Maintains positive internal pressure
- Provides low and high purge to save N₂
- Blocks out contamination and moisture
- Activates alarm if door is left open

*NitroWatch®

- Displays RH level inside desiccator
- Operates with Dual Purge™ System to maintain a low humidity level automatically

Grounding terminals ground entire cabinet with a single connection

* Sensor Switches provide reliable control of high- and low-flow purging—rated for over 10 million operations!

Plenum Chamber minimizes backfill, ensures homogeneous positive pressure

* Automatic RB® Valve

- Reduced size allows mounting in each chamber for improved performance
- Bleeds off excess gas
- Makes cabinet rupture-proof
- Calibrated to maintain the required positive pressure

* One-piece nonadhesive gaskets eliminate flaking, shrinking, slippage; ensure tight seal and prevent sagging

Chrome-Plated Wire Racks support slide-out stainless steel trays and shelves

* Stainless steel conductive shelf electrically grounded to protect stored parts and devices against electrostatic discharge

* Grounded LiftLatch™ discharges the operator before stored components are damaged; eliminates stress on hinge (all-stainless steel models available)

* Stands available in stainless steel, with and without casters

* Stainless Steel door frame improves sealing, extends service life of cabinet



Tamper-proof hinge available



on selected models

* Options—refer to separate catalog listings for full descriptions



Blue Prices: items usually ship in 1–3 days. Order: 714-578-6000



Vol. 4 No. 15

TWO CHAMBERS PER TIER

Standing Adjust-A-Shelf™ Desiccators with Interchangeable Shelving

Shelving (including shields and trays) of models listed on these pages can be used interchangeably in any desiccator chamber with the same nominal dimensions.

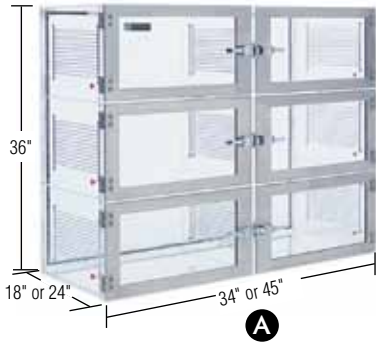

Manufactured by
Terra Universal

Terra will custom manufacture a turnkey system to meet your requirements. Call for a quotation.

BUY ONLINE! Items priced in blue usually ship in 1-3 days.

Pass-Through models available for dual-side access—see TerraUniversal.com

Specifications				Adjust-A-Shelf™ Desiccators						Corresponding Acrylic Shelf		304 Stainless Steel Door Frames	
TYPE	Overall Dimensions (W ^o x D ^o x H ^t)	No. of Doors	I.D. of Shelves (useable area) (W ^o x D ^o)	Static Dissipative* PVC		Clear Acrylic***		Amber Acrylic***		Includes Bow Guard**		Select appropriate quantity for your desiccator	
				Cat. #	\$/Each	Cat. #	\$/Each	Cat. #	\$/Each	Cat. #	\$/Each	Cat. #	\$/Each
A	45 x 24 x 36	Two Chambers Per Tier	19.875 x 21	3950-00A	5,710.00	3950-30A	3,078.00	3950-60A	3,332.00	1978-01	59.00	2200-30A	160.00
	34 x 18 x 36		14.25 x 14.5	3950-01A	4,431.00	3950-31A	2,736.00	3950-61A	2,902.00	1976-01	44.00	2200-31A	140.00
	45 x 18 x 36		19.875 x 14.5	3950-02A	5,130.00	3950-32A	2,916.00	3950-62A	3,155.00	1977-01	50.00	2200-30A	160.00
	45 x 24 x 48		19.875 x 21	3950-03A	7,361.00	3950-33A	3,803.00	3950-63A	4,108.00	1978-01	59.00	2200-30A	160.00
	34 x 18 x 48		14.25 x 14.5	3950-04A	5,444.00	3950-34A	3,077.00	3950-64A	3,307.00	1976-01	44.00	2200-31A	140.00
	45 x 18 x 48		19.875 x 14.5	3950-05A	6,956.00	3950-35A	3,470.00	3950-65A	3,740.00	1977-01	50.00	2200-30A	160.00
B	45 x 24 x 60	Two Chambers Per Tier	19.875 x 21	3950-06A	8,979.00	3950-36A	4,353.00	3950-66A	4,777.00	1978-01	59.00	2200-30A	160.00
	34 x 18 x 60		14.75 x 14.5	3950-07A	7,134.00	3950-37A	3,816.00	3950-67A	4,191.00	1976-01	44.00	2200-31A	140.00
	45 x 18 x 60		19.875 x 14.5	3950-08A	8,207.00	3950-38A	4,161.00	3950-68A	4,566.00	1977-01	50.00	2200-30A	160.00
D	22.625 x 24 x 24	One Chamber Per Tier	19.875 x 21	3950-09A	2,319.00	3950-39A	1,336.00	3950-69A	1,368.00	1978-01	59.00	2200-60A	152.00
	17.125 x 18 x 24		14.25 x 14.5	3950-10A	1,669.00	3950-40A	976.00	3950-70A	972.00	1976-01	44.00	2200-61A	133.00
	22.125 x 18 x 24		19.875 x 14.5	3950-11A	1,995.00	3950-41A	1,158.00	3950-71A	1,223.00	1977-01	50.00	2200-60A	152.00
	22.625 x 24 x 36		19.875 x 21	3950-12A	3,345.00	3950-42A	1,892.00	3950-72A	2,048.00	1978-01	59.00	2200-60A	152.00
E	17.125 x 18 x 36	One Chamber Per Tier	14.25 x 14.5	3950-13A	2,363.00	3950-43A	1,644.00	3950-73A	1,776.00	1976-01	44.00	2200-61A	133.00
	22.625 x 18 x 36		19.875 x 14.5	3950-14A	2,941.00	3950-44A	1,771.00	3950-74A	1,915.00	1977-01	50.00	2200-60A	152.00
	22.625 x 24 x 48		19.875 x 21	3950-15A	4,331.00	3950-45A	2,204.00	3950-75A	2,401.00	1978-01	59.00	2200-60A	152.00
F	17.125 x 18 x 48	One Chamber Per Tier	14.75 x 14.5	3950-16A	3,133.00	3950-46A	1,834.00	3950-76A	1,978.00	1976-01	44.00	2200-61A	133.00
	22.625 x 18 x 48		19.875 x 14.5	3950-17A	3,812.00	3950-47A	2,003.00	3950-77A	2,185.00	1977-01	50.00	2200-60A	152.00
	22.625 x 24 x 60		19.875 x 21	3950-18A	5,320.00	3950-48A	2,777.00	3950-78A	2,975.00	1978-01	59.00	2200-60A	152.00
	17.125 x 18 x 60		14.75 x 14.5	3950-19A	3,846.00	3950-49A	2,217.00	3950-79A	2,394.00	1976-01	44.00	2200-61A	133.00
G	22.625 x 18 x 60	One Chamber Per Tier	19.875 x 14.5	3950-20A	4,716.00	3950-50A	2,453.00	3950-80A	2,651.00	1977-01	50.00	2200-60A	152.00
	12 x 12 x 12		9.75 x 9.25	3950-21A	587.00	3950-51A	472.00	3950-81A	494.00	1935-01	27.00	2200-14A	85.00

* Constructed of transparent static-dissipative PVC; removable back wall made of nondissipative material. **For use in acrylic cabinets. Select stainless steel shelves for use with static-dissipative PVC cabinets. *** Acrylic is damaged by alcohol and other cleaning agents.



Better Doors — Long-Lasting Cabinets!

Doors are typically the only desiccator component to show signs of wear. These improvements safeguard your investment in clean, dry storage!

LiftLatches™ — Standard on all models, these noncontaminating, durable lifting latches operate without straining hinges. Upgrade to all-stainless steel models to minimize contamination. (See pg. 14).

Stainless Steel Door Frames — Lend strength and rigidity to plastic doors!

One-Piece, Nonadhesive Gaskets — Standard on all models with stainless steel frames, these durable gaskets are mechanically attached to eliminate adhesives.

ONE CHAMBER PER TIER

QuickQuote Planner
quickly configures a system to your specifications: www.TerraUniversal.com

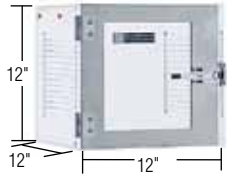

H

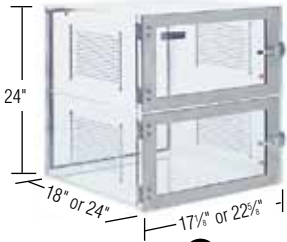

D



E



F

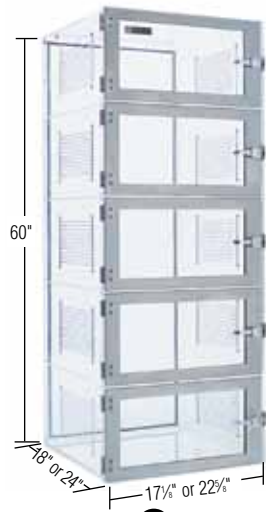

G

BUY ONLINE! Items priced in blue usually ship in 1-3 days.

Corresponding 304 Stainless Steel Shelves**					Corresponding Stands (leveling feet included) (see casters information at right)			Other Options (see page 14)	
Perforated Shelf	Non-Perforated Tray	Non-Perforated Shelf	Non-Perforated Shield	Price (Includes Installation)	Stainless Steel			S/Each	Cat. #
					3" High	12" High	3" & 12" High		
Cat. #	Cat. #	Cat. #	Cat. #	S/Each	Cat. #	Cat. #	S/Each		
1978-02	1978-04	1978-05	1978-06	159.00	1740-92	1740-56	621.00		
1976-02	1976-04	1976-05	1976-06	133.00	1740-94	1740-60	587.00		
1977-02	1977-04	1977-05	1977-06	149.00	1740-96	1740-64	605.00		
1978-02	1978-04	1978-05	1978-06	159.00	1740-92	1740-56	621.00		
1976-02	1976-04	1976-05	1976-06	133.00	1740-94	1740-60	587.00		
1977-02	1977-04	1977-05	1977-06	149.00	1740-96	1740-64	605.00		
1978-02	1978-04	1978-05	1978-06	159.00	1740-92	1740-56	621.00		
1976-02	1976-04	1976-05	1976-06	133.00	1740-94	1740-60	587.00		
1977-02	1977-04	1977-05	1977-06	149.00	1740-96	1740-64	605.00		
1978-02	1978-04	1978-05	1978-06	159.00	1740-92	1740-56	621.00		
1976-02	1976-04	1976-05	1976-06	133.00	1740-94	1740-60	587.00		
1977-02	1977-04	1977-05	1977-06	149.00	1740-96	1740-64	605.00		
1978-02	1978-04	1978-05	1978-06	159.00	1740-44	1740-80	417.00		
1976-02	1976-04	1976-05	1976-06	133.00	1740-48	1601-10	354.00		
1977-02	1977-04	1977-05	1977-06	149.00	1740-52	1740-88	387.00		
1978-02	1978-04	1978-05	1978-06	159.00	1740-44	1740-80	417.00		
1976-02	1976-04	1976-05	1976-06	133.00	1740-48	1601-10	354.00		
1977-02	1977-04	1977-05	1977-06	149.00	1740-52	1740-88	387.00		
1978-02	1978-04	1978-05	1978-06	159.00	1740-44	1740-80	417.00		
1976-02	1976-04	1976-05	1976-06	133.00	1740-48	1601-10	354.00		
1977-02	1977-04	1977-05	1977-06	149.00	1740-52	1740-88	387.00		
1978-02	1978-04	1978-05	1978-06	159.00	1740-44	1740-80	417.00		
1976-02	1976-04	1976-05	1976-06	133.00	1740-48	1601-10	354.00		
1977-02	1977-04	1977-05	1977-06	149.00	1740-52	1740-88	387.00		
1978-02	1978-04	1978-05	1978-06	159.00	1740-44	1740-80	417.00		
1976-02	1976-04	1976-05	1976-06	133.00	1740-48	1601-10	354.00		
1977-02	1977-04	1977-05	1977-06	149.00	1740-52	1740-88	387.00		
1935-02	1935-04	1935-05	1935-06	89.00	—	1605-09	338.00		

** Price for a shelf, shield, or tray of a given size is the same. All stainless steel shelves are electropolished and individually poly bagged and sealed to prevent surface contamination.

Critical Requirement?
Materials
Make all the Difference!



Plastics are permeable to moisture. Water vapor can penetrate the molecular structure of plastic, and even a constant, high flow of nitrogen may not keep it away from moisture-sensitive components in very low relative humidity applications.

For this reason, Terra recommends desiccators made of stainless steel—a much more effective moisture barrier—for critical relative humidity requirements < 10%RH (see page 8).

1606-61	1,798.00
1600-49	70.00
1600-60B	99.00
9500-00A	954.00
9500-02A	568.00
1700-44	246.00

Dual Purge™ System
 Dual Purge™ Sensor Switches (one/desiccator door required)
 Automatic RB™ Valve
 NitroWatch™
 NitroWatch™ Sensor (one/desiccator required)
 Casters (heavy-duty, low-profile, set of 4, including 2 with brakes)

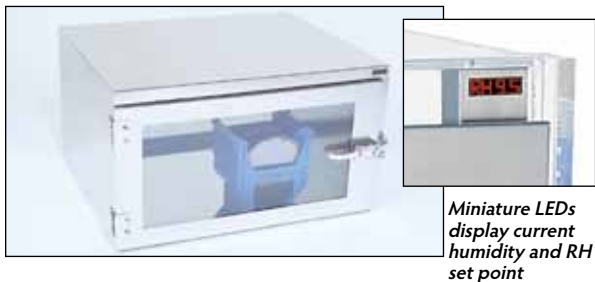

Smart Desiccator™ —
Saves up to 78% of nitrogen costs!

See page 2 for the SmartDesiccator™, Terra's automated storage environment that incorporates a humidity control system.

Miniature LEDs display current humidity and RH set point



RH/Temperature Data Logger.
Get a complete record of storage conditions—see page 7



Blue Prices: items usually ship in 1-3 days. Order: 714-578-6000



MADE in the U.S.A.

Vol. 4 No. 15

VALULINE™ DESICCATORS

Value Without Compromise!

- Low-cost system provides a controlled flow of nitrogen to prevent moisture-related degradation of stored materials
- Rigid cabinet construction includes rear plenum chamber, for uniform gas distribution, and reinforced doors
- Chrome-plated wire racks allow shelf adjustment to accommodate varying part sizes (order plastic or stainless steel shelves separately)
- Parts standardization simplifies upgrades and replacements
- Turnkey systems include flowmeter and Automatic RB™ (Relief/Bleed) Valve — just connect to N₂ source and you're ready for operation

Designed for Clean, Durable Operation

Designed for purging with nitrogen to achieve low-humidity conditions, each model includes a perforated rear plenum wall that strengthens the cabinet and allows gas to enter all chambers uniformly.

Doors feature reinforcement ribs to ensure a better seal against closed-cell gasketing. The expansion latches eliminate internal scraping caused by rotary-style latches; the closing mechanism is positioned outside the chamber to keep stored materials clean.

Select among five standard sizes. **Acrylic models** provide strength and full visibility of stored parts but do not stand up to repeated wipe-down with strong cleaning agents (including alcohol). They also accumulate static surface charges that can lead to electro-static discharge.

Static-Dissipative PVC models eliminate these problems. Durable, molecularly embedded dissipative layers ensure safe removal of surface charges, protecting against both ESD and particle attractions. They also offer wide chemical resistance and are safe for use with alcohol.



Component Standardization — a Terra Value Advantage!

Break a latch? Not a problem. Terra desiccator components, from doors to racks to hinges, are standardized and stamped with a part number for easy identification. If any component is damaged, simply call for a replacement.

Terra stocks hardware for models placed in service over a decade ago. You tell us the serial number of your Terra product, no matter how old, and chances are we can replace or upgrade worn parts.



Compression Gaskets
Eliminate scraping, contaminants, and wrist strain produced by twist-style latches.



Chrome-plated Racks and Hinges
Select Adjust-A-Shelf Desiccators for all-stainless steel hardware.



Automatic RB® (Relief/Bleed) Valve
Relieves pressure to extend life of gaskets and hinges; functions as a check valve to prevent air influx.



In Stock!

Order by 10:00am PST for same-day shipping.



Standard components: flowmeter, chrome-plated hinges and racks, relief/bleed valve, grounding terminal (included on static-dissipative PVC models)



Five chamber configurations, in clear acrylic or tinted static-dissipative PVC, which eliminates static charges that attract particles.

ValuLine™ Desiccator*

Specifications			Clear Acrylic**		Static-Dissipative PVC	
No of Chambers	Nominal Dimensions W" x D" x H" (mm)	Nominal Inside Dimensions W" x D" (mm)	Cat. #	S/Each	Cat. #	S/Each
1	12 x 12 x 12 (305 x 305 x 305)	9.75 x 9.25 (248 x 235)	3949-00	290.00	3949-10	401.00
2	17.12 x 18 x 24 (432 x 457 x 610)	14.25 x 14.5 (362 x 368)	3949-01	690.00	3949-11	1,123.00
3	17.12 x 18 x 36 (432 x 457 x 914)	14.25 x 14.5 (362 x 368)	3949-02	1,120.00	3949-12	1,587.00
4	17.12 x 18 x 48 (432 x 457 x 1219)	14.25 x 14.5 (362 x 368)	3949-03	1,192.00	3949-13	2,036.00
5	17.12 x 18 x 60 (432 x 457 x 1524)	14.25 x 14.5 (362 x 368)	3949-04	1,441.00	3949-14	2,500.00

* Order desired shelves and stands separately (see below).

** Acrylic is damaged by repeated contact with strong cleaning agents, including alcohol

Powder-Coated Stand

Raises cabinets 4". Noncontaminating nylon leveling feet included. Select optional casters below. Recommended for cabinets with more than three chambers to allow floor positioning.

	Cat. #	S/Each
Stand	1740-32	342.00
Casters (set of 4)	1700-44	246.00

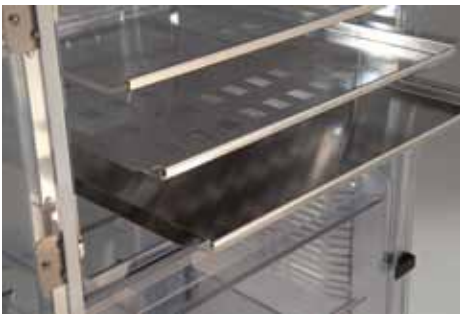

Shelves and Trays

Material	For 1-chamber ValuLine™ Desiccators		All Other ValuLine™ Desiccators	
	Cat. #	S/Each	Cat. #	S/Each
Reinforced Acrylic Shelf	1935-01	27.00	1976-01	44.00
Perforated 304 SS Shelf	1935-02	89.00	1976-02	133.00
Solid 304 SS Shelf	1935-05	93.00	1976-05	133.00
Solid 304 SS Tray	1935-04	93.00	1976-04	133.00



Low-cost temperature & humidity monitoring

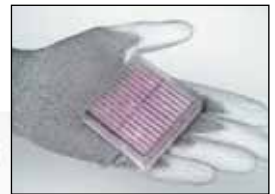

RH/Temperature Data Logger

USB device provides a convenient record of storage conditions! Records data at selected intervals. Download to computer to display in several formats.

Cat. #	S/Each
9500-10	205.00

Temperature/Humidity Gauge

Ideal for monitoring humidity. Includes installation.

Cat. #	S/Each
5401-15	143.00

Kleer-Vue Sorbent Boxes

An alternative to nitrogen purging, these desiccant units contain indicating silica gel that turns from blue to pink as silica gel absorbs moisture. To regenerate, simply dry in a conventional or microwave oven. 2.125" x 2.125" x .8". Twin pack contains two boxes.

	Cat. #	S/Each
Sorbent Boxes	2010-75	28.00
Silica Gel (20 lb. can)	1900-02	185.00



Blue Prices: items usually ship in 1-3 days. Order: 714-578-6000



Vol. 4 No. 15



A Model shown is 1610-32A



B Model shown is 1678-10A



C Shown with optional gas controls and castered stand.



D Gas controls optional. No. 1991-56A

Series 100-300 STAINLESS STEEL DESICCATORS



Terra manufactures several lines of stainless steel desiccators, for applications ranging from benchtop storage to multiplexed humidity control. All feature the one-piece gaskets and LiftLatches for superior service life and sealing performance.

Note: Series 100 and 300 desiccators include shelf racks on a standard basis. Racks must be specified for other models if shelves are required.

A/B. Series 100 Benchtop Stainless Steel Desiccator

Air-tight seals and all-stainless steel construction maintain a low-humidity storage environment to keep parts clean and dry. Inlet/outlet ports allow nitrogen purging (see page 14 for ordering information on optional nitrogen controllers). Transparent static-dissipative PVC windows protect against static and particle build-ups.

Electropolishing Available!

C. Series 200 Double-Wall Stainless Steel Desiccators

Smooth-profile stainless steel design ensures a static-safe environment that won't shed or accumulate particles. Built-in gas plumbing and Automatic Relief/Bleed Valve in each chamber allow easy, safe connection to nitrogen or clean dry air purge line.

Shelves	Cat. #	\$/Each
Perforated	1610-35	158.00
Solid	1679-45	158.00

Stands	Cat. #	\$/Each
4" High	9606-29	338.00
12" High	9606-32	338.00

D/E. Series 300 Stainless Steel Desiccator

Provides all the humidity control features of the Series 100 and 200 models above, but features easy-open double doors for fast, easy access to the whole cabinet.

BUY ONLINE! Items priced in blue usually ship in 1-3 days.



E No. 1991-58

Series 100 Stainless Steel Desiccator: Subtract 2" from OD to get ID

Outside Dimensions (W"xD"xH")	Tempered Class Windows		Dissipative PVC Windows		Corresponding Shelves*		
	Cat. #	\$/Each	Cat. #	\$/Each	Perforated	Non-Perforated	\$/Each
12 x 10.75 x 12	1678-00A	1,121.00	1610-34A	1,161.00	1610-40	1678-05	96.00
12.25 x 16 x 12.25	1690-00A	1,300.00	1610-91A	1,281.00	1610-92	1610-93	104.00
16 x 13 x 16	1678-10A	1,541.00	1610-33A	1,526.00	1610-41	1679-01	150.00
22 x 21.625 x 16	1679-06A	1,976.00	1610-32A	1,961.00	1610-42	1679-45	150.00

* Individually polybagged after electropolishing to prevent surface contamination.

Series 200 Stainless Steel Adjust-A-Shelf™ Desiccators

No. of Chambers	Chamber Dimensions (W"xD"xH")	Overall Dimensions (W"xD"xH")	Stainless Steel		Electropolished Stainless Steel	
			Cat. #	\$/Each	Cat. #	\$/Each
1	20 x 20 x 14	23.5 x 22.5 x 16.5	9606-20A	2,826.00	9606-00A	3,153.00
2	20 x 20 x 14	23.5 x 22.5 x 33.5	9606-21A	5,868.00	9606-01A	6,045.00
3	20 x 20 x 14	23.5 x 22.5 x 50	9606-22A	9,106.00	9606-02A	9,127.00

Series 300 Stainless Steel Desiccators

	72"H x 36"W x 18"D		36"H x 36"W x 18"D		Shelf*		Stand**	
	Cat. #	\$/Each	Cat. #	\$/Each	Cat. #	\$/Each	Cat. #	\$/Each
304 Stainless Steel	1991-56A	12,699.00	1991-58	6,361.00	1991-51	292.00	1991-54A	544.00
Electropolished SS	1991-57A	13,729.00	1991-59	7,342.00	1991-53	379.00	1991-55A	611.00

* Includes perforations along one edge to permit gas circulation. Comes with mounting clips.

** Includes leveling feet; raises cabinet 4" off floor.



Series 400

STAINLESS STEEL DESICCATORS

The Series 400 Stainless Steel Desiccator provides the optimal clean, low-humidity environment for sensitive parts.

Available in many chamber configurations, it includes front and rear static-dissipative PVC viewing windows for full visibility of stored contents. Static-dissipative PVC helps control static charges and the particles they attract.

All models feature a plenum chamber that ensures uniform distribution of nitrogen purge gas.

NitroPlex™-Ready!

Terra fabricates these desiccators for use with the NitroPlex™ humidity control system, the most advanced nitrogen purge controller available. Equipped with the NitroPlex™, these systems automatically regulate a nitrogen purge in order to maintain any relative humidity set point you require—down to 0% RH. See page 10 for more information.



Temperature/Humidity Gauge

Includes installation on any specified desiccator cabinet.

Cat. # **5401-15** S/Each **143.00**

Heavy-Duty Cleanroom Casters

Set of Four **1700-43** **590.00**



NitroPlex™ display modules indicate chamber % RH (optional)

Model shown: No. 1609-11A (configured for double-side access), with optional NitroPlex™ humidity control system and stainless steel casters.

Series 400 Stainless Steel Desiccators – For use with NitroPlex™ Control System, add NP to part number.

Type (See below)	No. of Chambers	Nominal Dimensions* (W ^o x D ^o x H ^o)	Single-Side Access				Double-Side Access			
			304 Stainless Steel		Electropolished 304 Stainless Steel		304 Stainless Steel		Electropolished 304 Stainless Steel	
			Cat. #	S/Each	Cat. #	S/Each	Cat. #	S/Each	Cat. #	S/Each
A	2	25 x 20.75 x 33.75	1609-01A	3,670.00	1609-01AEP	3,933.00	1609-07A	4,327.00	1609-07AEP	4,399.00
	3	25 x 20.75 x 50.62	1609-02A	5,686.00	1609-02AEP	6,083.00	1609-08A	6,381.00	1609-08AEP	6,778.00
	4	25 x 20.75 x 67.50	1609-03A	7,933.00	1609-03AEP	8,595.00	1609-09A	8,860.00	1609-09AEP	9,521.00
B	4	47 x 20.75 x 33.75	1609-04A	7,134.00	1609-04AEP	7,796.00	1609-10A	8,061.00	1609-10AEP	8,590.00
	6	47 x 20.75 x 50.62	1609-05A	11,092.00	1609-05AEP	11,886.00	1609-11A	12,484.00	1609-11AEP	13,278.00
	8	47 x 20.75 x 67.50	1609-06A	15,691.00	1609-06AEP	16,222.00	1609-12A	17,546.00	1609-12AEP	18,870.00

** Excludes hardware. Stands raise cabinets an additional 4" (with leveling feet) or 7" (with casters).

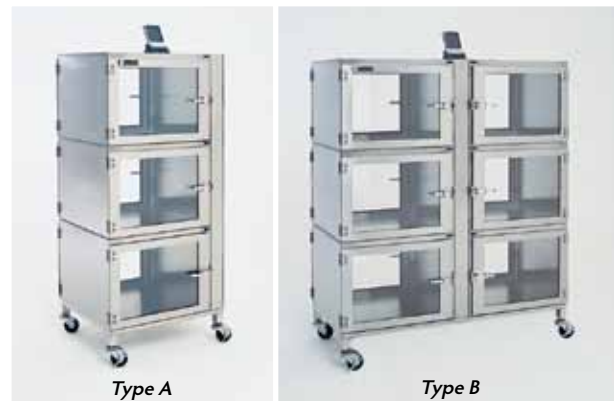

Type A

Type B

Both models shown with optional NitroPlex™ System and casters.

System Options

Accessory	Stainless Steel		Electropolished Stainless Steel	
	Cat. #	S/Each	Cat. #	S/Each
Shelf Rack**	—	—	1609-13EP	35.00
Perforated Shelf	1609-14	131.00	1609-14EP	171.00
Solid Shelf	1609-15	131.00	1609-15EP	171.00
Stands (with levelers)				
4"H – Type "A"	1609-16	291.00	1609-16EP	423.00
4"H – Type "B"	1609-18	444.00	1609-18EP	599.00
12"H – Type "A"	1609-17	291.00	1609-17EP	423.00
12"H – Type "B"	1609-19	444.00	1609-19EP	599.00

** Required with selection of shelves. Order two per chamber.

Heavy-Duty Casters

Includes set of 4, two with locking brakes.

Cat. # **1700-43** S/Set of 4 **590.00**



Blue Prices: items usually ship in 1–3 days. Order: 714-578-6000



Vol. 4 No. 15

NITROPLEX™ HUMIDITY CONTROL SYSTEM



Sensor/Display Modules
(one/chamber). Allow
multiplexed humidity control

*Cuts Nitrogen Costs,
Increases Efficiency!
See page 11 for more
information.*

Model shown: No. 3950-36NP, with ten (10) control modules (No. 1911-31A), stainless steel door frames, and stand.

- Increases desiccator efficiency up to 400% to minimize nitrogen waste and moisture exposure
- Senses and displays relative humidity in each desiccator chamber independently for more efficient, cost-effective moisture control
- Cuts nitrogen expenses by over 75%
- Prevents moisture and contamination migration from one chamber to another
- Lets you specify a different humidity set point for each chamber
- Automatically delivers a high-flow nitrogen purge only to the chamber where it's needed, and only as long as it's needed to restore RH set point
- Ergonomic design allows easy viewing, eliminates chamber lip for easier parts removal
- Can be integrated into almost any Terra desiccator line

**For Critical Requirements—
When every Minute of
Exposure Matters!**



*Miniature LEDs display
current humidity and
RH set point*

Increased Efficiency Lowers Recovery Time, Increases Yields

The NitroPlex™ system provides state-of-the-art automated humidity control to guarantee the integrity of stored components.

Each microprocessor-based multiplexed sensor/display module, one installed in each chamber, enhances desiccator performance and economizes on nitrogen expenses. It contains a miniaturized moisture sensor that reads the internal humidity level within $\pm 2\%$ of full scale. The LED readout displays this value or the programmable set point for that chamber.

When the humidity climbs above the set point in any chamber, the NitroPlex automatically directs a high-flow purge of clean, dry nitrogen only to the chamber where it is needed, and only for as long as necessary to bring the humidity back below the set point value.

Specifications

Dimensions:	1.5"W x 2.75"D x 1.5"H; increases height of affected chamber by 1.25" (Humidity Module)
Housing Material:	Stainless steel (chamber humidity modules)
Power Requirement:	110VAC, 50/60Hz or 220VAC, 50Hz (universal power supply)
Display:	5-digit LED
Display Resolution:	$\pm 0.1\%$ RH
Sensor Accuracy:	$\pm 2\%$ RH @ 20°C
Measuring Range:	0 - 100% RH
Calibration:	None required. A calibration mode is included for applications that require calibration to an NIST-traceable instrument.

QuickQuote Planner
quickly configures a system to your specifications: www.TerraUniversal.com



**Stainless Steel Systems Available!
See page 9.**

NITROPLEX™ ORDERING INFORMATION

You can convert any of Terra's standard desiccators into a NitroPlex™ System simply by adding an "NP" to the desiccator part number. Then, order one NitroPlex™ module (Cat. No. 1911-31A) for each desiccator chamber.

Example: Cat. No. 3950-36NP is a NitroPlex™ version of Terra's standard Adjust-A-Shelf desiccator. To complete the order, specify (10) chamber sensor/display modules.

NitroPlex™ Module Cat. # **1911-31C** S/Each **1,097.00**
Includes humidity sensor, 5-digit LED display, Automatic RB® Valve, and gas plumbing. Order one per chamber.

Many Other NitroPlex™ Systems Available!
See page 9.

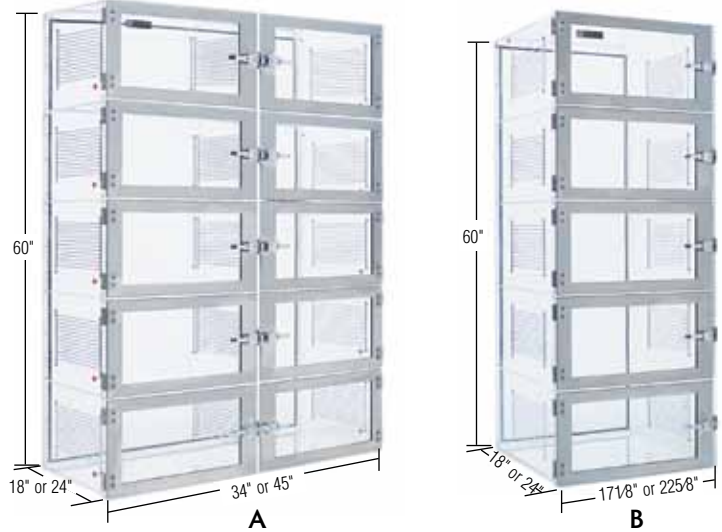

Type	Specifications		NitroPlex™ Desiccators				304 Stainless Steel Door Frames		Corresp. Stainless Steel Shelves		Corresp. Stands (leveling feet incl.)	
			Static Dissipative PVC		Clear Acrylic		Select appropriate quantity for your desiccator		Perforated Shelf		Stainless Steel 4" High	
	Overall Dim. (W" x D" x H")		Cat. #	S/Each	Cat. #	S/Each	Cat. #	S/Each	Cat. #	S/Each	Cat. #	S/Each
A	45 x 24 x 60	Two chambers per tier	3950-06ANP	8,979.00	3950-36ANP	4,353.00	2200-30A	160.00	—	—	1740-92	621.00
	34 x 18 x 60		3950-07ANP	7,134.00	3950-37ANP	3,889.00	2200-31A	140.00	1976-02	133.00	1740-94	587.00
	45 x 18 x 60		3950-08ANP	8,207.00	3950-38ANP	4,234.00	2200-30A	160.00	1977-02	149.00	1740-96	605.00
B	22.625 x 24 x 60	One chamber per tier	3950-18ANP	5,320.00	3950-48ANP	2,777.00	2200-60A	152.00	1978-02	159.00	1740-44	417.00
	17.125 x 18 x 60		3950-19ANP	3,846.00	3950-49ANP	2,217.00	2200-61A	133.00	1976-02	133.00	1740-48	354.00
	22.625 x 18 x 60		3950-20ANP	4,685.00	3950-50ANP	2,453.00	2200-60A	152.00	1977-02	149.00	1740-52	387.00

Recovery Time Comparison — The NitroPlex™ Advantage

Almost any desiccator maintains a low-RH storage environment under ideal conditions. Problems begin when someone opens a door.

Immediately, moisture-laden air backfills the cabinet. The measure of an efficient humidity control system is how quickly the cabinet can remove moisture and recover the initial humidity set point.

In a large desiccator with a flowmeter and a single bleed valve, this recovery can take up to an hour. If, during this recovery period, another door is opened, the process begins again. Moisture may remain present in the storage enclosure during the entire duration of a working shift—negating your investment in desiccator storage and slashing your product yields.

Terra's Dual Purge™ and NitroWatch™ systems improve system recovery time by initiating a high-flow purge when a door opens or humidity creeps above a set point threshold. This variable purging speeds up moisture removal, but recovery can still take up to 40 minutes if only one bleed valve is present (see Figure 1).

Simply by installing Terra's Automatic RB™ (Relief/Bleed) Valve in each chamber, you can cut both the system recovery time and the nitrogen consumption in half (see Figure 2). This configuration minimizes moisture migration—water vapor is purged out of the chamber it enters.

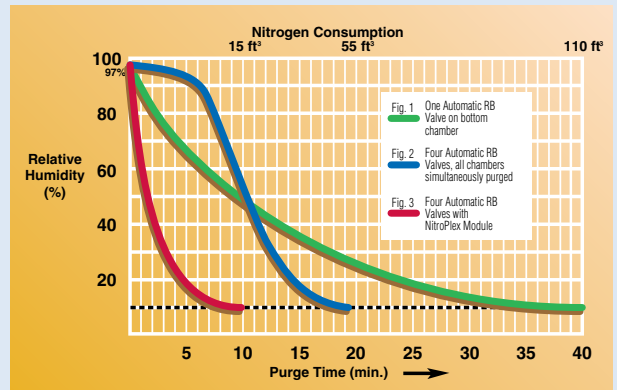

Nitrogen Consumption Recovery Time

- Fig. 1: 110 ft³
- Fig. 2: 55 ft³ (100% improvement)
- Fig. 3: 15 ft³ nearly 300% improvement)
- Fig. 1: 40 minutes
- Fig. 2: 20 minutes (100% improvement)
- Fig. 3: 10 minutes (400% improvement)

For optimal efficiency, however, a desiccator requires chamber-by-chamber humidity sensing and purge control. Only Terra's NitroPlex™ system delivers this purge efficiency (see Figure 3). A NitroPlex™ desiccator typically saves up to 77% in nitrogen cost. More importantly, it cuts system recovery time by 400%, ensuring dry storage under real-world operating conditions.



Blue Prices: items usually ship in 1–3 days. Order: 714-578-6000



Vol. 4 No. 15

WAFER BOX DESICCATOR

These desiccators are designed specifically to maximize storage efficiency of standard lot boxes used for 200mm and 300mm wafers.

They feature the same advanced technology features of standard Terra desiccators, including the most efficient sealing techniques available. For optimal performance, select the optional stainless steel door frames, which extend cabinet life and improve sealing performance through the use of one-piece, non-adhesive gaskets.



BUY ONLINE! Items priced in blue usually ship in 1-3 days.

For 200mm Wafers						
No. Of Chambers	Capacity*	Acrylic**		Static-Dissipative PVC		
		Cat. #	S/Each	Cat. #	S/Each	
10	40	9130-20A	5,051.00	9130-24A	9,572.00	
5	20	9130-21A	3,056.00	9130-25A	5,832.00	
For 300mm Wafers						
8	16	9130-22A	4,029.00	9120-26A	7,293.00	
4	8	9130-23A	2,320.00	9130-27A	4,031.00	

* 200 capacities based on Empac No. TR-08A (four boxes per chamber). 300 capacities based on Empac No. SX300 01 (two boxes per chamber)

** Acrylic is damaged by alcohol and other cleaning agents.

Optional Features Cabinet Style (No. of Chambers)	Door Frames		Stands* Stainless Steel	
	Cat. #	S/Each	Cat. #	S/Each
10	9130-28A	159.00	9130-30	354.00
5	9130-34A	159.00	9130-31	276.00
8	9130-29A	161.00	9130-32	348.00
4	9130-35A	161.00	9130-33	267.00

*Includes levelers. Raises cabinet 4".



No. 9130-23A (for 300 mm wafers), shown with optional stainless steel door frames.

No. 9130-21A (for 200mm wafer carriers), shown with optional stainless steel door frames, humidity controllers, and stand.

PORTABLE DESICCATORS

- A convenient, contamination-free, economical carrying container for moisture-sensitive devices
- Stackable design permits space-saving storage
- Optional quick-connect and Automatic RB[®] (Relief/Bleed) Valve allow nitrogen purge for a particle-free, low-moisture environment
- Static-dissipative PVC option ensures ESD-safety, eliminates particle attraction to ensure clean surfaces

See ordering chart below



Micro-Desiccators

Perfect for small parts storage. Inlet/outlet ports available for nitrogen purging, or use with desiccant (see page 13).

	Cat. #	Acrylic		Static-Dissipative PVC	
		S/Each	Cat. #	S/Each	
9 x 11 x 8.5	4950-06	444.00	4950-08	705.00	
10 x 16 x 9.5	4950-09	576.00	4950-11	857.00	



RH/Temperature Data Logger. Get a complete record of storage conditions—see page 7

All models shown with standard access doors. Select stainless steel door frames for extended service.

TYPE	Specifications Outside Dimensions (W"xD"xH")	Portable Desiccators						Accessories	
		Clear Acrylic*		Static Dissipative PVC		Amber Acrylic*		304 Stainless Steel Door Frames	
		Cat. #	S/Each	Cat. #	S/Each	Cat. #	S/Each	Cat. #	S/Each
A	12 x 12 x 12	9302-17	323.00	9302-20	537.00	9302-24	378.00	2200-14A	85.00
B	10 x 10.5 x 8.5	9302-00	274.00	9302-21	388.00	9302-25	317.00	2200-51A	53.00
C	12 x 6 x 6	9302-18	266.00	9302-22	378.00	9302-26	309.00	2200-52A	45.00
D	20 x 6 x 6	9302-19	308.00	9302-23	442.00	9302-27	358.00	2200-53A	75.00

* Acrylic is damaged by alcohol and other cleaning agents.

Optional Features:

Quick Connect Fitting

Installed, requires RB Valve.

Cat. #	S/Each
1601-06	32.00

Automatic RB[®] Valve

Installed; see page 14.

Cat. #	S/Each
1600-60B	99.00





A Polyethylene Frame



B Stainless Steel Frame (shown with optional shelves)



Cushioned ride for optimal product protection of wafers and other delicate parts.

DESI CART™ LOW HUMIDITY TRANSPORT CARTS



These mobile storage carts transport components from one location to another while maintaining critical low-humidity and low-particle conditions.

Each houses a hermetically sealed desiccator storage chamber, which maintains clean, dry storage conditions during parts transport. Desiccators feature opposing access doors for pass-through convenience, and every door is equipped with a LiftLatch™.

Quick connect/disconnect fittings (optional) enable you to purge the system with nitrogen while it is stationary. Reinforced door construction and gasketing provide air-tight seals that maintain a clean, dry storage environment while the DesiCart is in motion.

Note: Models below feature chrome-plated racks and opposing doors for pass-through access.

RH/Temperature Data Logger

USB device logs data at selected intervals for download/display.

Cat. # **9500-10** \$/Each **205.00**

Quick Connect/Disconnect Fitting

(installed; requires RB Valve) Cat. # **1601-06** \$/Each **32.00**

Automatic RB® (Relief/Bleed) Valve

(Required for safe gas purging) Cat. # **1600-60B** \$/Each **99.00**

A. Polyethylene Frame			Ordering Information				Corresponding Shelves				
Overall H x W x L (inches)	Shelving W x D (inches)	Doors (8) H x W (inches)	with Acrylic* Desiccator		with Static-Dissipative PVC		Acrylic*		304 Stainless Steel		
			Cat. #	\$/Each	Cat. #	\$/Each	Cat. #	\$/Each	Shield	Cat. #	\$/Each
33.25 x 27 x 39.5	15 x 22	9 x 15	4002-50B	2,820.00	4002-51B	4,164.00	4002-52	67.00	Tray	4002-54	185.00
									Shelf	4002-55	185.00

* Acrylic is damaged by alcohol and other cleaning agents.

B. Stainless Steel Frame			Ordering Information				Corresponding Shelves				
Overall H x W x L (inches)	Shelving W x D (inches)	Doors (8) H x W (inches)	with Acrylic* Desiccator		with Static-Dissipative PVC		Acrylic*		304 Stainless Steel		
			Cat. #	\$/Each	Cat. #	\$/Each	Cat. #	\$/Each	Shield	Cat. #	\$/Each
38 x 24 x 36	13.75 x 20	20.5 x 15.75	4001-90B	3,563.00	4001-91B	4,753.00	4001-92	61.00	Tray	4001-97	183.00
									Shelf	4001-95	174.00

* Acrylic is damaged by alcohol and other cleaning agents.

C. Wafer Box DesiCart™

This DesiCart™ ensures clean, dry, secure transport of delicate wafers. Its 6"-diameter spring-loaded casters provide a cushioned ride, and ultra-clean materials of construction, including electropolished stainless steel shelves, ensure surfaces that won't slough or outgas.

Overall dimensions: 50.88"W x 26.25"D x 38"H (including hardware). Holds up to 12 200mm wafer boxes.*

Ordering Information

Enclosure Material Cat. # \$/Each
 Acrylic **4002-48B** **6,309.00**
 Static-Dissipative PVC **4002-49B** **7,411.00**

*Based on Empak model TR-08A. Custom sizing is available for other carrier sizes.



Blue Prices: items usually ship in 1-3 days. Order: 714-578-6000



MADE
in the
U.S.A.

Vol. 4 No. 15

ENVIRONMENTAL CONTROL SYSTEMS



Miniaturized humidity displays



Actual Size: 7/16" x 7/16" x 1.5"

A. NitroPlex™ Multiplexed Humidity Controller

See page 10

B. Desiccator Dual Purge™ System

Provides variable-flow gas purge to block out moisture and contaminants. Switches to high-flow purge to compensate for pressure drop-out or rising humidity levels. Requires RB valve.

	Cat. #	\$/Each
Dual Purge System (110/220VAC, 50/60Hz)	1606-61	1,798.00
Sensor Switch (order one per desiccator door)	1600-49	70.00

C. NitroWatch™ Humidity Controller

Operates together with the Dual Purge System to maintain a low humidity set point. Also displays current RH level.

	Cat. #	\$/Each
Control Unit (draws power from Dual Purge)	9500-00A	954.00
Humidity Sensor (order one per cabinet)	9500-02A	568.00

D. Automatic RB® (Relief/Bleed) Valve

Automatically relieves pressure build-ups to ensure safe operating conditions with Terra's gas control systems. One valve recommended per storage chamber.

	Cat. #	\$/Each
Model Shown	1600-60B	99.00
RB Valve with Exhaust Fitting (Allows connection of .25" exhaust tubing)	1600-60A	113.00

E. Flowmeters

For static control of nitrogen purge in small benchtop desiccators. Note: Because flowmeters cannot vary nitrogen flow in response to operating conditions, they increase nitrogen expenses and are not recommended for large cabinets.

Flow Range	Cat. #	\$/Each
1 - 10 SCFH	1600-31	118.00
2 - 20 SCFH	1600-32	118.00

F. Desiccator Ionizing Modules

These low-voltage ionizers minimize EMI/RFI and safety hazards. Emitters, mounted in a 304 stainless steel housing in the desiccator plenum chamber, direct balanced streams of positive and negative ions to safely neutralize static charges.

G. Electropolished Stainless Steel LiftLatches

Terra's LiftLatches™ eliminate rotary motion that strains hinges and gaskets. Standard cabinets include chrome-plated latches.

	Cat. #	\$/Each
304 EP Stainless Steel (316 SS available)		
Upgrade Models*	1603-63-2	49.00
Retrofit Models**	1603-40-2	184.00

* Upgrades must be ordered together with the associated desiccator cabinet.

** Use the same mounting holes and hardware as standard latches for fast, easy installation.

H. Humex 2™ Humidifier

Provides inline humidification of nitrogen or other process gas being fed into a desiccator. Quick vaporization module eliminates moisture sputtering.

	Cat. #	\$/Each
Humex 2™ 110VAC, 50/60 Hz	9081-02	2,478.00
Humex 2™ Humidity Sensor	9500-02A	568.00



B



C



E



F



F



G



H

DESICCATORS by Bel-Art

For creating optimal dry, dust-free and sometimes air-free storage of moisture sensitive products, compact and portable Secador® 1.0 and 2.0 desiccators are an excellent choice for applications in the pharmaceutical, industrial, and electronic components packaging industries. The patented seal design provides excellent moisture protection, and the one latch loops allow securing with a lock or tamper evident seal. Door-mounted hygrometer allows convenient tracking of RH. Manually operated and monitored models are made from Durastar® co-polyester plastic material that blocks 99% of UV light from penetrating the interior of the cabinet. These desiccators resist stains, chemicals and fine cracks. Interchangeable units have built-in carrying handles and stack up to three units high. Moisture is absorbed inside the unit by silica, activated charcoal and/or gel beads.

A. Secador® 1.0 Desiccator Clear with Blue End Caps

Dimensions: 13.4"W x 16.3"D x 8.4"H. Ideal for storing moisture sensitive items and samples. Includes one removable perforated shelf.

Cat. #	S/Each
1538-09	173.00

B. Secador® 1.0 Desiccator Amber

Amber color reduces light penetration by more than 50%. Dimensions: 13.4"W x 16.3"D x 8.4"H. Ideal for storing light sensitive items and samples. Includes one removable perforated shelf.

Cat. #	S/Each
1538-11	195.00

C. Secador® 2.0 Desiccator Clear

Dimensions: 13.4"W x 16.3"D x 12.4"H. Ideal for storing moisture sensitive items and samples. Includes two adjustable perforated shelves.

Cat. #	S/Each
3618-54	346.00

D. Secador® 2.0 Desiccator Amber

Amber color reduces light penetration by more than 50%. Dimensions: 13.4"W x 16.3"D x 12.4"H. Ideal for storing light sensitive items and samples. Includes two adjustable perforated shelves.

Cat. #	S/Each
3618-56	363.00

E. Disposable Desiccant Cartridges 60mm

Ideal for use with Secador 1.0 or 2.0 desiccators, these desiccant cartridges reduce moisture and the silica gel beads turn pink when saturated with moisture. The transparent polystyrene dish allows silica gel examination. Order includes 6 disposable desiccant cartridges per pack 2.375" (60 mm) diameter. Cartridges are non-toxic, non-corrosive and inert.

Cat. #	S/Each
1538-14	45.00

F. Techni-Dome® Vacuum Desiccator

The Techni-Dome® Vacuum Desiccator offers up to four times more volume, 65 liters (4,000 cu. in.) than most other large benchtop units—enough for items up to 45cm (18") tall or wide. Polycarbonate construction is chemical resistant and easy to clean. Safely support vacuum level to 29" Hg (737 mm) at room temperature for 24 hours. Includes stopcock with Teflon® plug and two polypropylene shelves. Size: 22" diameter.

Cat. #	S/Each
3308-11	355.00

G. More Vacuum Desiccators

See page 19

Custom designs to your specifications!



A



B



C



D



E



F



G

No. 3305-80



Blue Prices: items usually ship in 1-3 days. Order: 714-578-6000



Vol. 4 No. 15

PROCESS GAS GENERATORS and DRYERS

Terra's gas generators and gas dryers provide several ways to produce a dry, particle-free environment inside glove boxes, desiccators, and other enclosures.

Membrane separation systems operate with no moving parts and require almost no maintenance. The Nitrogen Generator uses this technology to provide a reliable source of clean, dry nitrogen.

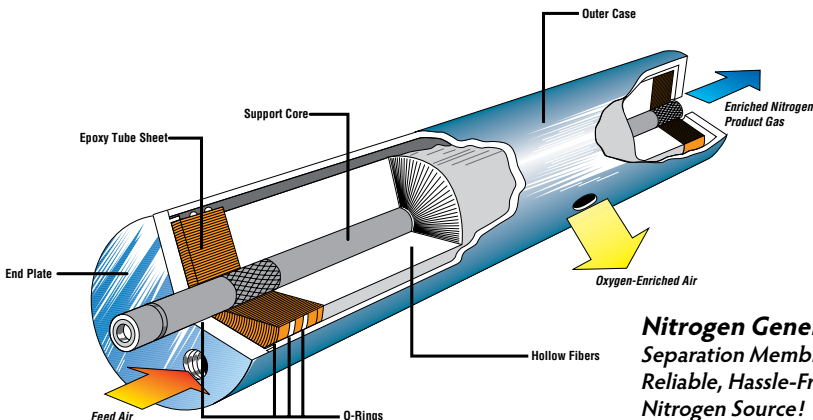

Nitrogen Generators

Purity vs. Flow Rates (@100 PSI inlet feed, 72°F*)

Model	99%	98%	97%
No. 2700-12A	7.4 CFH	10.2 CFH	12.5 CFH
No. 2700-11A	49.0 CFH	65.0 CFH	75.0 CFH
No. 2700-09A	126.0 CFH	180.0 CFH	223.0CFH

* Higher flow rates can be achieved with higher feed temperature (see Terra's process gas heater, No. 4320-00).



A Nitrogen Generator

BUY ONLINE! Items priced in blue usually ship in 1-3 days.



B Dryex 80™



C Dryex 10™

Comparative Guide to Terra Gas Dryers

Product	Design Type	Outlet Flow Capacity	Service Requirement	Prefilters Included	Overall Dimensions (WxDxH)	Recommended Application	Cat. #	\$/Each
A. Nitrogen Generator	Membrane	See performance chart	Air Compressor (#9505-47)	Yes (micro-fiber & coalescing)	18 x 18 x 81.25	Gloveboxes, desiccators & N ₂ based process equipment in labs where N ₂ is preferable to dry air	2700-09A	14,452.00
					24 x 12 x 49.25		2700-11A	6,344.00
					20 x 12 x 35.5		2700-12A	5,070.00
B. Dryex 80™ Gas Dryer	Membrane	420-900 SCFH	Air Compressor (#9505-43)	Yes (micro-fiber & coalescing)	24 x 12 x 49.25	Low-humidity applications (in gloveboxes or desiccators) where clean, dry air is acceptable	9082-00	4,954.00
C. Dryex 10™ Generator	Membrane	54-105 SCFH @ 100 PSIG	Air Compressor (#9505-43)	Yes (micro-fiber & coalescing)	16x 7.25 x 6.5	Ideal source of purged gas in moisture-sensitive storage and processing applications	9082-01	2,570.00

HIGH-CAPACITY NITROGEN GENERATOR

- Turnkey solution supplies high-volume of 99%+ pure nitrogen for laboratory or industrial applications*
- Compressor processes clean, dry air for nitrogen production
- Eliminates limitations of conventional nitrogen sources—gives you control of rate, purity and cost of nitrogen production
- Large nitrogen holding tank ensures a ready supply at all times
- Modular design allows easy accessibility of all components for required maintenance

Terra Universal's High-Capacity Nitrogen Generator includes both a high-volume rotary screw air compressor and Terra nitrogen* tanks/membranes for a complete system. Simply allow the holding tank to fill, and you've got 60 gallons of N₂ ready to use. Easily and quickly replenish as needed.

The product is designed to provide a continuous flow of 99%+ pure nitrogen without the expense and inconvenience associated with gas cylinders. To begin the nitrogen separation process, the compressed air passes through coalescing filters to remove residual water, oil and particles. The air then enters the hydrocarbon scrubber/filter to remove hydrocarbon vapors. The separation of nitrogen from other gases is the last step in the process; the filtered air enters the nitrogen generator membranes where nitrogen gas is partitioned and stored in a 60-gallon pressurized tank ready for use.



High Capacity Nitrogen Generator, 120VAC, No. 2701-32

Specifications

Nitrogen Purity:	99%+ (depending on inlet pressure)
Power Requirements (compressor):	208/230/460 VAC, 60Hz, 3-phase, prewired for 460V operation
Power Requirements (generator):	120VAC / 240VAC
Generator Max. Power:	4kW
Footprint:	90" x 72" (generator and compressor)
Maximum height:	96"
Generator Tank Capacity	N ₂ holding tank: 60 gal.; Compressed air storage: 200 gal.
Compressor pressure range	217 psig
Compressor Capacity	157 acfm
Compressor Motor Power	50 HP
Compressor Dimensions	78.375"L x 40.5"W x 67"H
Compressor Weight	2,458 lb

	Cat. #	S/Each
High-Capacity Nitrogen Generator 120 VAC	2701-32	\$43,000.00
240 VAC	2701-32-220	\$43,000.00

* See performance data at TerraUniversal.com for correlated flow.

A Reliable Nitrogen Source When You Need It!

Nitrogen's (N₂) inert properties make it a necessity for many industries, such as life science, semiconductor, aerospace, food, chemicals, and energy. It's widely used for drying, purging, cooling, and to create a protective barrier between sensitive parts and the damaging environment (i.e., oxygen). High-volume N₂ production is an effective process that eliminates limitations and higher cost of N₂ canisters.



High-capacity Rotary Screw Air Compressor

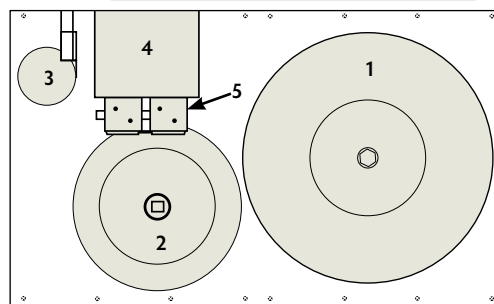

Component configuration inside nitrogen generator powder-coated steel cabinet

Nitrogen Generator System Components:

- 1 200-gallon air holding tank
- 2 60-gallon nitrogen holding tank
- 3 Hydrocarbon filter
- 4 Two (2) nitrogen membranes and one (1) exit filter
- 5 Coalescing pre-filters
6. High-volume rotary screw compressor



Blue Prices: items usually ship in 1-3 days. Order: 714-578-6000



Vol. 4 No. 15



Sure-Grip® EX Safety Can Storage Cabinets

Designed to meet OSHA and NFPA standards, these cabinets are sturdily constructed of all-welded, 18-gauge, double-walled steel with 1.5" of insulating air space for fire resistance. They include spill-slope safety shelves adjustable on 3" centers and dual vents with built-in arresters. All models shut and latch automatically when fusible links melt at 165°F (74°C) under fire conditions. Patented, concealed closing mechanism in self-close style maximizes available shelf space and minimizes risk of damage to the mechanism. Backed by a 10-year warranty.



Justrite Centura Safety Can, No. 2820-48
Many capacities, in polypropylene and stainless steel

Capacity (gal.)	Dimensions (W x D x H)	Approval Listing*	Doors/Type	Cat. #	S/Each
30	43" x 18" X 44"	FM, N, O	2 / manual	2800-00A	513.00
30	43" x 18" X 44"	FM, N, O, U	2 / self-closing	2820-00A	574.00
45	43" x 18" X 65"	FM, N, O	2 / manual	2820-02A	636.00
45	43" x 18" X 65"	FM, N, O, U	2 / self-closing	2820-03A	699.00
60	34" x 34" X 65"	FM, N, O	2 / manual	2820-05A	767.00
60	34" x 34" X 65"	FM, N, O, U	2 / self-closing	2820-06A	859.00

* See Approval Key



Corrosive Storage Cabinets

These steel cabinets feature a two-part enamel coating which has been tested successfully with widely used acids, caustics, and alkalines, such as hydrochloric acid 37%, sulfuric acid 33%, and sodium hydroxide. This surface will not allow absorption that could cause subsequent problems. The 22-gallon model is an Under-the-Counter Cabinet, with polypropylene-lined bottom and top, and a .75-inch tray top, which can completely contain a 5-pint spill. The other three models, which are floor-mounted, feature corrosive-resistant polyethylene trays, to contain spills, on the bottom and on the shelves.

Approval Key

FM Factory Mutual tested and approved
 N National Fire Protection Association (NFPA) code 30
 O Complies with OSHA regulations
 U Complies with Uniform Fire Code

Capacity (gal.)	Dimensions (W x D x H)	Approval Listing*	Doors/Type	Cat. #	S/Each
30	43" x 18" X 44"	FM, N, O	2 / manual	2820-09A	618.00
45	43" x 18" X 65"	FM, N, O	2 / manual	2820-10A	708.00
45	43" x 18" X 65"	FM, N, O, U	2 / self-closing	2820-11A	793.00
22	35" x 22" x 35"	FM, N, O	2 / manual	2820-12A	591.00

* See Approval Key

Enclosed Safety Shower

- Provides full-body shower and eye wash while protecting lab against water and chemical splashes
- Polypropylene enclosure resists most lab acids and corrosives
- Easy-parting transparent vinyl curtain allows fast, convenient access while shielding the external environment
- Immediate-response operation handles are easy to activate

Terra's safety shower combines easy, reliable operation with a fully enclosed design that enhances safety both inside and outside the shower area.

The polypropylene shell resists most laboratory acids and corrosives. By shielding the shower on three sides, it minimizes the chance of the water spray—or of harmful chemical splashes—affecting parts or personnel outside the shower. The 40-mil overlapping vinyl strip curtain on the front is easily parted for quick entry into the enclosure.

All eye rinser hardware is zinc-plated. The standard overhead nozzle height is 78" off the shower floor; the eye rinsers are positioned 42" off the floor. The shower comes complete with PVC plumbing that connects to your in-house water supply by means of a 1.25" ID pipe fitting. The sloping bottom feeds into a 2.5" drain line. Dimensions: 38"W x 41"D x 90"H. Complete specifications at TerraUniversal.com.



Cat. # **1530-50** S/Each **7,433.00**

See specifications/ordering chart below.

A. High-Capacity Chamber (see chart below)

Ideal for degassing large assemblies. Powder-coated steel chamber with 1"-thick aluminum door. Includes 1"-thick polycarbonate viewing window, piping, fittings and solenoid valve for convenient control (order pump and vacuum controller separately). 18"W x 48"L stainless steel shelf creates a convenient platform 4.5" above chamber floor.

Powder-Coated Steel Stand Cat. # S/Each
 Raises chamber shelf to 34.6" above floor level **3404-04 1,189.00**

B. Stainless Steel Chamber (see chart below)

Double-wall construction; includes 8" x 8" tempered glass viewing window and dual metering valves and 0-30" vacuum gauge.

C. Stainless Steel TrinosLine Medium Vacuum Chamber (see chart below)

Includes acrylic swing access door with left hinge and five vacuum ports to accommodate multiple vacuum lines: 2x KF16, 2x KF25, 1x KF40. Leak rate: 1×10^{-8} mbar l/s. High-vacuum models also available.

D. Full-View Acrylic Chamber (see chart below)

Made of 1/2"-thick cylindrical acrylic. Designed for continuous pump operation with safety relief valve.

E – J. Acrylic Chambers

See chart below.

Ideal for degassing and transporting small parts. Designed for continuous pump operation (order below).



Shown with optional stand, vacuum pump and controller



Vacuum Chamber Accessories

Metering Valves (installed) Cat. # S/Each
5235-09 168.00
 Two required for direct connection to pump, or one if connecting Vacuum Controller.

Vacuum Gauge (installed) Cat. # S/Each
5235-10 206.00
 Required if selected pump does not include metering kit.

Vacuum Controller

Recommended for all continuous vacuum applications. For Full Vacuum (to 29.9" Hg). Select appropriate Turnkey Connection Kit below.

120VAC, 60Hz Cat. # S/Each
1681-75 2,741.00
 220VAC, 50Hz **1681-75-220 2,741.00**

Connection Kit

Includes all connections, vacuum, solenoid, turnkey installation and testing charges.

For Type A–C Chambers Cat. # S/Each
5400-25 1,524.00
 For Type D–J Chambers **5400-24 1,524.00**

Complete line of pumps at TerraUniversal.com

Vacuum Chambers				Factory Tested*				
Type	Dimensions (W" x D" x H" excluding hardware)		Max. Vacuum	Cat. #	S/Each	Max. Vacuum	Cat. #	S/Each
	Outside	Inside						
A	49L x 30 dia.	48L x 26 dia.	29.9" Hg	3404-03	23,032.00	—	—	—
B	13 x 15 x 14	8 x 12 x 8	29.9" Hg	3404-00	3,261.00	—	—	—
C	Varies with flange size		20 x 20 x 20	5235-25	11,852.00	—	—	—
D	12"-dia. x 14.5	11"-dia. x 13.5	29.8" Hg	5235-08	2,309.00	—	—	—
E	17 x 11 x 12.5	14 x 8 x 9.5	27.0" Hg	5235-00A	2,202.00	29.9" Hg	5235-16	2,753.00
F	13 x 13 x 7.5	10.5 x 10.5 x 4.5	27.0" Hg	5235-01A	1,658.00	29.9" Hg	5235-17	2,065.00
G	9 x 9 x 9.5	6 x 6 x 6.5	27.0" Hg	5235-02A	1,439.00	29.9" Hg	5235-18	1,799.00
H	13 x 13 x 10.5	10 x 10 x 7.5	27.0" Hg	5235-03A	1,931.00	29.9" Hg	5235-19	2,414.00
I	17 x 17 x 13.5	15 x 15 x 11.5	27.0" Hg	5235-04A	2,276.00	29.9" Hg	5235-20	2,845.00
J	26.5 x 11 x 12.5	11 x 8 x 9.5	27.0" Hg	5235-06A	2,490.00	29.9" Hg	5235-21	3,113.00

* These models are individually factory leak tested and guaranteed to hold specified vacuum level for a minimum of 96 hours.



Blue Prices: items usually ship in 1–3 days. Order: 714-578-6000



Vol. 4 No. 15

Visit TerraUniversal.com for other configurations.

CLEANROOM and LAB STORAGE CABINETS



A No. 9130-03, with optional Filter Module and casters



B No. 9130-02, with optional Filter Module and Casters

A/B. Reticle Storage Cabinet for Vertical Storage

Open-structure shelves mounted on noncontaminating, low-friction runners provide full access. Each shelf contains three removable stainless steel trays. Order filter/blower separately.

Vertical Storage: Photomask/Reticle Cabinets

Stainless Steel		Electropolished Stainless Steel	
Cat. #	\$/Each	Cat. #	\$/Each
9130-00*	3,215.00	9130-02*	4,166.00
9130-01**	6,307.00	9130-03**	8,157.00

* 28.5"W x 25"D x 38"H (Capacity: 189 reticles 7" x 7" x .125"D)

** 28.5"W x 25"D x 62"H (Capacity: 378 reticles 7" x 7" x .125"D)

Filter/Blower Module (Includes HEPA filter).

	Cat. #	\$/Each
110VAC, 60Hz	9056-02	1,112.00
220VAC, 50Hz	9056-02-220	1,112.00

Panel Set

Includes two side panels, one rear panel, and hinged door.

Acrylic		Dissipative PVC	
Cat. #	\$/Each	Cat. #	\$/Each
9130-40*	342.00	9130-04*	652.00
9130-41**	647.00	9130-05**	1,301.00

* For 38"H models ** For 62"H models



Wire Shelf Cabinets – Stainless steel or laminate enclosures, available with HEPA filtration modules

C. Supplies Cabinet

Adjustable shelves hold garments, wipers, and other cleanroom supplies. See page 26 for ordering information.

D – F. Wafer Box Storage Cabinets

Electropolished stainless steel cabinet features adjustable shelves to accommodate many box sizes.

Wafer Storage Cabinets

Overall Dimensions	Cat. #	\$/Each
D. 47"W x 20"D x 67"H	9600-21**	13,073.00
E. 47"W x 26"D x 77"H	9600-22**	13,628.00
F. 47"W x 26"D x 41"H	9600-37*	5,423.00
G. 47"W x 26"D x 41"H	9600-38**	5,840.00

* Solid front door

** Dissipative PVC front windows



D No. 9600-21



E No. 9600-22



F No. 9600-37

GENERAL PURPOSE STORAGE CABINETS

- Economical storage cabinets are ideal for many laboratory, cleanroom and stockroom applications
- HEPA-filter/blower option provides a continuous downstream of particle-free air
- Select acrylic for full visibility and economy, or polypropylene for strength and chemical resistance

Clean, Durable, Economical

All cabinets feature double full-height access doors that require minimal clearance space. The durable hinges are spring-loaded and, together with gaskets, ensure a tight seal and a clean environment for stored materials.

For critical contamination-control requirements, select a model with an integral filter/blower module. This unit, mounted to the top of the cabinet, features a 740 CFM variable speed impeller that directs a continuous stream of HEPA-filtered air downward through the storage area (700 CFM under filter load).

All models with HEPA filter/blower modules feature shelf perforations to allow air distribution throughout the cabinet. They are available with either acrylic or static-dissipative PVC doors (dissipative PVC offers complete visibility in addition to dissipative characteristics and excellent chemical resistance).



Polypropylene Cabinet with Filter/Blower

Kleer-Vue Sorbent Boxes

An alternative to nitrogen purging, these desiccant units contain indicating silica gel that turns from blue to pink as silica gel absorbs moisture. To regenerate, simply dry in a conventional or microwave oven. 2.125" x 2.125" x .8". Twin pack contains two boxes.

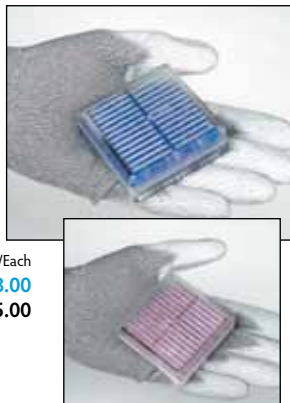

	Cat. #	S/Each
Sorbent Boxes	2010-75	28.00
Silica Gel (20 lb. can)	1900-02	185.00



Available with amber acrylic and germicidal lights

Acrylic Cabinet with Filter/Blower



Perforated shelves on models with filter/blowers optimize air flow.

General Purpose Storage Cabinets			Without Filter/Blower				With Filter/Blower			
Chamber Height*	No. of Tiers	Dimensions** (W" x D" x H)	Acrylic with Acrylic Doors***		Polypropylene with Dissipative PVC Doors		Acrylic with Acrylic Doors***		Polypropylene with Dissipative PVC Doors	
			Cat. #	S/Each	Cat. #	S/Each	Cat. #	S/Each	Cat. #	S/Each
12"	1	25.75 x 16.75 x 12.5	4102-00	315.00	4102-15	450.00	4102-29	1,165.00	4102-43	1,300.00
	2	25.75 x 16.75 x 24.75	4102-01	479.00	4102-16	684.00	4102-30	1,329.00	4102-44	1,534.00
	3	25.75 x 16.75 x 37	4102-02	658.00	4102-17	965.00	4102-31	1,508.00	4102-45	1,815.00
	4	25.75 x 16.75 x 49.25	4102-03	856.00	4102-18	1,302.00	4102-32	1,706.00	4102-46	2,152.00
	5	25.75 x 16.75 x 61.5	4102-04	1,074.00	4102-19	1,706.00	4102-33	1,924.00	4102-47	2,556.00
15"	1	25.75 x 16.75 x 15.5	4102-05	372.00	4102-20	497.00	4102-34	1,222.00	4102-48	1,347.00
	2	25.75 x 16.75 x 30.75	4102-06	556.00	4102-21	771.00	4102-35	1,406.00	4102-49	1,621.00
	3	25.75 x 16.75 x 46	4102-07	764.00	4102-22	1,114.00	4102-36	1,614.00	4102-50	1,964.00
	4	25.75 x 16.75 x 61.25	4102-08	999.00	4102-23	1,543.00	4102-37	1,849.00	4102-51	2,393.00
18"	1	25.75 x 16.75 x 18.5	4102-10	418.00	4102-24	543.00	4102-38	1,268.00	4102-52	1,393.00
	2	25.75 x 16.75 x 36.75	4102-11	624.00	4102-25	895.00	4102-39	1,474.00	4102-53	1,745.00
	3	25.75 x 16.75 x 55	4102-12	863.00	4102-26	1,370.00	4102-40	1,713.00	4102-54	2,220.00

* All internal dimensions are 24.25"W x 16.25"D x specified height.

** Filter/Blower adds 13" to specified cabinet height.

*** Acrylic is damaged by alcohol and other cleaning agents.

Stands

Powder-coated steel, includes nylon leveling feet. Raises cabinet 4".

Cat. #	S/Each
9010-94	222.00

Castors

Set of four, two with locking breaks.

Cat. #	S/Each
1700-44	246.00



Blue Prices: items usually ship in 1-3 days. Order: 714-578-6000



Vol. 4 No. 15



More sizes available –
www.TerraUniversal.com

A. Super Adjustable™ Wire Shelves

Just lift the release on each corner, adjust your shelf at precise 1"-increments, and clamp the release lever shut. In seconds, you can optimize your storage system to changing load requirements, with no tools, no wasted time, and no wasted space. For shelf grounding in static-sensitive applications, select conductive sleeves below.

BUY ONLINE! Items priced in blue usually ship in 1-3 days.

A. Super Adjustable Wire Shelves

Dimensions W x L (inches)	Chrome Plated		Stainless Steel	
	Cat. #	S/Each	Cat. #	S/Each
18 x 24	1701-75	45.00	2650-35	131.00
18 x 36	1701-76	46.00	2650-37	158.00
18 x 48	1701-77	55.00	2650-39	186.00
18 x 60	1701-78	63.00	2650-41	236.00
21 x 24	1697-24	52.00	2650-43	178.00
21 x 36	1701-79	54.00	2650-45	180.00
21 x 48	1701-80	62.00	2650-47	207.00
21 x 60	1697-28	72.00	2650-49	274.00
24 x 24	1701-81	56.00	2650-51	192.00
24 x 36	1701-82	58.00	2650-53	194.00
24 x 48	1701-83	67.00	2650-55	234.00
24 x 60	1701-84	79.00	2650-57	285.00

	Cat. #	S/Pkg.
Replacement Sleeves/Wedges (pack of 4)	1571-00	4.00
Conductive Sleeves (pack of 4)	1571-01	4.00



B. – C. Cleanroom Shelving with Split-Sleeve Assembly

This InterMetro shelving is fabricated of noncontaminating, cleanroom-compatible materials. Order aluminum split sleeve for shelf grounding.

B. Solid Shelves

Dimens. W x L (in)	Flat Stainless Steel		Chrome Plated		Stainless Steel	
	Cat. #	S/Each	Cat. #	S/Each	Cat. #	S/Each
18 x 24	1301-06	149.00	1300-35	41.00	1300-64	152.00
18 x 36	1301-08	158.00	1300-37	42.00	1300-66	154.00
18 x 48	1301-10	193.00	1300-39	51.00	1300-68	182.00
18 x 60	1301-11	235.00	1300-40	59.00	1300-69	232.00
21 x 24	1301-12	176.00	1300-42	48.00	1300-71	174.00
21 x 36	1301-14	179.00	1300-44	50.00	1300-73	176.00
21 x 48	1301-16	219.00	1300-46	58.00	1300-75	203.00
21 x 60	1301-17	264.00	1300-47	66.00	1300-76	270.00
24 x 24	1301-18	189.00	1300-49	50.00	1300-78	188.00
24 x 36	1301-20	194.00	1300-51	54.00	1300-80	190.00
24 x 48	1301-22	233.00	1300-53	63.00	1300-82	213.00
24 x 60	1301-23	284.00	1300-54	75.00	1300-83	281.00

C. Wire Shelves

Plastic Split Sleeve Assembly

Included with each shelf.

Aluminum Split Sleeve

For grounding type B/C shelves.

Cat. #	S/Pkg.
1303-70	8.00

SiteSelect™ Posts

Height (inches)	Stationary				*Mobile			
	Chrome Plated		Stainless Steel		Chrome Plated		Stainless Steel	
	Cat. #	S/Each	Cat. #	S/Each	Cat. #	S/Each	Cat. #	S/Each
14.5	1300-85	9.00	1300-91	20.00	—	—	—	—
34.5	1300-86	12.00	1300-92	31.00	1307-98	13.00	2650-01	32.00
54.5/62.5	1300-87	20.00	1300-93	30.00	1307-90	14.00	2650-02	31.00
62.5/62.5	1300-88	18.00	1300-94	39.00	1307-91	15.00	2650-30	34.00
74.6/25	1300-89	19.00	1300-95	43.00	1307-92	16.00	2650-03	46.00
86.6/25	1300-90	21.00	1300-96	52.00	1307-93	21.00	2650-04	54.00

* Make it mobile – Select the mobile post from chart above. Casters available at TerraUniversal.com



Wall-Mount Shelving

Order quantities indicated below to create an above-bench storage unit. Posts are 33.6"H and allow shelf adjustment. Metroseal 3 coating inhibits growth of bacteria, fungus and other microbes. Wall mounting hardware not included (varies according to wall type).

	Stainless Steel		Antimicrobial Metroseal 3	
	Cat. #	S/Each	Cat. #	S/Each
Shelves (2*)				
18"D x 36"L	1300-66	154.00	1300-98	54.00
18"D x 48"L	1300-68	182.00	1300-99	64.00
Shelf Supports (4*)	1306-74	55.00	1306-70	30.00
Shelf Posts (2*)	2650-10	78.00	2650-09	43.00

* Order quantity indicated in parenthesis to create one shelving unit

CHANGE ROOM RACKS



A./B. Upright and Wall-Mount Garment Racks

Electropolished stainless steel construction and open wire design promotes ultra-clean conditions. Features unique hanger capture mechanism to ensure proper positioning at 3" intervals and to deter theft. Both models include electropolished stainless steel hangers; upright models include leveling feet. To meet ESD requirements, select aluminum split sleeves (on facing page). All units are 24"D; upright models are 74"H.

No. of Hangers	A. Upright Cat. #	S/Each	B. Wall-Mount Cat. #	S/Each
36"	11 2650-16	1,130.00	2650-20	596.00
48"	15 2650-17	1,229.00	2650-21	779.00
60"	19 2650-18	1,712.00	2650-22	988.00
72"	23 2650-19	1,773.00	2650-231,072.00	



C. Gowning Bench

Made of 14-gauge, 304 stainless steel, with stainless steel leveling footplates.

Dimensions	Cat. #	S/Each
16" x 36"	2650-24	705.00
16" x 48"	2650-25	836.00
16" x 60"	2650-26	762.00

D. Economy Garment Rack

Made of chrome-plated wire racks, this configuration of Metro Super Erecta shelving creates a versatile garment storage rack. See TerraUniversal.com for other shelving.

Quantity	Item	Cat. #	S/Each
4	74.625" H Corner Post	1300-89	19.00
2	24" x 48" Chrome Wire Shelf	1300-53	63.00
4	Footplate	1301-78	7.00
1	Chrome Support Frame	2650-28	46.00
1	Chrome Hanger Tube	1302-19	28.00
15	Closed Top Loop Chrome Hanger	2650-29	13.00

STARSYS™ MOBILE WORKCENTERS

Moving? Take your lab with you!

Starsys lets you choose from an array of modular, mobile units to fit your changing work and space requirements.

- Fast, efficient lab installation
- Easy reconfiguration
- Flexible door, drawer and cabinet designs
- Corrosion-proof, noncontaminating polymer construction
- Greater storage density in a smaller footprint



Visit TerraUniversal.com for complete information!



Blue Prices: items usually ship in 1-3 days. Order: 714-578-6000



Vol. 4 No. 15

METRO CLEANROOM and LAB UTILITY CARTS



A

**Three-Shelf Cart (No. 1532-53)
Microban® Antimicrobial
Formulation Available!**



B

**Three-Shelf Deep-Ledge Cart
(No. 1532-57)
Microban® Antimicrobial
Formulation Available!**

A. Polymer Utility Carts with Adjustable Shelves

Made of tough, chemical-resistant, high-density polyethylene, an extremely resilient polyolefin that provides excellent chemical resistance and wipes down easily. Raised "ship's edge" lip (.44"/11mm) contains spills. Height: 33.25" (other sizes and configurations available). Microban antimicrobial models available (see item "C" on facing page).

2-Shelf Models		Blue	
W" x L"	Cat. #		\$/Each
18 x 28	1532-12A		145.00
21.5 x 33.75	1532-47A		156.00
27 x 39.5	1532-13A		183.00
3-Shelf Models		Blue	
W" x L"	Cat. #		\$/Each
18 x 28	1532-14A		169.00
21.5 x 33.75	1532-53A		191.00
27 x 39.5	1532-15A		223.00



D

Series 100 - Two stainless steel solid shelves (see chart below)



E

Series 200 - Three stainless steel solid shelves (see chart below)

B. Polymer "Deep Ledge" Carts with Adjustable Shelves

Similar to models above, but with 2.75" (70mm)-deep shelf ledges for enhanced spill containment. All models are 41"H. Color: Blue.

W" x L"	Configuration	Cat. #	\$/Each
21.5 x 32.75	2-shelf	1532-56	163.00
21.5 x 32.75	3-shelf	1532-57	201.00
27 x 38.75	2-shelf	1532-58	191.00
27 x 38.75	3-shelf	1532-59	238.00

Dozens more at TerraUniversal.com!



F

Series 400 - Two chrome wire shelves and one stainless steel solid shelf.



G

Series 600 - Two wire shelves, chrome or stainless steel.



H

Series 700 - Shown with optional bin. Three wire shelves, in a choice of chrome or stainless steel.

Ordering Information		D. Series 100		E. Series 200		F. Series 400		G. Series 600		H. Series 700	
Dimensions (W" x L" x H")	Caster Dia.	Cat. #	\$/Each	Cat. #	\$/Each	Cat. #	\$/Each	Stainless Steel Wire Shelves		Stainless Steel Wire Shelves	
18 x 24 x 38	4"	1401-23	458.00	1401-44	612.00	1401-54	305.00	1402-39	429.00	1402-56	581.00
18 x 30 x 38	4"	1401-24	518.00	1401-45	676.00	1401-55	345.00	1402-41	489.00	1402-58	643.00
18 x 36 x 38	4"	1401-25	518.00	1401-46	676.00	1401-56	345.00	1402-43	489.00	1402-60	643.00
21 x 36 x 39	5"	1401-26	556.00	1401-47	739.00	1401-57	376.00	1402-45	548.00	1402-62	724.00
24 x 36 x 39	5"	1401-27	592.00	1401-48	786.00	1401-58	396.00	1402-47	578.00	1402-64	767.00

CLEANROOM and WAFER FAB CARTS

C. Polymer Carts with Microban® Antimicrobial Product Protection (not shown)

Built-in Microban® formulation inhibits growth of bacteria, mold and mildew. Construction is otherwise identical to corresponding carts on this page.

For Molded-Handle Units (Style "A" left)

W" x L"	Configuration	Cat. #	S/Each
18 x 28	2-shelf	1532-81	159.00
18 x 28	3-shelf	1532-82	171.00
21.5 x 33.75	2-shelf	1532-83	187.00
21.5 x 33.75	3-shelf	1532-84	211.00

For Deep-Ledge Units (Style "B" left)

W" x L"	Configuration	Cat. #	S/Each
21.5 x 32.75	2-shelf	1532-85	181.00
21.5 x 32.75	3-shelf	1532-86	222.00

D - H. Super Erecta® Carts with Adjustable Shelves

Many designs available with chrome-plated and stainless steel wire and solid shelves.

I. Wafer Box Carts

Electropolished stainless steel for Class 1 cleanliness. Spring-loaded casters for smooth rolling.

	Cat. #	S/Each
Rod Shelves	9600-14	3,427.00
Perforated Shelves	3505-05	2,873.00

J. "Dead Man" Cart

Features polypropylene construction with a spill containment area. "Dead Man" braking system prevents carts from rolling while unattended.

Cat. #	S/Each
6017-73	6,735.00

K. Bottle Cart

Electropolished stainless steel construction, clean casters, and ergonomic design make this cart ideal for safely transporting 5' process gas canisters. Includes retaining chain.

	Cat. #	S/Each
12.3"W x 31"D x 57"H.	9600-18	2,056.00

L - N. Acid Transport Carts

Made of stress-relieved polypropylene, these carts resist acids and corrosives used in wet processing applications. All three designs feature recessed receptacles that collect spills into an easy-empty containment reservoir. Acid-resistant neoprene swivel casters are included.

Type L features removable 7" x 7" inserts

Type M is ideal for larger, heavy containers.

Compartments: two @ 17" x 26.5" x 17" and two @ 17" x 36.5" x 14"

Type N features 24 angled 7" x 7" slots for one-gallon bottles and one top compartment for gloves, safety glasses and other small items.

Polypropylene Acid Transport Carts

Type (see photos)	No. of Compts.	Cat. #	S/Each
L	12	3401-00	2,384.00
L	18	3401-01	2,883.00
M	4	3401-30	2,630.00
N	25	3401-31	3,386.00

Floor-Lock Brake

Cat. #	S/Each
3401-04	188.00



Blue Prices: items usually ship in 1-3 days. Order: 714-578-6000



MADE in the U.S.A.

Vol. 4 No. 15

GARMENT and SUPPLIES CABINETS

BUY ONLINE! Items priced in blue usually ship in 1-3 days.

Now in Stainless Steel and Powder-Coated Steel Designs

Type A: Garment storage only.

Type B: Garment storage and adjustable shelves (order desired shelf type separately).

Type C: Adjustable shelves only (order desired shelf type separately).

Type D: Includes two chrome-plated wire shelves adjustable in 1" intervals.

All models are fabricated of stainless or cleanroom powder-coated steel. All except type "C" are available with overhead HEPA filter/blower module that showers contents with particle-free air to dislodge and wash away contaminants.



A No. 4101-00B with optional hangers



B No. 4101-04B with optional hangers and shelves

HEPA-filtered models dislodge and remove particles



C No. 4101-09B with optional shelves



D No. 4205-00B, two shelves included

Powder-Coated Steel (see stainless steel models on facing page)

Specifications		Powder-Coated Steel Cabinets*				Corresponding Shelves				
Type	Outside Dimensions (W" x D" x H")	Powder-Coated Steel w/ Acrylic Doors		Powder-Coated Steel w/ Dissip. PVC Doors		Polypropylene Shelves		Powder-Coated Steel Shelves		
		Cat. #	\$/Each	Cat. #	\$/Each	Cat. #	\$/Each	Cat. #	\$/Each	
A	Filter/Blower	36 x 20 x 94	4101-00B	2,419.00	4101-14B	2,918.00	—	—	—	—
	Cabinet Only	36 x 20 x 78	4101-01B	1,803.00	4101-15B	2,420.00	—	—	—	—
B	Filter/Blower	36 x 24 x 83	4101-02B	2,156.00	4101-16B	2,736.00	—	—	—	—
	Cabinet Only	36 x 24 x 67	4101-03B	1,686.00	4101-17B	2,229.00	—	—	—	—
B	Filter/Blower	48 x 20 x 94	4101-04B	2,819.00	4101-18B	3,320.00	4101-30	43.00	4101-40A	81.00
	Cabinet Only	48 x 20 x 78	4101-05B	2,758.00	4101-19B	3,292.00	4101-30	43.00	4101-40A	81.00
B	Filter/Blower	48 x 24 x 83	4101-06B	2,569.00	4101-20B	3,570.00	4101-31	43.00	4101-41A	81.00
	Cabinet Only	48 x 24 x 67	4101-07B	2,100.00	4101-21B	2,634.00	4101-31	43.00	4101-41A	81.00
C	Cabinet Only	30 x 14 x 78	4101-09B	1,376.00	4101-23B	1,856.00	4101-32	62.00	4101-42A	111.00
	Cabinet Only	30 x 18 x 78	4101-11B	1,429.00	4101-25B	1,910.00	4101-33	62.00	4101-43A	111.00
C	Cabinet Only	36 x 20 x 78	4101-13B	1,603.00	4101-27B	2,015.00	4101-28	62.00	4101-44A	111.00
	Filter/Blower	37.75 x 26.5 x 86	4205-00B	2,853.00	4205-02B	3,545.00	Additional Wire Shelves (Type D)			
D	Cabinet Only	37.75 x 26.5 x 72	4205-01B	2,432.00	4205-03B	3,043.00	36"W x 24"D	Cat. # 1300-51	\$/Each 54.00	

* Includes built-in stand with leveling feet.

Steel-reinforced doors with locks available on all models—ordering information at TerraUniversal.com

A./B. UltraClean™ Cylinder Tube Garment Racks

Made of high-grade electropolished stainless steel, these racks feature sloping 1½"-diameter cylindrical tube frames that are easy to wipe down. Fixed position design keeps garments firmly in place.

See ordering chart below.

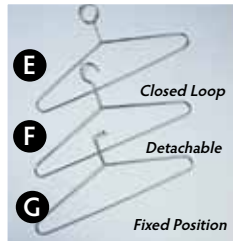

Electropolished Cleanroom Hanger			
Type	For Rack Type	Cat. #	\$/Each
E	C	1530-30-2	14.00
F	A, B or C	1530-31-2	14.00
G	A, B or D	1530-32-2	14.00



C. UltraClean™ Square Tube Garment Racks

These electropolished racks can be disassembled for easy storage and shipping. They are available with one or two hanger rods, in configurations for closed-loop or detachable hangers (photos C and D).

See ordering chart below.

D. Fixed Position Hanger Rods

This style is available with square-tube racks. Slots at 3" increments keep garments from bunching together. Requires fixed-position hangers (photo G).

See ordering chart below.

Cylinder Frame Rack
(1½"-diameter tubes)
Overall height: 76"
For use with detachable hangers.



Square-Tube Rack Sliding position style for use with closed-loop or detachable hangers.
Overall height: 74"

QUICK Ship

Electropolished Stainless Steel Garment Storage Racks

Type <small>See photos above</small>	Dimensions	Hanger Capacity <small>(order separately)</small>		A./B. Cylinder Tube Frame <small>(order hanger 1530-32-2 separately)</small>				C./D. Square Tube Frame			
		Single Rack	Dual Rack	A. Single-Rack		B. Dual-Rack		Single-Rack		Dual-Rack	
				Cat. #	\$/Each	Cat. #	\$/Each	Cat. #	\$/Each	Cat. #	\$/Each
C. Sliding Position <small>(order closed loop or detachable hangers)</small>	48"W x 24"D	15	30	—	—	—	—	9230-00-2	910.00	9230-04-2	1,434.00
	60"W x 24"D	19	38	—	—	—	—	9230-01-2	1,146.00	9230-05-2	1,608.00
	72"W x 24"D	23	46	—	—	—	—	9230-02-2	989.00	9230-06-2	1,925.00
	84"W x 24"D	27	54	—	—	—	—	9230-03-2	1,347.00	9230-07-2	2,067.00
A, B, & D. Fixed Position <small>(order fixed position hangers)</small>	48"W x 24"D	15	30	9602-67	1,347.00	9602-75	2,505.00	9230-08-2	1,063.00	9230-12-2	1,948.00
	60"W x 24"D	19	38	9602-68	1,659.00	9602-76	2,929.00	9230-09-2	1,325.00	9230-13-2	2,294.00
	72"W x 24"D	23	46	9602-69	1,805.00	9602-77	3,349.00	9230-10-2	1,440.00	9230-14-2	2,526.00
	84"W x 24"D	27	54	9602-70	1,975.00	9602-78	3,550.00	9230-11-2	1,569.00	9230-15-2	2,793.00

Stainless Steel Garment & Supplies Cabinets (see powder-coated steel models on facing page)

Specifications		Garment Storage Cabinets*				Shelves		
Type	Outside Dimensions <small>(W" x D" x H")</small>	Stainless Steel w/ Acrylic Doors		Stainless Steel w/ Dissip. PVC Doors		Stainless Steel		
		Cat. #	\$/Each	Cat. #	\$/Each	Cat. #	\$/Each	
A	Filter/Blower Cabinet Only	36 x 20 x 94	4101-57A	5,301.00	4101-68A	5,760.00	—	—
	Filter/Blower Cabinet Only	36 x 20 x 78	4101-58A	4,064.00	4101-69A	4,554.00	—	—
	Filter/Blower Cabinet Only	36 x 24 x 83	4101-59A	4,879.00	4101-70A	5,339.00	—	—
	Filter/Blower Cabinet Only	36 x 24 x 67	4101-60A	3,625.00	4101-71A	4,114.00	—	—
B	Filter/Blower Cabinet Only	48 x 20 x 94	4101-61A	6,218.00	4101-72A	6,677.00	4101-83A	245.00
	Filter/Blower Cabinet Only	48 x 20 x 78	4101-62A	6,063.00	4101-73A	6,551.00	4101-83A	245.00
	Filter/Blower Cabinet Only	48 x 24 x 83	4101-63A	4,728.00	4101-74A	6,014.00	4101-84A	245.00
	Filter/Blower Cabinet Only	48 x 24 x 67	4101-64A	4,554.00	4101-75A	5,043.00	4101-84A	245.00
C	Filter/Blower Cabinet Only	30 x 14 x 78	4101-65A	2,891.00	4101-76A	3,334.00	4101-85A	257.00
	Filter/Blower Cabinet Only	30 x 18 x 78	4101-66A	3,157.00	4101-77A	3,456.00	4101-86A	245.00
	Filter/Blower Cabinet Only	36 x 20 x 78	4101-67A	3,261.00	4101-78A	3,702.00	4101-87A	245.00
	Filter/Blower Cabinet Only	37.75 x 26.5 x 86	4101-79A	5,076.00	4101-81A	5,584.00	—	—
D	Filter/Blower Cabinet Only	37.75 x 26.5 x 72	4101-80A	4,287.00	4101-82A	4,738.00	—	—

* Height includes built-in stainless steel stand with leveling feet.



Type D Stainless Steel Cabinet (No. 4101-80A, shown with one optional shelf)



A



B Install next to hand washer



C Accommodates multiple glove sizes or materials



D For gloves, hoods, face masks*



E



F Organizes small parts



G



H



I Hinged top keeps wipers clean



J



K

GARB AND PARTS DISPENSERS

Space-Saving Convenience!

These handy dispensers save space and organize gloves, safety glasses, wipers, hats, and other garb. They're perfect benchtop storage bins for small parts used in cleanroom processing. Select clear acrylic or static-dissipative PVC, which eliminates static charges and the particles they attract.

Item (see photos)	Dimensions WxDxH, in	Acrylic		Static-Dissipative PVC	
		Cat. #	\$/Each	Cat. #	\$/Each
A. SneezeGuard™	7.12 x 7.75 11 x 11	1601-50	16.00	1601-51	26.00
		1600-25	19.00	1602-75	29.00
B. Wall-Mount Glove Dispenser (single)	16.5 x 12.5 x 17	4950-72	257.00	4950-74	347.00
C. Wall-Mount Glove Dispenser (triple)	16 x 11.5 x 12	4005-56	286.00	4005-57	432.00
D. Benchtop Glove Dispenser*	12 x 6 x 6	4951-03	89.00	4951-04	134.00
E. File Holder (4 slots)	10.5 x 5 x 15	4005-25	103.00	4005-23	184.00
F. Dispensing Bins	5 x 6.25 x 8.25	4950-12	149.00	4950-13	259.00
G. Apparel Dispenser	48.5 x 24.5 x 36	4951-06	3,564.00	4951-07	6,340.00
H. Multi-Chamber Dispenser	15.75 x 8 x 13	4005-51	379.00	4005-50	565.00
I. Wiper Dispenser (enclosed)	12 x 9 x 6	4951-01	97.00	4951-02	172.00
J. Wiper Dispenser (open top)	10.5 x 14.5 x 4	4950-93	69.00	4950-94	128.00
K. Safety Glasses Dispensers Holds: (all are 5.75"D)	8	4950-45	282.00	4950-46	354.00
	12	4951-15	369.00	4951-16	438.00
Other sizes available— call Terra!	16	4951-17	461.00	4951-18	607.00
	16	4951-19	461.00	4951-20	607.00
	24	4951-21	599.00	4951-22	788.00
	24	4951-23	599.00	4951-24	868.00
*Now available in stainless steel— see facing page.	32	4951-25	912.00	4951-26	1,092.00
	48	4951-27	1,078.00	4951-28	1,510.00

STAINLESS STEEL LAB AIDS



A

Dispenser Mounting System—
Ideal for limited benchtop &
wall space



L



M



N



O



B

Models for loose or packaged gloves

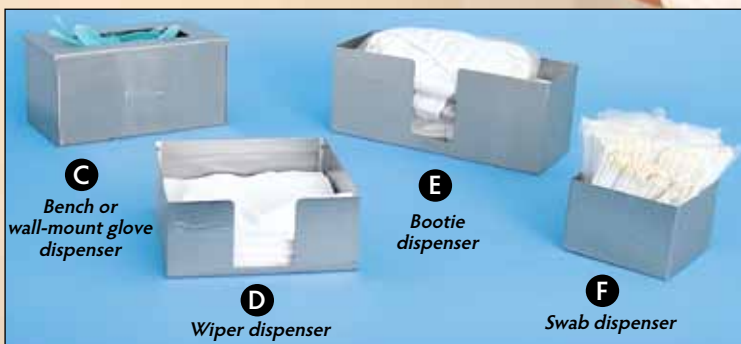

C

Bench or
wall-mount glove
dispenser

E

Bootie
dispenser

D

Wiper
dispenser

F

Swab
dispenser

Stainless Steel Cleanroom and Lab Aids

Convenient racks, dispensers and tools. Dozens of other models at TerraUniversal.com

Item (see photos) — includes anit-microbial coating	Dimensions W x D x H, in.	Electropolished 304 SS	
		Cat. #	\$/Each
A. Glove Dispenser, Wall-mount	27 x 7 x 24 (3 compartment)	4951-30-2	1,129.00
	34.5 x 8 x 24 (4 compartment)	4951-31-2	1,489.00
B. Glove Dispenser, Wall-mount	24 x 8 x 24 (3 compartment)	4951-32-2	1,172.00
	32 x 8 x 24 (4 compartment)	4951-33-2	1,489.00
C. Glove Dispenser	12 x 6 x 6	4951-50-2	131.00
D. Wiper Dispenser	12 x 9 x 6	4951-40-2	134.00
	9.5 x 9.5 x 6	4951-41-2	148.00
E. Bootie Dispenser	15 x 6 x 6	4951-45-2	166.00
F. Swab Dispenser	6 x 4 x 6	4951-35-2	65.00
G. Glove Dispenser	5.5 x 3.75 x 20 (2 boxes)	4951-51-2	67.00
H. Glove Dispenser	5.5 x 3.75 x 30 (3 boxes)	4951-52-2	74.00
I. Glove Dispenser	5.5 x 3.75 x 10 (1 boxes)	4951-53-2	60.00
J. Glove Dispenser	12 x 3.75 x 10 (2 boxes)	4951-54-2	66.00
K. Glove Dispenser	18 x 3.75 x 10 (3 boxes)	4951-55-2	84.00
L. Glove Dispenser with Waste Bin	24 x 18.5 x 59 (3 compartments + waste bin)	4951-34-2	2,441.00
M. Mounting on Terra Workstation*	27 x 1.5 x 30 above work surface	4951-90-2	500.00
N. Mounting on Terra Gowning Bench*	27 x 1.5 x 66 above floor	4951-91-2	500.00
O. SS Clipboard	12 x 9.5	1350-00A-2	59.00

* price includes installation; order gowning bench and dispenser separately



4951-51A-2

G. – K.
Glove
Dispensers— many
sizes available.

**BUY
ONLINE!**

Blue Prices: items usually ship in 1–3 days. Order: 714-578-6000



Vol. 4 No. 15

GOWNING ROOM and CLEANROOM FURNISHINGS

BioSafe® Frameless Wall-Mount Mirrors—
Unique mounting system hugs wall,
eliminates gaps that harbor contaminants



Cleanroom Mirrors

Frameless models feature a recessed mounting plate for flush-mounting on the cleanroom wall without rear offset space that can accumulate dust and germs. Caulking creates an easy-clean surface that acts as a germ barrier. Framed models include an ultra-smooth, mirror-finish SS frame with sloping edges to minimize particle build-ups.

Size W" x H"	With Frame EP 304 Stainless Steel		Frameless	
	Cat. #	S/Each	Cat. #	S/Each
Heavy Duty 36 x 72	5252-52A	1,388.00	5252-58B	1,217.00
24 x 36	5252-53	937.00	5252-61B	859.00
18 x 24	5252-54	638.00	5252-60B	558.00
24 x 72	5252-55	1,144.00	5252-59B	1,001.00
24 x 48	5252-56	1,072.00	5252-63B	938.00
18 x 36	5252-57	844.00	5252-62B	774.00

Gowning Benches

Terra's all-electropolished 304 stainless steel gowning benches provide the ideal gowning surface. Their ultra-smooth surfaces won't shed particles or snag wipers. Choose among four designs; all freestanding models come with durable nylon leveling feet. Perforated top and 316 stainless steel models available at TerraUniversal.com.

Floor Mounted (see photo A)			Free Standing Design (see photos B, C, D)					Bootie Rack** (not shown)				
L" x W" x H" Nominal	A. Solid Top		B. Solid Top		C. Tubular Top		D. Cylinder-Frame/ Tube-Top		No. of Slots	E. Installed		
	Cat. #	S/Each	Cat. #	S/Each	Cat. #	S/Each	Cat. #	S/Each		Cat. #	S/Each	
36 x 9 x 18	1530-15-2	843.00	36 x 16 x 18	1530-25-2	922.00	1530-10-2	1,367.00	9602-96	1,564.00	12	1560-30-2	665.00
48 x 9 x 18	1530-16-2	914.00	48 x 16 x 18	1530-26-2	1,017.00	1530-11-2	1,681.00	9602-97	1,791.00	15	1560-31-2	775.00
60 x 9 x 18	1530-17-2	1,007.00	60 x 16 x 18	1530-27-2	1,188.00	1530-12-2	1,925.00	9602-98	2,067.00	18	1560-32-2	883.00
72 x 9 x 18*	1530-18-2	1,103.00	72 x 16 x 18	1530-28-2	1,268.00	1530-13-2	2,065.00	9602-99	2,246.00	21	1560-33-2	994.00
84 x 9 x 18*	1530-19-2	1,157.00	84 x 16 x 18	1530-29-2	1,181.00	1530-14-2	2,461.00	9600-02	2,454.00	24	1560-34-2	1,104.00

* Includes center leg mount. ** Fits on free-standing benches only (order bench separately).



A – I. Electropolished Step Stools and Ladders

Include spring-loaded safety casters that retract under load. Perforations limit particle accumulation. Custom sizes and 316 SS available.

304 Stainless Steel Step Stools and Ladders

	Top Platform (W" x D")	Overall Dimensions (W" x D" x H")	No. of Steps	Electropolished 304 Stainless Steel	
				Cat. #	S/Each
A	30 x 14	30 x 20 x 24	2	2805-50A-2	1,891.00
B	30 x 12	30 x 28 x 34	3	2805-51A-2	2,380.00
C	30 x 12	30 x 24 x 60	3*	2805-53A-2	2,761.00
D	30 x 12	30 x 30 x 70	4*	2805-52A-2	4,037.00
E	30 x 16	30 x 40 x 80	5*	2805-54A-2	4,928.00
F	30 x 36	30 x 76 x 86	5*	2805-55A-2	5,152.00
G	15 x 10	18 x 16 x 20	1	2805-80A	836.00
H	15 x 10	18 x 22 x 35	2	2805-81A	1,205.00
I	15 x 10	18 x 25 x 44	3	2805-82A	1,416.00
J	11 x 17	21 x 27 x 48	3	2805-97	2,520.00

* Includes safety handrail. C – E not shown



K – O. Waste Receptacles

ValuLine™ models, suitable for general use, are stainless steel. BioSafe® models, optimized for the cleanest locations, are either electropolished SS or polypropylene and feature a soft-close feature to eliminate abrupt noises when the lid closes.



- ▲ **BioSafe® Models:** eliminate piano-style hinges and other hardware that harbors contaminants; all non-corroding materials (electropolished stainless steel or polypropylene) - perfect for critical environments. SoftClose™ feature lets lid close without a loud crash!
- ▲ **ValuLine™ Models:** suitable for general laboratory use.

BioSafe™ Cleanroom Waste Receptacles

Type	Capacity (Gallons)	Dimensions W x D x H (in.)	Ship. Wt. (lbs.)	Electropolished 304 Stainless Steel		Ship. Wt. (lbs.)	Polypropylene		ValuLine Waste Receptacles 304 Stainless Steel	
				Cat. #	S/Each		Cat. #	S/Each	Cat. #	S/Each
K	3.5	11 dia. x 17 H	9	—	—	9	—	—	1456-00	308.00
L	7	12 x 12 x 17	19	1456-16B	656.00	19	1456-25A	629.00	1456-01	473.00
M	12	12 x 12 x 23	24	1456-17B	1,006.00	24	1456-26A	767.00	1456-02	558.00
N	24	15 x 15 x 30	36	1456-18B	1,162.00	36	1456-27A	879.00	1456-03	772.00
O	40	19 x 19 x 30	48	1456-19B	1,552.00	48	1456-28A	1,047.00	1456-04	956.00



Blue Prices: items usually ship in 1–3 days. Order: 714-578-6000



MADE IN THE U.S.A.

Vol. 4 No. 15

CLEANROOM ACCESSORIES

ErgoHeight™ Work Stations

- Eliminates back stress and injury, enhances productivity
- Provides up to four programmable height settings
- Smooth bench motion — suitable for microscopes and delicate process equipment
- Supports up to 400 pounds net load
- No need to clear work surface for height adjustment!
- Cleanroom-compatible materials

Motorized lifters raise, lower and level the work surface to any of four programmed pre-sets—without disturbing table-top set-ups. Front panel-mounted controls provide pushbutton convenience. Sealed design isolates motor for cleanroom compatibility. Models below feature powder-coated white bases; dozens of other sizes and configurations available. Standard height range: 28" – 48" floor-to-top.

Turnkey solutions for vibration isolation and exhaust fume removal:
TerraUniversal.com

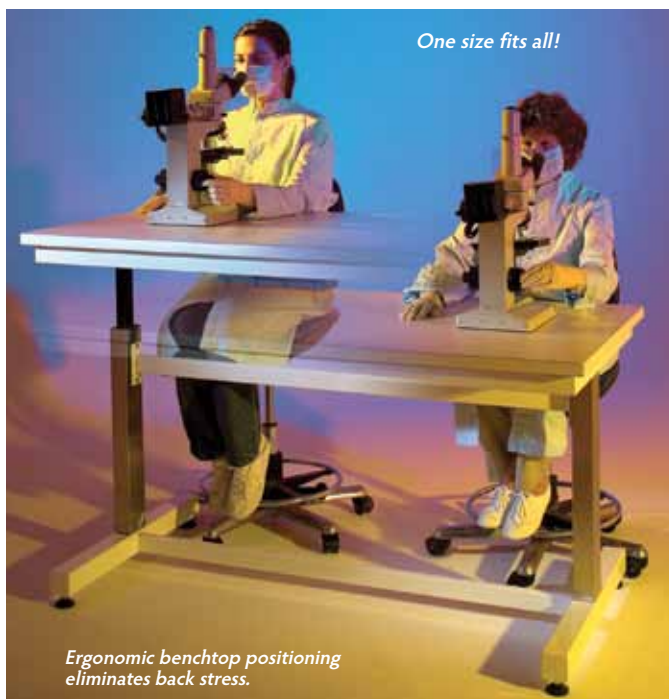

ErgoHeight Auto-Adjustable Cleanroom Work Stations

Benchtop Dimensions (W" x D")	Powder-Coated Steel Bases								Stainless Steel Bases			
	Nonconductive Top		Static-Dissipative Top		Polypropylene Top		Stainless Steel Top		Stainless Steel Top		Electropolished Top and Base	
	Cat. #	\$/Each	Cat. #	\$/Each	Cat. #	\$/Each	Cat. #	\$/Each	Cat. #	\$/Each	Cat. #	\$/Each
36 x 30	3504-16	2,758.00	3504-24	3,040.00	3504-32	3,050.00	3504-04	3,195.00	3504-40	3,574.00	3504-00	3,972.00
48 x 30	3504-17	2,864.00	3504-25	3,177.00	3504-33	3,186.00	3504-05	3,331.00	3504-41	3,730.00	3504-01	4,129.00
60 x 30	3504-18	3,065.00	3504-26	3,350.00	3504-34	3,357.00	3504-06	3,504.00	3504-42	3,864.00	3504-02	4,230.00
72 x 30	3504-19	3,186.00	3504-27	3,469.00	3504-35	3,477.00	3504-07	3,623.00	3504-43	3,985.00	3504-03	4,383.00
36 x 34	3504-20	2,855.00	3504-28	3,138.00	3504-36	3,146.00	3504-08	3,292.00	3504-44	3,671.00	3504-12	4,069.00
48 x 34	3504-21	2,926.00	3504-29	3,178.00	3504-37	3,217.00	3504-09	3,363.00	3504-45	3,798.00	3504-13	4,196.00
60 x 34	3504-22	3,098.00	3504-30	3,350.00	3504-38	3,388.00	3504-10	3,535.00	3504-46	3,931.00	3504-14	4,347.00
72 x 34	3504-23	3,217.00	3504-31	3,500.00	3504-39	3,508.00	3504-11	3,654.00	3504-47	4,051.00	3504-15	4,448.00



A. Motorized Shoe Cleaner

Internal vacuum system removes contaminants on shoes. Five internal brushes clean deep into seams, welts.

	Cat. #	\$/Each
110VAC/60Hz	1784-14	2,995.00
220VAC/50Hz	1784-14-220	3,325.00

B. Cleanline® Sticky Mats®

Peel-off sheets eliminate the need for messy cleaning and make it easy to maintain a clean surface. Models are available with full-bottom adhesive surfaces and 2" bottom adhesive strips. Optional mounting frame (shown in photo) provides a sturdy, easy-to-clean edging. Many other sizes and colors, along with high-tack models, are available at TerraUniversal.com.

BUY ONLINE! Items priced in blue usually ship in 1-3 days.

Sticky Mats—All are medium tack (high tack and other sizes, colors available)

Dim. (inches)	Blue				Gray		Corresponding Frame	
	Full Bottom		2" Strip Bottom		2" Strip Bottom		(Adds 3" to each side)	
	Cat. #	\$/Each	Cat. #	\$/Each	Cat. #	\$/Each	Cat. #	\$/Each
18 x 36	5601-16	45.00	5601-24	40.00	5602-20	40.00	5602-92	116.00
18 x 45	5601-17	50.00	5601-25	45.00	5602-21	45.00	5602-94	131.00
24 x 36	5601-18	60.00	5601-26	55.00	5602-22	55.00	5602-97	143.00
36 x 45	5601-21	105.00	5601-29	95.00	5602-25	100.00	5603-04	194.00
36 x 60	5601-22	155.00	5601-30	145.00	5602-26	155.00	5603-05	222.00

HAND, GLOVE and SHOE CLEANERS

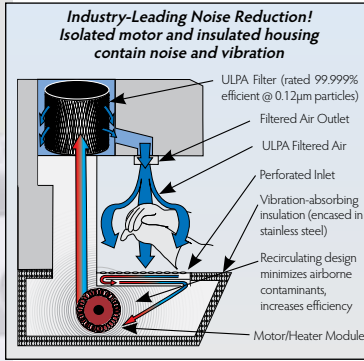

Dimensions: 15"W x 21¹/₈"H x 11"D
Heater: 1600W

PureDry™ Hand/Glove Dryer		
	Cat. #	S/Each
120VAC/60Hz	3333-33	2,307.00
220VAC/50Hz	3333-33-220	2,307.00

Brushless motor for clean operation

BUY ONLINE! Items priced in blue usually ship in 1-3 days.

PureDry™ Hand Dryer

- Provides warm, contamination-free air for drying hands and gloves
- Also ideal for drying tools, bottles, microelectronic components and other small materials
- Eliminates the need for towels that shed particles and harbor germs
- ULPA (Ultra Low Penetration Air) filter captures microcontaminants
- Insulation and motor isolation reduce noise and vibration levels
- Recirculating air design minimizes turbulence for enhanced cleanliness
- Wide exposure area allows complete drying of elbow-length gloves
- Photo-electric cell and adjustable timer allow no-touch operation



The only cleanroom-compatible, integrated washing/drying station!

Washing/Drying Station

- Incorporates washing and ULPA-filtered drying modules in one cleanroom-compatible station
- Hands-free, noncontaminating activation
- Optional liquid soap dispenser is ideal for aseptic cleaning

Hand/Glove Cleaning Station

Dimensions (W x D x H) Includes levelers	No. of Sinks	Stainless Steel				Electropolished Stainless Steel				Soap Dispensing Module	
		110VAC/60Hz		220VAC/50Hz		110VAC/60Hz		220VAC/50Hz		Order one per sink	
		Cat. #		Cat. #	S/Each	Cat. #		Cat. #	S/Each	Cat. #	S/Each
24" x 22" x 61"	1	9600-60	5,417.00	9600-60-220	5,525.00	9600-05	6,877.00	9600-05-220	6,272.00	9600-64	233.00
48" x 22" x 61"	2	9600-61	10,662.00	9600-61-220	10,770.00	9600-06	12,230.00	9600-06-220	12,230.00	9600-64	233.00
96" x 22" x 61"	4	9600-62	19,704.00	9600-62-220	19,704.00	9600-07	23,041.00	9600-07-220	23,041.00	9600-64	233.00
144" x 22" x 61"	6	9600-63	28,849.00	9600-63-220	29,849.00	9600-08	34,854.00	9600-08-220	34,854.00	9600-64	233.00



Sole Cleaner™ Automatic Contamination-Control Mat

- Unique system automatically maintains a sticky surface that removes particles from shoe soles
- Controller counts foot passes and replaces surface at programmed intervals
- Self-regenerating design eliminates monitoring and maintenance costs
- Take-up roller draws particle-laden surface inside housing to minimize contamination

Terra's Sole Cleaner™ provides the ultimate in shoe sole cleaning! Its automated design minimizes the hassle, expense, and uncertainty associated with other adhesive shoe mats.

Just program the acceptable number of foot passes and the Sole Cleaner guarantees a sticky surface throughout a work shift. Its low-profile design is ideal for carts, and replacement rolls take only seconds to install.

Cat. #	S/Each
2010-50	25,358.00

BUY ONLINE!

Blue Prices: items usually ship in 1-3 days. Order: 714-578-6000



MADE
in the
U.S.A.

Vol. 4 No. 15



Acrylic chamber for Terra Hardwall Cleanroom, No. 6704-90B



Acrylic chamber, No. 6704-90B



Stainless steel chamber, No. 6705-26C



CleanTop™ easy-clean sloped top, No. 6705-17



CleanSeam™ stainless steel designs with all-continuous seam welds



Fire-Rated Pass-Through, No. 2641-02



Stainless steel ventilation module, No. 6705-23



Ruggedized Pass-Through, No. 2640-66



Now with all-304/316 stainless steel latches to eliminate scratching, corrosion and contamination common with plated hardware.



- **Seamless** — Unique design eliminates cracks, corners and other contaminant traps!
- **Lipless** — Easy material transfer with no clearance obstruction
- **Easy to Clean** — Ultra-smooth internal surfaces
- **Easy to Sterilize** — 304/316 electropolished SS; removable doors can be steam sterilized
- **Double-Wall, Sealed Construction** — adds rigidity and houses interlock and standard or custom utilities without compromising the ultra-clean design

MODULAR CLEANROOMS



Convert any space into a controlled environment — at a fraction of the cost, in a fraction of the time!

A



B Hardwall rooms comply with USP-797 requirements



E ValuLine™ Cleanrooms—ship in 5 days



Multi-room hardwall cleanroom with polycarbonate panels

C



Hardwall cleanroom with internal-mount polypropylene panels for easy cleaning, A/C, and high speed CleanSeal® Roll-Up Doors

F



Hardwall Acrylic ISO 7 Cleanroom
 Reference No. 131609
 Total Square Footage: 1391
 Cost: \$159,158

D



304 stainless steel BioSafe Cleanroom

G



Versatile BioSafe panels accommodate complex cleanroom designs, with interior production rooms and gowning areas dedicated to your workflow and cleanliness requirements

H

MODULAR CLEANROOMS

Free-standing, all-steel structures create sturdy, versatile, clean processing solutions that meet cleanliness requirements to Class 10 (ISO 4). Whatever your application, Terra delivers a pre-tested, turnkey system.

Hardwall Designs

- Acrylic or static-dissipative rigid panels for full visibility
- Steel support frame spans up to 20 feet without internal pillars or external supports
- Mirror-finished stainless steel trim creates a showcase exterior
- A/C and humidity controls
- Available raised floors optimize laminar airflow

Models shown:

- Static-dissipative PVC ISO 5 cleanroom interior: includes gowning antechamber with pass-through chamber and 9-foot ceilings.
- Polycarbonate cleanroom designed to USP-797 requirements for compounding pharmacies
- ISO 6 cleanroom with acrylic panels and multi-suite floorplan
- ISO 7 cleanroom with acrylic panels and multi-suite floorplan

Softwall Designs

- New ValuLine™ rooms—full performance at lower cost
- Portable, expandable, easy to assemble and disassemble
- Curtain panels and parting strip shields, in anti-static cleanroom-grade vinyl
- Rigid steel support frame requires no ceiling supports
- Casters available

Models shown:

- ValuLine Softwall Cleanroom provides value without sacrificing performance! Turnkey models start under \$10,000 and ship in 3 – 4 days. Cleanliness to ISO 5 (Class 100).

Configured to Your Specifications!

- Air conditioning
- Humidification/Dehumidification
- Rapid-Operation Doors
- Raised Floor

BioSafe® All-Steel Designs

- Perfect for ultra-clean applications requiring frequent cleaning or sterilization
- Smooth interior walls with radius corners eliminate cracks that harbor germs and particles
- 304/316 stainless or powder-coated steel panels
- Negative-pressure airflow designs available for fume venting

Models shown:

- Powder-coated BioSafe® room with dual quick-response roll-up doors; ideal for transfer of bulky equipment or carts.
- Stainless steel BioSafe ISO 5 cleanroom with air shower entry and ceiling plenum.
- Powder-coated ISO 7 BioSafe cleanroom interior



Blue Prices: items usually ship in 1–3 days. Order: 714-578-6000



Vol. 4 No. 15

WORK BENCHES and CHAIRS

Top designs for all applications—



A Cleanroom laminate



B Stainless steel



C Dampens 90% of building vibrations



D Vibration platform

Note: Benches above are pictured with optional drawer module No. 1740-07 (3", 6" and 12" drawer height); others configurations in both plastic and stainless steel are available.

Work Benches—select desired top (all bases feature a white powder-coated finish)

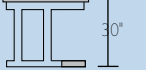
Base Type (Epoxy Finish)	Width (Depth=30")	A. Nonconductive Laminate		B. Stainless Steel		C. Vibration-Free Laminate Top		D. Vibration-Free Platform		
		Cat. #	\$/Each	Cat. #	\$/Each	Cat. #	\$/Each	Work Surface (W" x D" x H")	Electropolished Stainless Steel Top	
Telescoping "A" Base 	48	1722-00	797.00	1521-45	1,348.00	1570-00A	2,004.00	21.75 x 18.25 x 3 23 x 24 x 3	1580-02 1580-03	2,446.00 2,636.00
	60	1724-00	885.00	1751-00	1,447.00	1570-01A	2,038.00			
	72	1726-00	876.00	1752-00	1,512.00	1570-02A	2,053.00			
Recessed "C" Base 	48	1521-09	735.00	1521-54	1,235.00	—	—	Visit TerraUniversal.com for other bench styles: • ErgoHeight™ Adjustable Height Tables • Acid-resistant polypropylene tops • Dozens of standard sizes		
	60	1000-00	816.00	1521-55	1,384.00	—	—			
	72	1000-01	806.00	1521-56	1,383.00	—	—			



Class 100
Static Control
#2802-62



Class 100
Static Control
#2802-68



Class 100
Static Control
#2802-74



Class 100
#1013-08



Class 100
#1013-52

E. – I. Class 100 & Static Control

Clean vinyl meets Class 100 particle requirements. Static-Control chairs feature dissipative vinyl, conductive casters, and grounding chains.

Specs		Class 100 Static Control						Class 100				
Height	Color	E.		F.		G.		H.		Color	I.	
		Cat. #	\$/Each	Cat. #	\$/Each	Cat. #	\$/Each	Cat. #	\$/Each		Cat. #	\$/Each
Desk	Black	2802-61*	529.00	2802-67*	487.00	2802-73*	546.00	1012-05*	489.00	Black	1012-11	569.00
	Blue	2802-62*	529.00	2802-68*	487.00	2802-74*	546.00	1013-08	568.00	Black	1013-51*	568.00
Bench	Black	2802-64*	536.00	2802-70*	490.00	2802-76*	553.00	1012-41	477.00	Black	1012-12	569.00
	Blue	2802-65*	536.00	2802-71*	490.00	2802-77*	553.00	1013-12	568.00	Black	1013-52*	568.00

* Quick ship models—usually ship within one week!

WORK BENCHES and CHAIRS

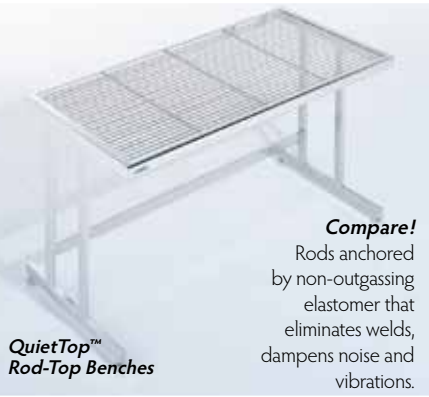

**QuietTop™
Rod-Top Benches**

Compare!
Rods anchored by non-outgassing elastomer that eliminates welds, dampens noise and vibrations.

Competitor's design



Hidden reinforcements minimize dead spots, add strength, and eliminate deflection bounce-back, no matter how large the benchtop.



Open-Top Perf-Top Benches

Heavy-Duty All-Electropolished Stainless Steel Work Stations (800-lb. load capacity)

QuietTop™ Rods with Full Bullnose
ø ¼" rods on 1" centers

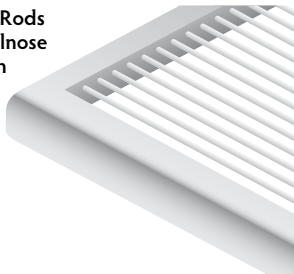

OpenTop™ Perforated with ErgoEdge™
Rounded Front ø ¼" holes

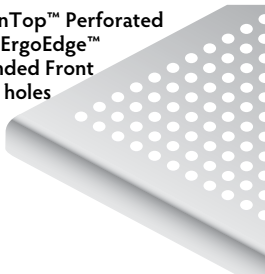

OpenTop Perforated with ErgoEdge
Rounded Front ø ¼" holes

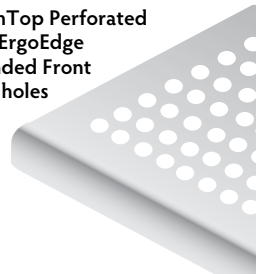

Solid Top with ErgoEdge
Rounded Front

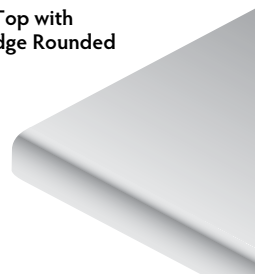

Bench Size * (W x D)	"A" Base			"C" Base			"A" Base			"C" Base		
	Cat. #	Cat. #	\$/Each	Cat. #	Cat. #	\$/Each	Cat. #	Cat. #	\$/Each	Cat. #	Cat. #	\$/Each
36 x 30	9601-17	9601-18	1,987.00	9604-59	9604-80	1,930.00	9601-59	9601-60	1,760.00	9603-01	9603-02	1,546.00
48 x 30	9601-19	9601-20	2,232.00	9604-60	9604-81	2,573.00	9601-61	9601-62	2,458.00	9603-03	9603-04	1,776.00
60 x 30	9601-21	9601-22	2,505.00	9604-61	9604-82	2,770.00	9601-63	9601-64	2,489.00	9603-05	9603-06	1,925.00
72 x 30	9601-23	9601-24	2,933.00	9604-62	9604-83	3,101.00	9601-65	9601-66	2,601.00	9603-07	9603-08	2,155.00
84 x 30	9601-25	9601-26	3,129.00	9604-63	9604-84	3,245.00	9601-67	9601-68	2,763.00	9603-09	9603-10	2,402.00
96 x 30	9601-27	9601-28	3,562.00	9604-64	9604-85	3,826.00	9601-69	9601-70	3,376.00	9603-11	9603-12	2,751.00

* Prices for "A" base and "C" base designs are the same. Standard height is 30" (floor to top). Heights of 32" and 36" and widths of 34" are available at no extra charge. Specify when ordering.

Ergonomic Upholstered #2801-05



Ergonomic Upholstered #2801-33



Ergonomic Upholstered #2801-66



Urethane #1013-16



Ergonomic ESD #1012-24



J. – N. Laboratory Chairs

Select from our large assortment of Laboratory Chairs. Types J-L are upholstered chairs built with ergonomic benefits. Types M and N meet durability and budget needs.

Specs		Ergonomic Upholstered Chairs*						Specs		Urethane Chairs**		ESD Chair	
Height	Color	J. w/Seat Control		K. Standard		L. Large Backrest		Color	M.	N.			
		Cat. #	\$/Each	Cat. #	\$/Each	Cat. #	\$/Each		Cat. #	\$/Each	Cat. #	\$/Each	
Desk	Black	2801-01*	366.00	2801-33*	316.00	2801-65*	332.00	Black	1013-16	283.00	1012-14	477.00	
	Blue	2801-02*	366.00	2801-34*	316.00	2801-66*	332.00		1013-17*	306.00	1012-19	543.00	
Bench	Black	2801-05*	416.00	2801-37*	318.00	2801-69*	336.00	Black	1013-18*	346.00	1012-24	543.00	
	Blue	2801-06*	416.00	2801-38*	318.00	2801-70*	336.00		—	—	1013-46	633.00	

* Available in Grade 2 Vinyl or Grade 4 Breathable Nylon. Visit TerraUniversal.com for more color options.

** More configurations available on the website.



Blue Prices: items usually ship in 1–3 days. Order: 714-578-6000



MADE in the U.S.A.

Vol. 4 No. 15



Polypropylene Cabinet No. 7018-00: ideal for acids (shown with optional gooseneck faucets, spray guns, casters and duplex outlet)



Stainless steel Cabinet No. 7018-01: recommended for solvents and flammable chemicals (shown with optional casters and spray gun)

WET PROCESSING and CLEANING CABINET

- Incorporates all processing components into one self-contained, easy-to-clean system
- Isolated control panel allows safe, convenient operation of baths, rinsers and other process modules
- Whatever the requirements, Terra delivers a pre-configured, tested, turnkey system

These self-contained Wet Processing Cabinets are ideal for a wide range of cleaning and processing requirements.

Standard models below include a reinforced cabinet of the specified size and material, a sliding access shield, and a fluorescent illuminator. Select sinks, baths, etchers and other processing modules to suit your application. A raised lip surrounds the work area to contain spills, and a full-length plenum sink located under the deck contains overflow for easy disposal (select plenum flush for easy cleaning).

A control panel mounted to the side of the deck provides safe, convenient access to all system controls (order processing sinks and baths separately; see pricing and specifications at TerraUniversal.com). Optional Filter/Blower Module provides a vertical laminar flow of HEPA-filtered air for particle-sensitive applications.

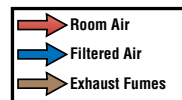
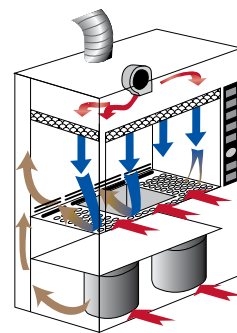

Wet Processing Cabinets (standard height = 72")				Filter Blower Module			Plenum Flush		Ionizing Bar			
Overall Width	Work Area Dimensions	Polypropylene		Stainless Steel		Includes 99.99% Efficient HEPA filter			PVC with H ₂ O Nozzles & Valves			
		Cat. #	\$/Each	Cat. #	\$/Each	115VAC, 60Hz	230VAC, 50Hz	Cat. #	\$/Each	Cat. #	\$/Each	
84"	72"W x 24"D	7018-00	20,782	7018-01	32,788	7018-04	7018-04-220	3,027	7018-50	1,033	2005-37	984
108"	96"W x 24"D	7018-02	24,744	7018-03	37,498	7018-05	7018-05-220	3,655	7018-51	1,192		

Note: All models listed above include an adjustable PVC sliding sash (to restrict airflow to the work area), a static pressure exhaust meter (to monitor the pressure differential in the exhaust line), and a fluorescent illuminator. All electronic controls are located on a vertical panel to the right of the work area (left side mounting may be specified at no extra charge). PLC controllers are also available; call for quotation.

FEATURES and ACCESSORIES



Constant-temperature baths and dump rinsers in quartz, polypropylene, PVDF, 304/316 stainless steel and other high-purity, chemical-resistant materials



Carboys and Reclamation Tanks

FM 4910 and other plastics

PLC automation



Sinks, goosenecks, air/de-ionized water spray guns, aspirators and other utilities



Polypropylene Acid/Base Etching Bench No. 2000-18
(shown with optional processing baths and controls)



Stainless Steel Solvent Cleaning Bench No. 2001-06
(shown with optional sink, gooseneck faucet, spray gun)

MODULAR WET PROCESSING and CLEANING CABINET

- Modular designs accommodate process baths, tanks, goosenecks, aspirators, spray guns, fire detection/suppression systems, and other system options
- Isolated control can be mounted above, behind or to the side of the work deck
- Select Vertical Laminar Flow or Exhaust Fume Workstation to control particles, chemical vapors

Like the models on the previous page, these benches accommodate a complete line of baths, rinsers, cleaners and other processing modules.

Terra engineers work with yours to develop a deck configuration that's right for your process. Bath controls can be mounted to the side or behind the work deck. An overhead control case extends controls forward, above the work deck, for easier operator access. Standard models below include reinforced station with modular deck panels.

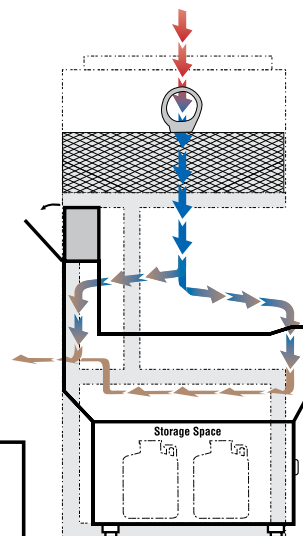

Modular Wet Processing Station*					Vertical Laminar Flow Hood				Plenum Flush	
Overall Width	Work Area Dimensions	Polypropylene		Stainless Steel		Order Filter/Fan Units separately		PVC with DI Water Nozzles		
		Cat. #	\$/Each	Cat. #	\$/Each	115VAC	230VAC	\$/Each	Cat. #	\$/Each
48"	36 x 23	2000-16	7,895.00	2001-04	17,362.00	2004-10	2004-10-220	7,797.00	2001-34	1,112.00
60"	48 x 23	2000-17	9,057.00	2001-05	19,829.00	2004-11	2004-11-220	8,768.00	2001-35	1,272.00
72"	60 x 23	2000-18	11,358.00	2001-06	23,315.00	2004-12	2004-12-220	9,184.00	2001-36	1,430.00
96"	84 x 23	2000-19	13,691.00	2001-07	26,045.00	2001-13	2004-13-220	10,433.00	2001-37	1,589.00

* All models on this chart are designed for rear panel mounting of controllers (as shown in photo above). Call for a quotation on models with head case panel mounts.

FEATURES and ACCESSORIES



Standard models operate with Terra's Vertical Laminar Flow or Exhaust Fume Workstations (see following page)



Configure baths in a single or double row to accommodate workflow



Containment hood collects and condenses vapors



Blue Prices: items usually ship in 1-3 days. Order: 714-578-6000



MADE in the U.S.A.

Vol. 4 No. 15

LAMINAR FLOW STATIONS

BUY ONLINE! Models in stock for next day shipping!

- HEPA/ULPA-filtered enclosure provides a clean, static-safe work environment
- Vertical and horizontal flow stations available with powder-coated or easy-clean stainless steel finish
- Hundreds of standard sizes and configurations, with modifications to handle any application!

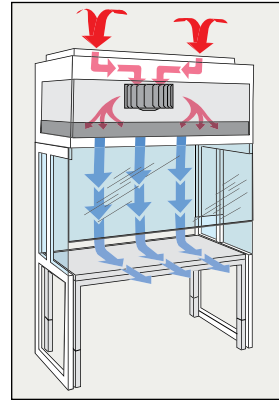

All Fan Filter Units



Vertical Laminar Flow Station, No. 2001-83A, shown with optional cleanroom bench No. 2402-00

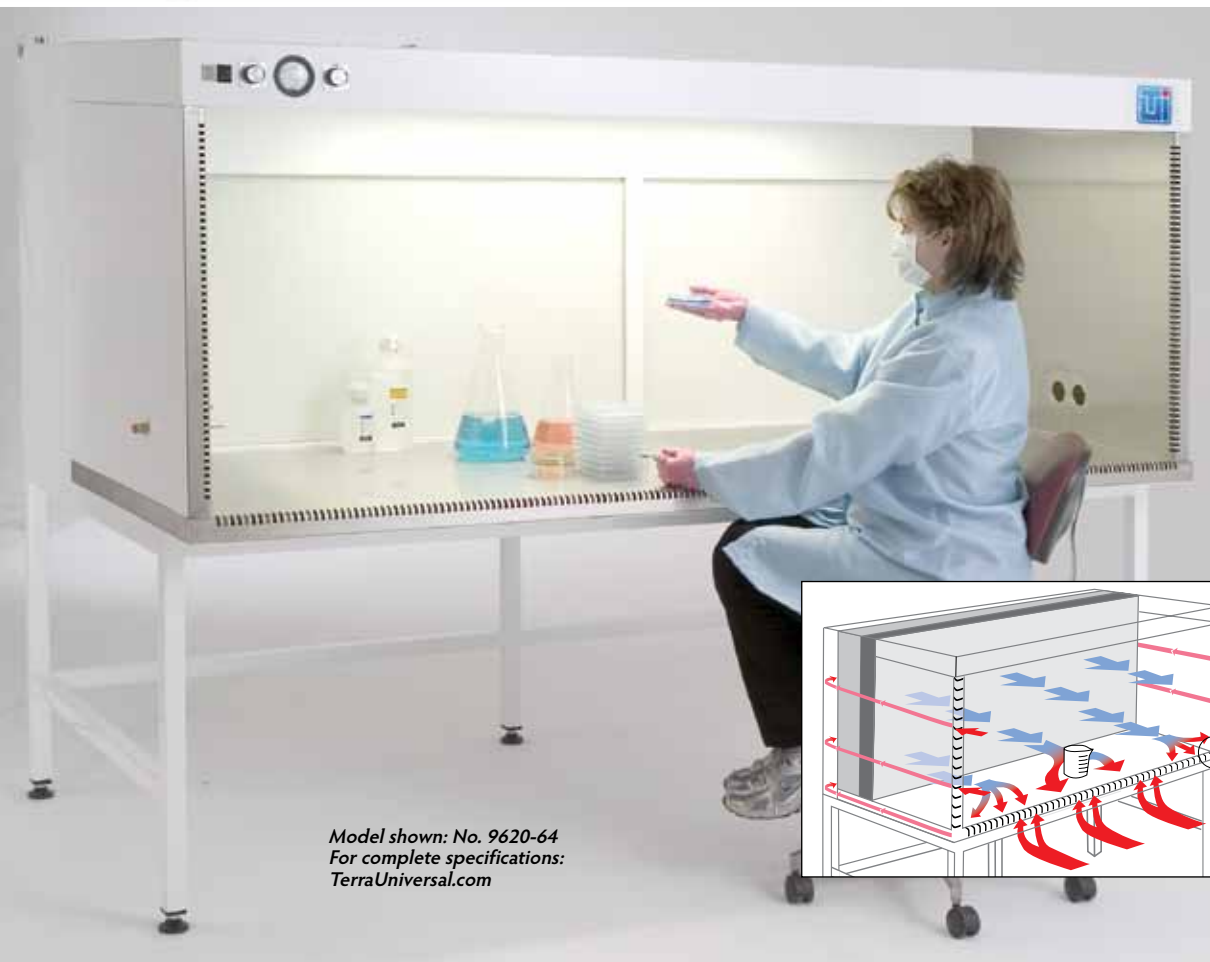

Return air ducts minimize turbulence and backwash

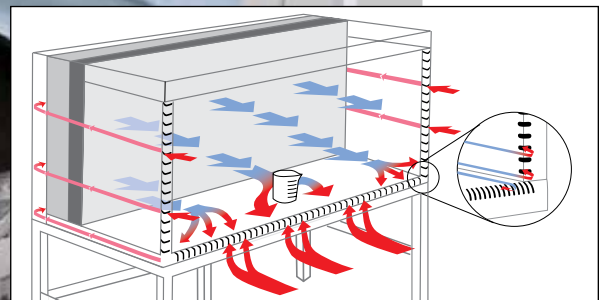

Model shown: No. 9620-64
For complete specifications:
TerraUniversal.com



ValuLine™ Workstation No. 2001-69:
Complete system includes frame, workstation and hood



ValuLine™ WhisperFlow™ Hood No. 1688-40:
Polypropylene HEPA-filtered enclosure under \$2,000

A. ValuLine™ Laminar Flow Workstations

This low-cost, completely integrated workstation includes a powder-coated or stainless steel frame, stainless steel work surface, and laminar flow HEPA filtration module with tilting sash, fluorescent light, and backpressure gauge. Several sizes available, starting at under \$4,500.

B. ValuLine™ WhisperFlow™ Benchtop Laminar Flow Hood

This all-polypropylene laminar flow hood provides a vertical flow of HEPA-filtered air to the work bench. Order desired work surface separately. Integrated polypropylene bottom include raised lip to capture chemical spills. Many sizes available.

C. WhisperFlow™ Bench-Top Hood

This versatile system offers low-noise and vibration (50 dBA) in either horizontal or vertical flow configuration. Select hood of desired material and HEPA or ULPA filter/fan module.

Benchtop Hoods 48"W (36"W models available)

Hood Material*	Cat. #	\$/Each
Vertical Flow		
Acrylic	1686-50C	2,596.00
Static Dissipative PVC	1686-51C	3,389.00
Nondissipative PVC	1686-52C	2,596.00
Stainless Steel (Dissipative PVC)	1686-54C	3,402.00
Horizontal Flow		
Acrylic	1686-55C	2,596.00
Static Dissipative PVC	1686-56C	3,389.00
Nondissipative PVC	1686-57C	2,596.00
Stainless Steel (Dissipative PVC)	1686-59C	3,402.00

* Unless indicated in parentheses, shield is made of the same material as the hood.

Filter/Fan Module	Cat. #	\$/Each
HEPA Filter	6601-24-H	\$740.00
ULPA Filter	6601-24-U	\$845.00



C Horizontal or vertical configurations

Explosion-Proof and Particle Ventilation Configurations also available!

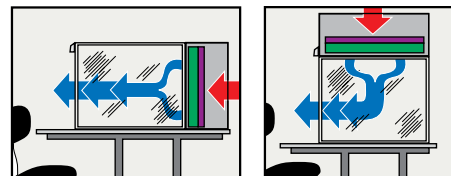

Blue Prices: items usually ship in 1-3 days. Order: 714-578-6000



Vol. 4 No. 15



No. 1694-02B, shown with optional pass-through vacuum oven and low-humidity controllers

Series 300 Stainless Steel Glovebox

The ideal isolation enclosure for a wide range of operations requiring control of particles, humidity, and temperature. Select among several different sizes for one or two operators. Automatic humidity control systems regulate a purge of process gas to maintain user-determined %RH set point. Available in many configurations, with air locks, pass-through ovens, ionization, humidification and sterilization modules.

Perfect for parts degassing, temperature and humidity testing, chemical mixing, and other processes requiring a non-reactive environment.

System starts at \$4,917.00



Air Lock Provides Convenient Access.

No. 1694-13B, shown with optional Dual Purge System and right-side airlock

Series 400 Stainless Steel Glovebox

Like the Series 300 chamber shown at left, this isolation glovebox protects delicate materials against particles, humidity, static discharge, and other environmental threats. Its larger chamber size accommodates bulky process equipment.

Choose between single and twin models, with right or left-side air locks. Custom modifications are available on all Terra gloveboxes; just let us know your requirements!

System starts at \$10,005.00

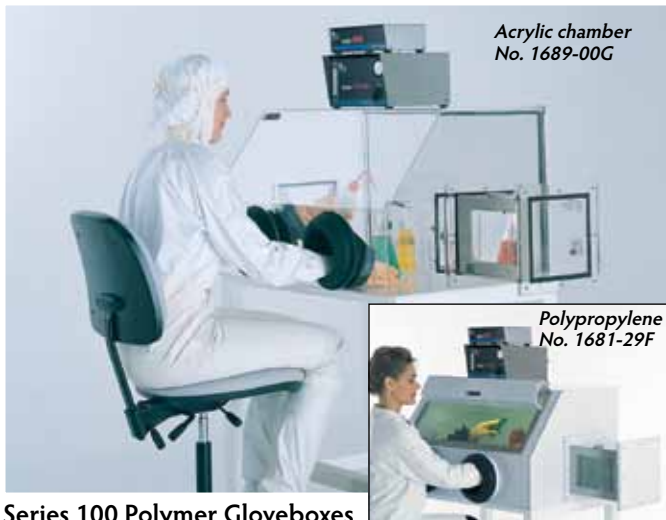

Acrylic chamber No. 1689-00G

Polypropylene No. 1681-29F

Series 100 Polymer Gloveboxes

Terra's Series 100 Polymer Gloveboxes provide a clean, low-humidity environment for critical processing operations. Their modular design lets you select the options you need for your application.

Dual side access doors open inward to allow easy parts transfer from inside the chamber. Doors feature stainless steel reinforcement frames that increase the structural rigidity of the door by a factor of five. A built-in LiftLatch securely seals the door without applying lateral torque that could damage hinges.

Models in stock for next day shipping!

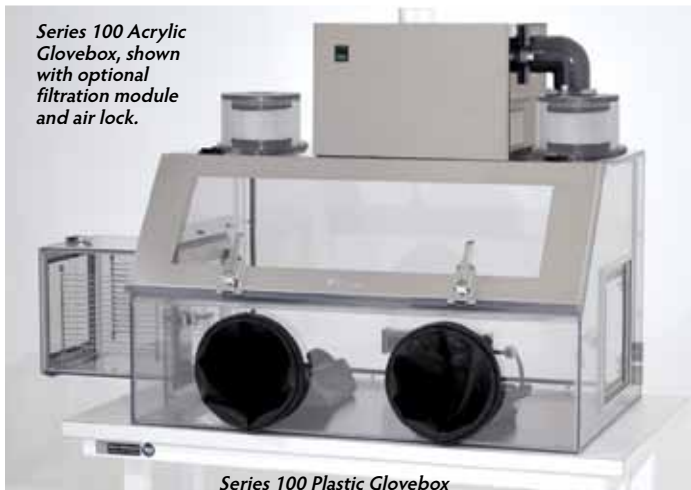

Series 100 Acrylic Glovebox, shown with optional filtration module and air lock.

Series 100 Plastic Glovebox

Series 100 gloveboxes are available in five materials:

- Acrylic** — strong, rigid material offers full visibility
- Static-Dissipative PVC** — protects against static discharge and eliminates static attractions
- Non-Dissipative PVC** — resists a wide range of chemicals, including most disinfectants
- Polypropylene** — ideal for chemical mixing or use with acids
- Polycarbonate** — strong and resistant to chemical and thermal shock

Select among a full range of options for control of particles, static charges, and humidity.

Systems start at \$1,301.00



No. 1694-33A (two linked together)

Series 500 Full-View Glovebox

This enclosure features transparent front and back panels, made of static-dissipative PVC or polycarbonate, with opposing glove ports for convenient dual-side access to work in progress. This design combines full chamber visibility with the strength of a stainless steel glovebox.

It features a large chamber—up to 96" W x 36" D x 30" H—for work with bulky process equipment. Controller systems protect against particles, static charges, and humidity. Terra's smart gas controllers regulate the purge of nitrogen or other process gas to maintain the humidity set point you require.

Systems start at \$5,767.00



No. 9670-00B, shown with right-side air lock

Series 600 Front-View Glovebox

This chamber provides a sloping front panel of transparent polycarbonate or safety glass for full visibility of work in progress. Like the Series 500 model at left, it accommodates Terra's complete line of environmental control systems to automatically maintain a particle-free, controlled-humidity, static-safe environment. Multiple chambers can be cascaded together to expand working space. Standard chamber size: 37.5" W x 29" D x 39" H.

System starts at \$7,389.00



No. 2900-46C

No. 2900-62 ValuLine™ Compounding Aseptic Isolator

Compounding Aseptic Isolator
Complies with USP-797

This laminar flow glovebox provides an easy-to-clean environment for performing sterile pharmaceutical preparations. Its HEPA filtration module provides ISO 5 cleanliness conditions. A separate antechamber allows introduction of materials without contaminating the main work area. Includes polyurethane exit filter. Gloves come in a variety of materials to meet specific user requirements. Dimensions: 50" W x 30" D x 51" H.

Material	Cat. #	S/Each
304 Stainless Steel	2900-46C	7,906.00
ValuLine Polypropylene	2900-62	6,194.00

Available for next-day shipping

Containment isolators also available. See page 47.



Insulated chambers available

BioSafe™ Stainless Steel Glovebox

This glovebox features smooth, ultra-clean interior surfaces that eliminate germ traps, making it ideal for aseptic requirements. Continuous-seam welds and rounded corners create a hermetically sealed enclosure that's easy to clean and sterilize. Tempered glass or polycarbonate viewing windows afford full chamber visibility, and optional side air locks allow convenient parts transfer. Optional access panels are available for transfer of large process equipment. Select between two sizes, with either polycarbonate or safety glass viewing window.

System starts at \$18,514.00

Custom Work is No Problem!
Contact Terra to discuss your unique requirements.



Blue Prices: items usually ship in 1-3 days. Order: 714-578-6000



Vol. 4 No. 15



A. Fiberglass 30 Laboratory Hoods

Made with chemical resistant one-piece fiberglass interior and an epoxy-coated steel exterior, these compact by-pass models maintain stable face velocity, and the pivoting air foil maximizes containment. Available with an integral exhaust blower. Model shown: 3646-48 (30" width).

Cat. # S/Each
3646-48 3,750.00

B. Basic Laboratory Hoods

Ideal for labs requiring light duty applications, the by-pass airflow maintains stable face velocity and vapor-proof or explosion-proof blower models provide safe ventilation. Various system options are available in 47" and 70" widths. Model shown: 3646-00 (47" width).

Cat. # S/Each
3646-00 4,124.00

C. Protector XStream Laboratory Hoods

High-performance, low-volume benchtop models provide maximum containment and energy savings. The patented features significantly reduce contaminants near the user's breathing and behind the sash opening. By-pass models are available in four widths. Model shown: 1538-34 (5' width).

Cat. # Price
1538-34 6,880.00

D. Protector Premier Laboratory Hoods

As the only high performance hood in the market available with a built-in blower, these benchtop models have containment enhancing features and their dimensions match standard lab casework, base cabinets and stands. Available in four widths. Model shown: 3649-04 (4' width).

Cat. # S/Each
3649-04 6,277.00

E. Purifier Logic+ Biological Safety Cabinets

Designed for comfort, safety and efficiency, these Class II, Type A2 cabinets protect user, product and environment from hazardous agents. Available in 4" width 8" or 10" sash openings. Various system options and optional canopy connection to choose from. Model shown: 3642-22 (6' width).

Cat. # S/Each
3642-22 11,543.00

F. Paramount Ductless Enclosures

These self-contained workstations require no ducting to the outside, making them portable and easy to install. An air foil enhances fume containment. Available in 36" and 72" nominal widths with various models, filters and accessories to choose from. Model shown: 3647-06 (36" width).

Cat. # S/Each
3647-06 6,195.00



- SteamScrubber and FlaskScrubber are available in undercounter and freestanding models
- Both models offer flexible cycle options
- All racks are interchangeable among washers and may be purchased separately

Labconco laboratory glassware washers have specialized features to meet the laboratory's demand for superior cleaning and convenience.

The SteamScrubber has top and bottom racks that accommodate accessory inserts for a wide variety of glassware shapes and sizes, primarily beakers and other wide-mouth glassware. The FlaskScrubber has a spindle rack that holds up to 36 pieces of narrow-necked glassware such as volumetric flasks.

Both models have a LCD information center for customizing cycles and monitoring operation, including internal water temperature. These washers require non-foaming detergent.



The SteamScrubber comes with two racks for general purpose laboratory work.

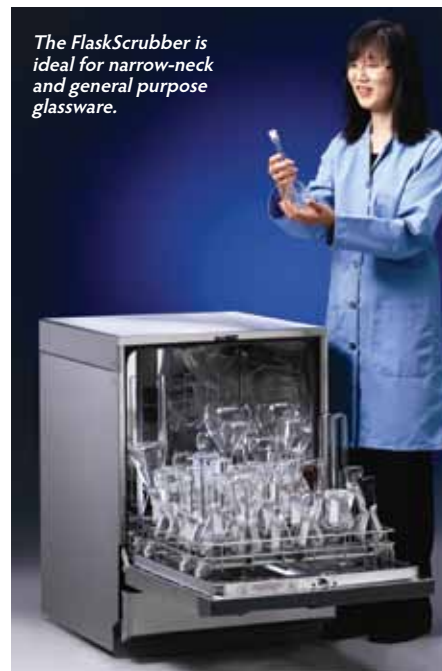

The FlaskScrubber is ideal for narrow-neck and general purpose glassware.

Overall Dimensions W x D x H	Type	Window & Light Available	Power*	SteamScrubber		FlaskScrubber	
				Cat. #	\$/Each	Cat. #	\$/Each
24.1" x 27.4" x 34.1"	Undercounter	No	115V	6921-08A	6,423.00	6921-02A	8,308.00
24.1" x 27.4" x 34.1"	Undercounter	Yes	115V	6921-45	6,902.00	6921-41	8,740.00
24.2" x 27.5" x 34.2"	Freestanding	No	115V	6921-10A	6,637.00	6921-04A	8,481.00
24.2" x 27.5" x 34.2"	Freestanding	Yes	115V	6921-47	7,254.00	6921-43	9,098.00

* Also available in 208/240V

SAMPLE PREPARATION PRODUCTS by Benchmark Scientific



Mortexer™ Vortexer

The Mortexer™ offers variable speed vortex mixing up to 3400 rpm and the power of instant vortexing, even for 50ml sample tubes, with minimum noise and vibration, using touch or continuous operation. The Mortexer™ is cold room and incubator compatible. It comes equipped with a Multi-Head™ with a traditional head for general purpose mixing and holds eight microcentrifuge tubes; other accessories are available—call for details.

115V, 60Hz model below. A 230VAC model is also available.

	Cat. #	\$/ Each
Mortexer™	BR01-00	219.00



MyBlock™ Mini Dry Bath

Benchtop control of sample temperature has never been this easy or economical. The new MyBlock™ Mini fits almost anywhere and can even be used "on-the-go" in cars, boats or wherever a 12 volt power source is available. Its simple touch pad control with digital display is designed for "set and walk away" temperature selection and unrivaled accuracy. At less than 4.4 inches wide, MyBlock™ Mini is truly the first personal block incubator.

	Cat. #	\$/Each
MyBlock™ Mini	BR10-00	189.00
12V vehicle power adapter	BR10-07	32.00



BlotBoy™ and Mini-BlotBoy™ Rockers

These platform rockers provide the perfect 3-dimensional motion for all blot-related applications. Their tilt angle and speed are set for optimal gentle but thorough mixing in gel trays, boxes and other flat vessels. Both models include brushless motors and autoclavable flat mats. They are ideal for blot washes and gel staining/destaining and safe for use in cold rooms and incubators. They accept stackable platforms and handle loads up to 2 kg. Both are 110VAC.

	Cat. #	\$/Each
BlotBoy™ Rocker	BR02-01	371.00
Mini-BlotBoy™ Rocker	BR02-00	335.00



A. ADA-Compatible Refrigerator by Marvel Scientific

Marvel Scientific's ADA compliant refrigerator fits under 34" countertops and may be built into casework with zero clearance or used as free standing. The units are designed to comply with the Americans with Disabilities Act (ADA) for accessibility by adhering to strict height standards.

B. CxF Series -40° C and -86° C Chest Freezers by Revco

The CxF Series Chest Freezers are designed to provide versatile and reliable sample storage. An intuitive microprocessor control panel allows personnel to see set points, system status and alarm messages. A variety of sizes and temperature ranges are available to accommodate most application requirements.

C. UxF Series -86° C Upright Freezers by Revco

The UxF Series freezers provide outstanding sample protection, while maintaining the highest standards in performance, energy efficiency and capacity per footprint. A dual cascade system provides faster recovery after door openings, tighter uniformity, and reduces energy use. A variety of sizes and temperature ranges are available to accommodate most application requirements.

D. Revco Pharmacy Refrigerators by Thermo Scientific

These high-performance pharmacy refrigerators provide stable temperature control over a range of +1°C to +8°C. Easily configured for accurate storage and retrieval of pharmacy products, these units also have full extension stainless steel roll-out drawers, safety glass, double-panel doors and a bright digital temperature display that simplifies operation. Models are available in 11.5, 23.3, 29.2 and 51.1 (shown) cubic feet capacities.

E. Jewett Pass-Thru Refrigerators by Thermo Scientific

Multiple entry points make Jewett Pass-thrus a convenient and reliable choice in the cold storage of non-critical materials in life science, clinical and industrial applications. UL and CE listed units keep uniform temperature and rapid temperature recovery. The triple-pane heated glass doors eliminate condensation and fogging. Materials: powder-coated steel interior; stainless steel exterior. Models in 24.8 cu. ft. (shown) or 55 cu. ft. capacities.

Type		Exterior Dimensions H x W x D (in.)	Temp Range (°C)	Capacity (cu. ft.)	Power**	Cat. #	S/Each	
A.	ADA Compliant Refrigerators	General Purpose	31.5 x 23.875 x 24.375	1° to 7°	5.4	115V	2860-06A	1,169.00
B.	CxF Ultra Low	Chest	43.8 x 28.5 x 29.9	-10° to -40°	3	115V	1536-10	5,641.00
	CxF Ultra Low	Chest	43.8 x 28.5 x 29.9	-50° to -86°	3	115V	1536-14	8,486.00
C.	UxF Ultra Low	Upright	51.23 x 17.78 x 28.29	-50° to -86°	14.9	115V	1536-24	11,661.00
	UxF Ultra Low	Upright	51.23 x 23.13 x 28.29	-50° to -86°	19.4	115V	1536-25	13,182.00
D.	Pharmacy Refrigerator*	Glass Doors	79.2 x 56.5 x 36.4	1° to 8°C	51.1	115V 60Hz	1620-39	8,485.00
E.	Pass-Thru**	Multiple Entry Points	84 x 29 x 36	+2°C to +4°C	24.8	120V/60HZ	3615-09	7,036.00

* Available with glass doors.

** Select models are available in 220V. Visit TerraUniversal.com for more information.



A. Bio-Cane* Cane and Canister Systems

Units are a cost-effective method of storing cells, tissues and other biological samples. Vessels hold samples up to seven months without replenishing liquid nitrogen (LN₂). Capacity sizes: 20L, 34L, 47L, and 70L.

	Cat. #	\$/Each
Bio-Cane 20	4901-08	1,200.00

B – D. Locator Cryogenic Rack and Box Systems

These compact systems are designed for long-term storage and easy retrieval of cell samples. Stores samples below -180°C even when less than 2" (51 mm) of liquid nitrogen remains.

B. Locator Jr. –LN₂ Capacity: 60L

Vial Capacity	Cat. #	\$/Each
1,600	4901-00	3,071.00

C. Locator 8 – LN₂ Capacity: 111L

Image shows a Locator 8 being filled with liquid nitrogen.

Vial Capacity	Cat. #	\$/Each
1,800	4901-02	3,457.00

D. Locator 4 with Level Monitor 120V – LN₂ Capacity: 111L

Safeguards valuable samples with minimal liquid nitrogen evaporation and conduction.

Vial Capacity	Cat. #	\$/Each
3,600	4901-04	4,791.00

E. Liquid Nitrogen Transfer Vessels

Stores and dispenses liquid nitrogen to Locator Systems, these vessels are available in 5L, 10L, 20L and 32L capacities. Lightweight aluminum dewars assure low-static evaporation rates.

	Cat. #	\$/Each
Thermo 5L Capacity	4901-36	863.00



FREEZE DRY SYSTEMS and VACUUM CONCENTRATORS by Labconco



FreeZone® 1 Liter Benchtop Freeze Dry Systems

Ideal for light aqueous sample loads, these units have an upright stainless steel collector coil (removes a max. of 1L of water in 24 hrs.). Features: ¼ hp refrigeration system, LCD display, CFC-free refrigeration system, and corrosion-resistant epoxy coated steel and brushed stainless steel interior.

Cat. #	\$/Each
6922-00	4,226.00



FreeZone® Plus 2.5 Liter Freeze Dry Systems

These units handle light sample loads with low eutectic points (-84° C/-119° F). The upright stainless steel collector coil removes 1.8L of water/24 hrs., and holds 2.5L of ice before defrosting.

Cat. #	\$/Each
3647-80	8,546.00



CentriVap® micro IR Vacuum Concentrators

Compact and portable, this personal-sized concentrator is ideal for DNA samples and small throughput environments. The infrared (IR) glass lid speeds evaporation and reduces cross contamination. Included rotor accommodates 24 small samples and IR strobe light allows sample viewing during operation..

Cat. #	\$/Each
3648-25	5,382.00



Blue Prices: items usually ship in 1–3 days. Order: 714-578-6000



Vol. 4 No. 15

OVENS



Heratherm General Protocol Ovens by Thermo Scientific

Ideal for routine heating and drying up to 250 °C, these energy efficient units come in benchtop or large capacity models. Gravity convection units provide low turbulence heating and drying. Mechanical Convection models provide fast drying of glassware, powders, paper and textile. Select models are CE or cCSAus listed. 120V models listed

Model/Volume (L)	Cat. #	\$/Each
Gravity—66L	3700-87	1,561.00
Mechanical—66L	3700-90	1,821.00



"Squaroid" Vacuum Ovens by Thermo Scientific

These ovens provide a max. temperature of 220°C. Radiant warm-wall heating provides more even chamber temperature, and built-in high-limit thermostat guards against overheating. Models below feature LED temperature readouts and operate at 120VAC; 240VAC and dial thermometer models are also available, as well as high-temperature models.

Chamber Volume	Cat. #	With LED Readout \$/Each
0.7 cu. ft.	3700-80	2,872.00
2.3 cu. ft.	3700-82	4,762.00



Large-Capacity Forced-Air Ovens by Sheldon Manufacturing

These versatile multi-purpose ovens create true one-pass circulation pattern for optimal uniformity and fast recovery time. Includes an electronic digital timer with large LED display and overtemperature protection and isolated heating elements. Chamber interior is stainless steel. Models shown are 120VAC.

Chamber Size	Cat. #	\$/Each
14.0 cu. ft.	3700-85	4,140.00
28.0 cu. ft.	3700-86	4,693.00

INCUBATORS



myTemp™ Mini Digital Incubators by Benchmark Scientific

Compact with a lot of power, the myTemp packs 20 liters of capacity in Heat Only or Heat and Cool models that accommodate bottles and flasks up to 2L. Other features include a vibrant LED control panel, a carrying handle and two adjustable shelves.

	Cat. #	\$/Each
myTemp™ H Heat Only	BR18-00	378.00
myTemp™ HC Heat & Cool	BR18-01	561.00



Midi 40 Small Capacity CO₂ Incubators by Thermo Scientific

Designed specifically for cell culture scientists working within a limited space, the Midi 40 CO₂ Incubator delivers what bigger incubators do at a cost-effective price point. These compact units store up to 35 T75 culture flasks and they feature a comprehensive alarm system. Features: benchtop, stainless steel chamber and cabinet, and 1.4 cu. ft. capacity includes four stainless steel drawers.

	Cat. #	\$/Each
120 V 60 HZ	3615-78	4,314.00
1230 V 50/60 HZ	3615-79	4,416.00



Direct Heat CO₂ High-Capacity Incubators by Thermo Scientific

These dependable high-capacity incubators feature convenient direct heat temperature control technology and advanced chamber insulation in a stackable design. They are configurable with infrared (IR) or thermal (TC) gas sensors and 6.5 cu. ft. stainless steel (SS) or solid copper chambers.

115VAC and 230VAC models available.

	Cat. #	\$/Each
SS chamber w/ TC sensor	1799-00	5,629.00
SS chamber w/ IR sensor	1799-02	6,634.00
Copper chamber w/ TC sensor	1799-04	6,444.00
Copper chamber w/ IR sensor	1799-06	6,906.00



Oasis CO₂/O₂ Incubators
by Caron Products

This compact, stackable unit saves lab work space while providing intuitive operation and precise control. A highly reliable IR sensor ensures quick recovery after the door is opened, and a tri-zone temperature control system enhances heating efficiency and uniformity. A decon system cleans the incubator overnight. Temperature range: 5° above ambient to 60°C. Capacity: 10 cu. ft. Power: 115VAC (230VAC models available)

Type	Cat. #	S/Each
CO ₂	5757-25	5,616.00
CO ₂ /O ₂	5757-31	8,160.00



Reach-In CO₂ Incubator
by Caron Products

This series provides the perfect conditions for high-volume cell culture. Control parameters and uniformity rival any conventional incubator. A drift-resistant RTD sensor provides precise temperature control from 10° above ambient to 60°C. Power: 115VAC (230VAC and other temperature models available).

Capacity	Cat. #	S/Each
25 cu. ft.	5757-22	12,896.00
33 cu. ft.	5757-29	15,661.00



Environmental Chambers
by Caron Products

Microprocessor-controlled chambers provide precise control over environmental conditions for repeatable results. **Refrigerated Incubators** provide precise temperature control from 5°C to 60°C. **Stability Chambers** add a relative humidity system with solid-state humidity sensor and controller that allow humidification and dehumidification for operation from 20% to 98% RH. All incorporate environmentally friendly HFC refrigerant and CFC-free insulation. Light packages and chart recorders are optional.

Models below are 115VAC; 230VAC also available.

10 Cubic-Foot Capacity	Cat. #	S/Each
Refrigerated Incubator	5757-03	12,047.00
Stability Chamber	5757-05	15,694.00

HOT PLATES



Hot Plates
by Benchmark Scientific

Made with durable, chemical resistant white ceramic top plate, these hot plates are ideal for use inside bio-hoods and crowded benchtops. Advanced microprocessor controls with turn knobs provide precise adjustments and maintenance of heating and mixing. Units are compatible with various sizes of borosilicate glass beakers, flasks, and bottles. Surface dimension: 7.5" x 7.5" with an 8" x 9" footprint.

115V, 50/60Hz	Cat. #	S/Each
	BR05-01	211.00

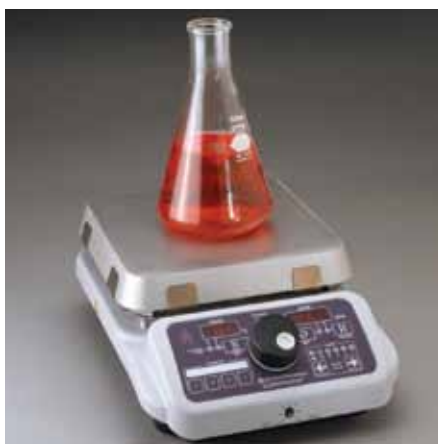

Super-Nuova®
Digital Hot Plates/Stirrers
by Thermo Fisher Scientific

Premium aluminum-top stirring hot plates provide precise digital control of top plate and solution temperatures in 1° increments. Four user-presets call up often-repeated procedures. Magnetic stir bar provides vortex motion to evenly disperse solution and/or heat. Heating surface: 7" x 7". Ceramic top models are also available.

110V Stirring Hot Plate	Cat. #	S/Each
	4100-07	951.00



Explosion-Proof Hot Plate
by Thermo Scientific

This corrosion-resistant, easy-to-clean unit is specifically designed to ensure safe heating in potentially explosive situations. The cast-aluminum top plate provides effective heat transfer, and all controls are contained in an aluminum housing, protected from the explosive atmosphere. Heating surface: 6" x 6". Temperature range: to 220°C (428°F). UL-listed for Class 1 and Group D.

Hot Plate	Cat. #	S/Each
	4000-92	1,043.00



Blue Prices: items usually ship in 1-3 days. Order: 714-578-6000



Vol. 4 No. 15



Heraeus Multifuge X1

As the only 1-liter centrifuge capable of spinning 14 x 50 ml conical tubes in angle configuration at over 12000 xg, the energy saving Multifuge X1 accepts various swinging bucket, fixed-angle and lightweight carbon fiber rotors. Features: 3-second rotor exchange; biocontainment solution; powersave; auto-correct detection.

Select models are UL, CE, or CSA certified; Max Speed: 15,200 rpm (depending on rotor); Max RCF: 25,000 to 25,999 x g; Dimensions: 17.3W x 23.8D x 14.2H in. (Ventilated)/ 24.5W x 23.8L x 14.2H in. (Refrigerated).

	Cat. #	S/Each
Ventilated	1538-52	4,773.00
Refrigerated	1538-54	6,692.00



Heraeus Multifuge X3

With nearly twice the capacity for standard tubes compared to same-sized centrifuges, the energy saving, 3-liter Multifuge X3 is ideal for high throughput environments. Units accept a wide range of rotors. Features: 3-second rotor exchange; biocontainment solution; powersave; auto-correct detection.

Select models are UL, CE, or CSA certified; Max Speed: 6000 to 15200 rpm; Max RCF: 7164 to 25314; Dimensions: 22.2 x 26.4 x 14.2 in. (Ventilated)/ 29.3 x 26.4 x 14.2 in. (Refrigerated). Available in benchtop and floor models.

	Cat. #	S/Each
Ventilated	3618-71	6,920.00
Refrigerated	3618-73	9,182.00
Floor Standing Models		
Ventilated	3618-75	8,061.00
Refrigerated	3618-77	10,146.00



Heraeus Primo/Primo R Centrifuge

Three Centrifuges in one! Ventilated and refrigerated models have the functionality of microliter, high speed and general centrifuges. These centrifuges can accommodate swinging bucket rotors, fixed-angle rotors and microliter rotors. The Heraeus Primo series is equipped with electronic imbalance recognition. (Ventilated Model Shown.)

CSA Certified; Max. Speed/RCF: 15,000rpm/21,885x g; 400 mL Capacity; Dimensions: Ventilated, 5 x 16.7 x 12.4 in. (380 x 475 x 315 mm); Refrigerated, 22.8 x 15.3 x 12.3 in. (580 x 493 x 313 mm).

	Cat. #	S/Each
120V, 60Hz Ventilated	1799-44	2,949.00
Refrigerated	1799-45	5,116.00



Heraeus Clinifuge Centrifuge

Ideal for clinical blood sample processing in small labs and medical practices, the Heraeus Clinifuge is also an excellent standby unit for larger labs. The unit protects against user error by displaying faults and accepts a wide range of adapters. Rotor chambers are completely sealed during centrifugation and the brushless motor eliminates carbon brush replacement purchases. Autoclavable rotor is easy to remove and clean. This centrifuge is also able to self-diagnose by detecting and displaying faults.

CSA Certified; Capacity: 12 x 15mL; Max Speed: 5000rpm; Max RCF: 2600 x g.

	Cat. #	S/Each
120V, 60Hz	1798-58	1,547.00



MyFuge™ Mini

This personal centrifuge is small and silent, but powerful. The rotor instantly reaches 6,000 rpm once the lid is closed and quickly stops once the lid is open. Ideal for quick spin downs of microtubes and PCR tubes. The unit comes with an installed eight position microtube rotor and the second PCR 0.2 ml rotor is conveniently stored in the bottom compartment.

Color	Cat. #	S/Each
Red	BR04-05	214.00
Blue	BR04-06	214.00
Clear	BR04-07	214.00
Green	BR04-08	214.00
Purple	BR04-09	214.00

CENTRIFUGES by Benchmark Scientific



MyFuge™ 12 MiniCentrifuge

The convenient low profile design of the MyFuge 12 features the COMBI-Rotor™, which eliminates the need to change rotors when switching between microtubes and PCR strips. With twice the capacity of most mini centrifuges, silent operation and the quick start and stop action by just opening and closing the lid, the MyFuge 12 is an ideal personal centrifuge or as an additional unit to any laboratory.

Capacity: 12 x 15/2.0ml tubes; 32 x 0.2ml tubes; 4 x PCR strips (8x0.2ml) Speed Range: 5,500rpm/2,000xg; Dimensions: 5.5" x 7.9" x 4.4" (140 x 201 x 112 mm).

	Cat. #	S/Each
115V, 60Hz	BR15-00	307.00
230V, 60Hz	BR15-01	307.00



MaxQ 5000 by Thermo Scientific
Foot pedal-operated shaker comes in analog and digital models

Perfect for cell cultures, solubility studies, extraction procedures and more.

	Cat. #	S/Each
Analog	5322-18	7,464.00



MaxQ 4450 Orbital Shaker by Thermo Scientific
Combines incubated/refrigerated temperatures

Analog or digital, the unit fulfills a variety of molecular biology, cell culture, and dissolution study purposes.

	Cat. #	S/Each
Analog	5322-02	3,099.00



MaxQ 2000 by Thermo Scientific
Analog or digital units use triple eccentric drive to ensure smooth, uniform agitation

Operate in continuous or timed mode for applications including cell cultures, bacterial suspensions, solubility studies, staining, and hybridization.

	Cat. #	S/Each
Analog	5322-00	1,225.00



Incu-Shaker 10L by Benchmark Scientific
Magnetic platform and clamps for easy shake and change of various size flasks

Ideal for busy labs, this quiet, heavy duty unit provides temperature accuracy and uniformity, reduces separation and it includes an optional shelf.

	Cat. #	S/Each
10L	BR13-00	4,396.00
10L (Ref.)	BR13-29	6,771.00
Mini	BR13-02	2,284.00



Orbi-Shaker™ Orbital Shaker by Benchmark Scientific
Powerful motor drive able to shake a 14 lb. load at up to 300 rpm

The optional MAGic Clamp platform (14" x 12") makes it easy to shake and change flasks and racks. The non-slip, rubber coated surface provides extra protection.

	Cat. #	S/Each
115V	BR09-12	1,188.00
MAGicClamp™ Platform	BR09-09	192.00



Multi-Therm™ Vortexer by Benchmark Scientific

Ideal for molecular biology applications, this 8" x 11" vortexer is compatible with many popular tubes and plates. Heat/cool or Heat models are available in 115V and 230V.

115V	Cat. #	S/Each
Heat/Cool	BR14-02	2,108.00
Heat	BR14-00	1,580.00

WATER SYSTEMS: DI and RO – COMPLETE SPECS AT TERRAUNIVERSAL.COM



Barnstead MicroPure by Thermo Scientific

These ultrapure water systems provide 15 liters per day of Type 1 water for molecular biology, microbiology, and analytical chemistry laboratories.

	Cat. #	S/Each
Analytical and UV System	3614-91	3,342.00
UV-ST System	3614-96	3,584.00



Barnstead GenPure Water Purification Systems by Thermo Scientific

Produces up to 200L/day of GLP-Compliant Type 1 ultrapure water. Able to mix and match UF, UV and TOC systems for user specific water purity levels, GenPure models are ideal for use in life sciences and analytical chemistry.

	Cat. #	S/Each
GenPure	1714-32	5,000.00
GenPure UF	1714-33	5,452.00



LabTower TII Water Purification System by Thermo Scientific
Produces and stores GLP-Compliant Type 2 water

This standalone unit with casters has an integrated 100L tank that recirculates reservoir water to preserve purity even during periods of stagnation.

	Cat. #	S/Each
20L/hour	1108-50	8,834.00
40L/hour	1108-53	10,323.00



Blue Prices: items usually ship in 1-3 days. Order: 714-578-6000



Vol. 4 No. 15

ANALYTICAL BALANCES by Sartorius



Practum® Analytical Balances

Foolproof with rugged weigh cell for reliable results, the Practum is ideal for busy labs and new operators. These units feature: sturdy draft shield, menu-lock, touchscreen, easy data transfer, weighing port, overload protection and level indicator. Dimensions: 8.5"W x 14.1"D x 12.6"H.

Weighing Capacity	Cat. #	S/Each
120 g	5701-18	1,356.00
220 g	5701-17	1,994.00



Quintix® Analytical Balances

Built-in applications, intuitive operating design and extensive accessories in the Quintix allow users to customize settings to achieve their desired weight measurement tasks easily, reliably and efficiently. Dimensions: 8.5"W x 14.1"D x 12.6"H.

Weighing Capacity	Cat. #	S/Each
120 g	5702-01	2,250.00
220 g	5702-02	2,588.00

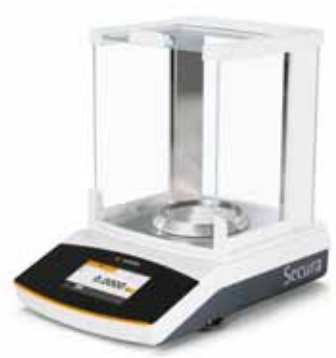

Secura® Analytical Balances

Ideal for use in pharmaceutical weighing applications, the Secura features Advanced Pharma Compliance, LevelControl, and USP Minimum sample weight measurement to ensure the precision and quality of measurements in regulated areas. Dimensions: 8.5"W x 14.1"D x 12.6"H.

Weighing Capacity	Cat. #	S/Each
120 g	5702-03	2,844.00
220 g	5702-04	3,210.00



Cubis MSA2255-000-DM Semi Micro-Balance

The unique built in "NICE" (Neutralization by Ionic Charge Elimination) static eliminator neutralizes electrostatic charges on the samples.

Cat. #	S/Each
5701-04	9,255.00

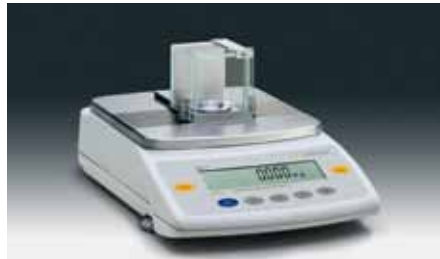

Cubis MSA3.6P Micro-Balance

Micro-balances combine speed, weighing sensitivity, and precision. This unit offers PolyRange weighing with readability to 0.002 mg and weighing capacity down to 0.5 g. Repeatability: ≤ 0.001 mg. Response time: ≤ 10 seconds.

Cat. #	S/Each
5701-02	16,524.00

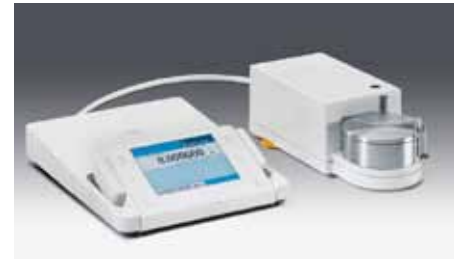

Cubis MSA6.6S Micro-Balance

These micro-balances feature SQ_{min} minimal sample weight function for US Pharmacopeia compliance. Readability to 0.1 µg. Weighing capacity down to 6.1 g. Repeatability: ≤ 1.0 µg. Response time: 10 seconds.

Cat. #	S/Each
5701-01	21,284.00

THERMAL CYCLER by Benchmark Scientific



TC9639 Thermal Cycler

Ideal for medium to high throughput laboratories, the **TC9636** Thermal Cycler makes it quick and easy for users to set up programs and protocols. The large, **full color touch screen** allows the creation of icons for most used programs. The **program wizard** guides users through protocol set-up in a single screen and allows for program edits and alphanumeric naming of programs and folders. Condensation and evaporation of samples are prevented by the **fully adjustable heated lid**. Units also feature programmable lid temperature and the lid automatically shuts off when the block temperature is below 35°C. A proprietary algorithm with tight tolerances accurately controls heating and cooling of the block. The **multi-format block** of the TC9636 eliminates the expense and need for multiple interchangeable blocks and the model accepts 96 x 0.2ml tubes, a 96 well plate or 39 x 0.5ml tubes. For high-throughput labs, the **T5000-384** with 384-well block is available.

	Cat. #	S/Each
TC9639 US plug	BR19-43	3,776.00
TC9639 EU plug	BR19-44	3,776.00
T5000-384 US plug	BR19-46	4,196.00
T5000-384 EU plug	BR19-47	4,196.00

Provides consistent and reliable results with unlimited program storage capability



46.5" work area.
Ideal for USP-797 containment requirements.



33" work area.
CAI units meet hospital pharmacy and cleanroom USP 797 compliance.

LFGI Laminar Flow Glovebox/Isolator

With positive and negative configuration options, the LFGI Series provides ultimate product and operator protection. The ergonomic glove system and the HEPA filters provide the highest level of protection from microbiological particulates, dust, powders and aerosols. Units function as a **CAIC** and **CAI**.

Available in three sizes. Models meet or exceed ISO 14644-1 for Class 5 air quality.

Work Area Width	Cat. #	\$/Each
34.5"	5607-15	18,550.00
46.5"	5607-16	21,241.00
70.5"	5607-17	26,342.00

VersaFlow Laminar Flow Compounding Aseptic Isolator

Constructed of high quality, all-welded stainless steel with pharmaceutical grade finish, this Compounding Aseptic Isolator (**CAI**) meets USP 797 regulations. The work area is bathed with unidirectional HEPA-filtered air with minimal turbulence for a sterile work environment. Units meet or exceed ISO 14644-1 Class 5 air quality and are designed to fit through standard door and elevator openings.

Available in 33", 49" and 55" work area dimensions with a fully adjustable shelf and a stainless steel stand with locking cleanroom grade casters.

System starts at \$13,070.00



48" work area.
Unit optimized for user protection when processing radioactive preps.



34" work area.
Compounding Aseptic Containment Isolator (CACI) completely shields users from radioactive material.

Radiopharmacy Hood

The **RADIOSAFE** Series is a Class II, Type A or A2 Biological Safety Cabinet that meets all requirements for USP 797 compliance to safely handle potentially hazardous materials. Units provide ISO Class 5/Class 100 HEPA filtered unidirectional vertical airflow and incorporates a 3/4" lead shield for protection during compounding radiopharmaceuticals.

Work area dimensions are 50" W X 27" D X 94" H and units are constructed from 100% stainless steel.

Contact a Terra expert for your custom quote.

Radiopharmacy Isolator

Choose the LFGI Series Radiopharmacy Isolator for advanced user and product protection with 1/4" lead shielding when compounding sterile radiopharmaceuticals. Units achieve USP 797 compliance without the need for costly pharmacy ventilation renovations. ISO 14644-1 Class 5 (Class 100) air quality is maintained under dynamic conditions with unidirectional laminar airflow system.

Overall dimensions are 36" W x 34" D x 79.5" H and **CACI** units are constructed from 100% stainless steel interior and exterior with a pharmaceutical grade #4 finish. Units are designed to fit through standard door openings and elevators.

Systems start at \$45,533.00



Blue Prices: items usually ship in 1-3 days. Order: 714-578-6000



Vol. 4 No. 15



Thousands of Items in Stock

Popular models of both Terra-built and distributed products are inventoried for quick shipment – look for blue prices at TerraUniversal.com



Order and Quote Carts



Items priced
in blue usually
ship in 1-3 days.

Online ordering requests for hundreds of stocked items ready for immediate shipping

Online quote requests for made-to-order and custom products,



Low-Cost Domestic and International Shipping

Competitive quotes include customs brokerage and duties for door-to-door delivery



Hassle-Free Pricing

Web prices honored worldwide



Comprehensive Product Lines



Terra provides single-source convenience at remarkable savings. Complete lines of laboratory products at Laboratory-Equipment.com



Global Network of Sales Representatives

Complete listing at TerraUniversal.com



On thousands of items—
Visit Laboratory-Equipment.com