

GLOVEBOXES+



Low-Cost Solutions for High Technology

SAMPLE APPLICATIONS

Isolation

These chambers protect sensitive samples from environmental contaminants, using standard components for economical configuration. More information at TerraUniversal.com.



System shown: No. 1695-01

Photoresist Deposition Isolator

Provides a clean, moisture-free environment for applying photoresist. HEPA filtration module maintains ISO 10 particle conditions, and high-volume gas mixer provides process gas purge that maintains 5-10%RH. The bottom plenum includes cooling coils to ensure a constant temperature of 68°F. Fits most wafer spinners used in the deposition process. Radius corners facilitate cleaning.

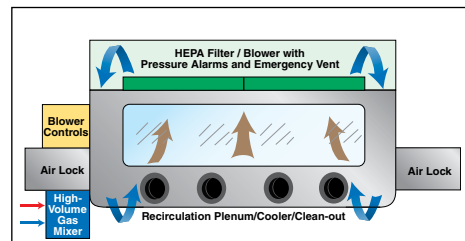

System shown: No. 1695-03. See page 17 for standard models.

Protein Analysis Isolator

A refrigeration unit and nitrogen purge system facilitate protein analysis of meat samples in an inert gas environment down to -20°C. The 304 stainless steel chamber features double-wall construction with 4" of polyurethane insulation for optimal thermal efficiency. A microscope bellows is included.

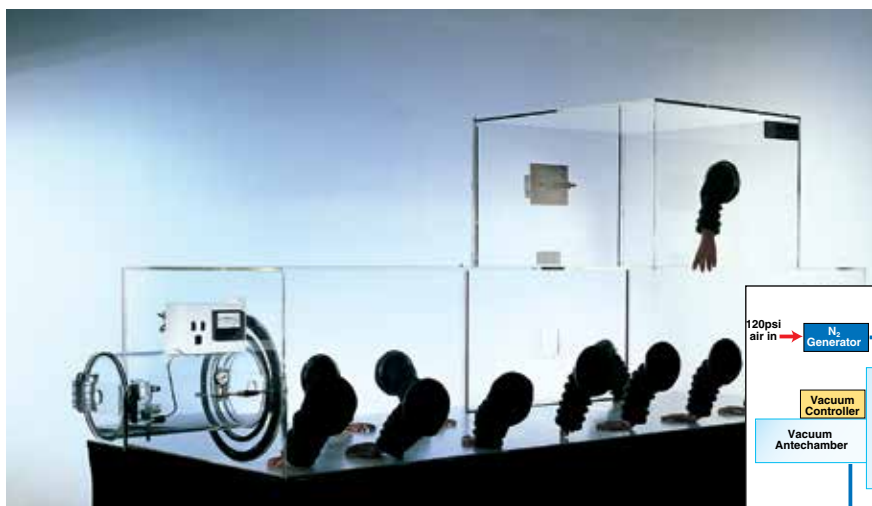
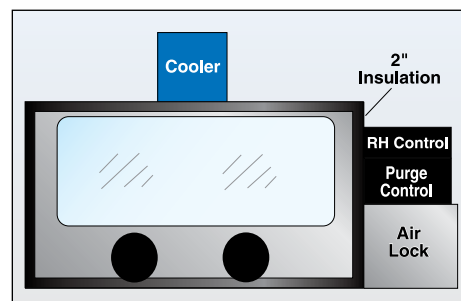

System shown: No. 1695-11.

RF Sealing Isolator

Custom designed for transfer of delicate museum artifacts, including manuscripts, fossils and other fragile specimens, to an acrylic sealing chamber, where an RF sealer preserves them. Vacuum antechambers dry samples before introduction to the isolator, and nitrogen purge controls maintain 10%RH.

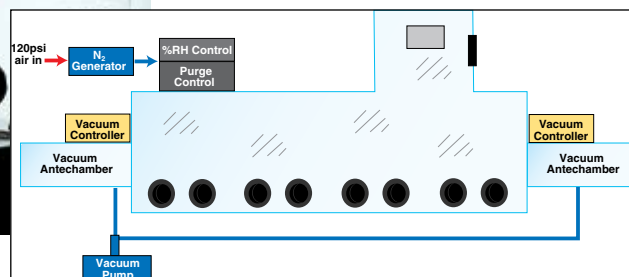

Meteorite Glove Box Isolator

This 304 Stainless Steel chamber is configured for processing meteorite samples in a low-particle, low-humidity environment. Each system consists of two glove boxes linked by a pass-through air lock, which allows transfer of samples without affecting low RH levels in either chamber. Stainless steel glove ports with hypalon gloves allow manipulation of samples, and stainless steel shelves allow organized sample storage.



System shown: No. 1695-16

Material Stress Testing Isolator

Designed for accelerated-life testing of elastomers, fiber composites and other materials over a broad temperature (-20° to +140°F) and humidity (5 to 95% RH). Double-wall stainless steel construction with polyurethane insulation enhances temperature stability and energy efficiency. A pass-through oven allows degassing at up to 300°C.

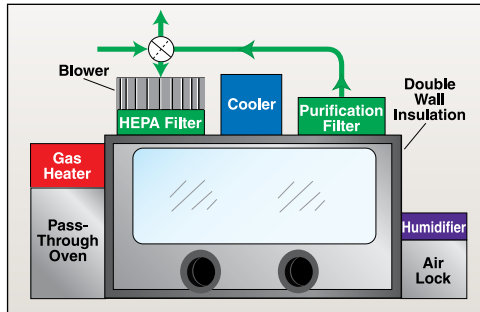

System shown: No. 1695-02

High-Throughput Processing Chamber

Ideal for electronics testing and assembly, this nitrogen-purged isolator accommodates up to six operators working at individual test/assembly stations. Samples are passed from station to station and removed via an air lock, which minimizes disruption of internal cleanliness and low-humidity conditions.

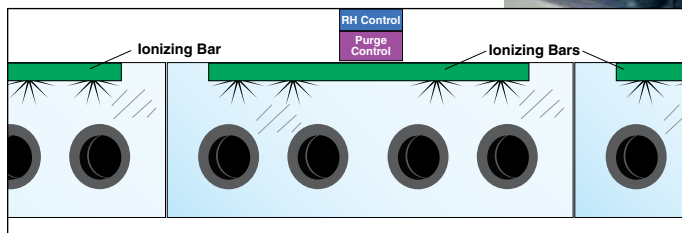

System shown: No. 1695-15

SAMPLE APPLICATIONS

Containment

These chambers contain potential hazards to protect the operator and environment, while also shielding samples from environmental contaminants. More information at TerraUniversal.com.



System shown: No. 1695-10

Radioactive Isotope Containment Chamber

This 12-gauge stainless steel glove box is designed for safe handling of isotopes processed in medical applications. It features two chambers connected by a vacuum port. A counterbalanced bag-in, bag-out transfer hatch ensures a low leak rate of 0.5% of the volume of the total enclosure per hour, and radius corners allow easy cleaning and sterilizing.



Radius corners simplify cleaning, eliminate seams and cracks



System shown: Cat. No. 1695-17

Anaerobic Test Chamber

Designed for drug efficacy and dosing studies of extremely drug-resistant (XDR) TB strains in anaerobic environments, this chamber maintains an oxygen concentration down to 0.1% at a selected temperature. PLC-controlled interlocks and rapid purging antechambers allow transfer of test samples without disturbing the internal environment.

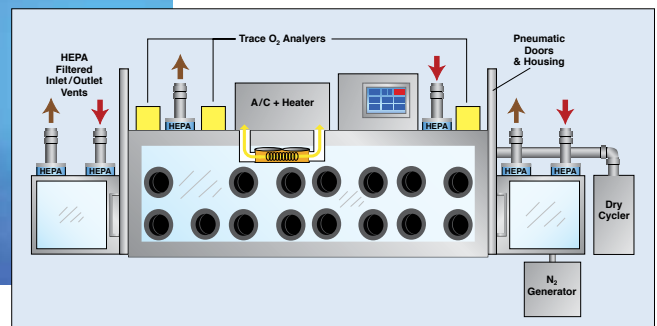

System shown: No. 1695-18

Pharmaceutical Mixing/Packaging Isolator

This static-dissipative PVC chamber accommodates introduction of drug powders via a hopper interface. A mixing/packaging station is installed inside the low-humidity, static-safe environment, and Ultra-Low Penetration Air (ULPA) filters continuously scrub the process environment to remove potentially hazardous airborne powders. Dual-side air locks allow sample transfer.

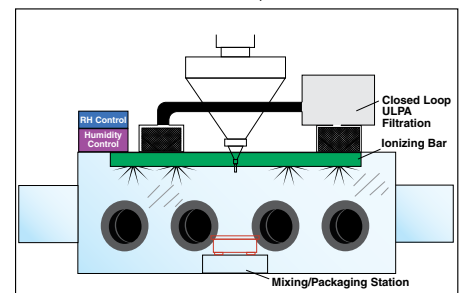

Carbon Monoxide Sensor Calibration Glove Box

Potentially lethal CO gas is fed into a large stainless steel chamber at precise concentrations to allow accurate sensor calibration. A gas mixing system maintains a CO/air ratio, and a Humex™ humidifier raises the moisture to 95% RH. A process gas heater and cooler maintain the stable process temperature of 120°F. A safety ventilation system exhausts process gas in an emergency.

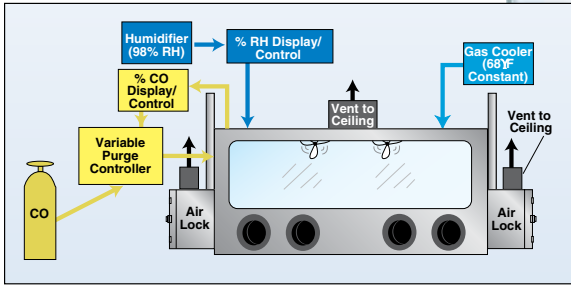

Pneumatic door air locks — see page 28

Model shown: No. 1695-08

Stable Temperature/Humidity Containment Glove Box

This chamber safely contains potential biohazards while providing a stable environment over a broad temperature range (-2 to +36°C) tested at various humidity levels between 0 and 75% RH. The chamber includes a bag in/bag out port for transferring waste, and a large swing-up access door for easy cleaning and transfer of large equipment.

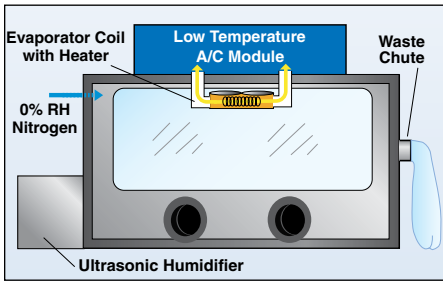

System shown: No. 1695-10

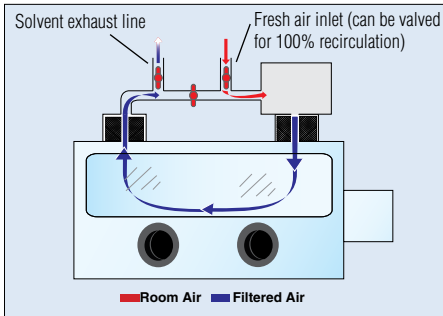

Medical Nano-fiber Processing Chamber

This containment chamber facilitates evaporation of volatile solvents used in the processing of nano-fibers for medical applications such as organ components, tissue engineering, and drug delivery. Common processes require low humidity (down to 5% RH) in a chamber that must resist corrosive solvents and provide a safe exhaust line for vapor removal. Dry process gas is micro-filtered to remove contaminants.



Model shown: No 1695-19



No. 3305-00G

All models shown with optional air locks.

BASIC RESEARCH AND PROCESSING GLOVE BOXES

- Economical processing chambers for laboratory applications requiring a clean, low-humidity environment – *in stock for immediate shipping!*
- Select single or twin sizes in your choice of four application-specific materials
- Optional air locks prevent cross-contamination during parts transfer

BUY ONLINE! Items priced in blue usually ship in 1-3 days.

These low-cost isolation chambers are designed for performance and versatility. All models come with a removable back panel for installing large process equipment. Select optional desiccant or flowmeter for nitrogen purging.

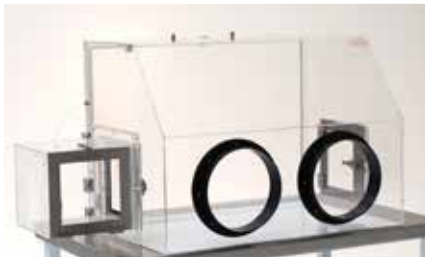

No. 1689-00H (Single Acrylic)



No. 1681-29H (Single Polypropylene)



No. 3305-10G (Twin SDPVC)



No. 1681-31H (Single Polycarbonate)



No. 3305-00G (Single SDPVC)



No. 1681-30H (Twin Polypropylene)

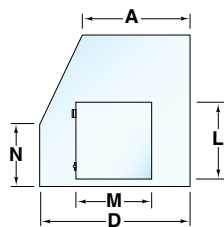
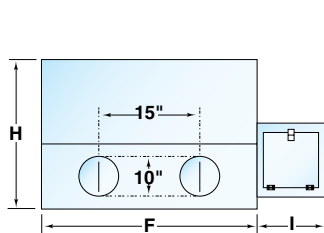

| Nominal Dimensions (inches) | | | | | | | | |
|-----------------------------|-------|----|----|----|------|----|----|----|
| Type | A | D | F | H | I | L | M | N |
| Single | 16.75 | 24 | 35 | 25 | 10.5 | 10 | 10 | 14 |
| Twin | 16.75 | 24 | 59 | 25 | 10.5 | 10 | 10 | 14 |

Low-cost performance available for next-day delivery! See page 12 for models with automatic humidity set-point capability.

Basic Research and Processing Glove Boxes

| Material | Single | | Twin | | Air Lock* | |
|------------------------|----------|----------|----------|----------|-----------|---------|
| | Cat. # | \$/Each | Cat. # | \$/Each | Cat. # | \$/Each |
| Acrylic | 1689-00H | 1,188.00 | 1689-16H | 1,533.00 | 1680-78B | 446.00 |
| Static-Dissipative PVC | 3305-00G | 2,093.00 | 3305-10G | 2,876.00 | 1680-81B | 612.00 |
| Polypropylene | 1681-29H | 1,525.00 | 1681-30H | 1,764.00 | 1680-87B | 495.00 |
| Polycarbonate | 1681-31H | 1,485.00 | 1681-32H | 1,834.00 | 1680-90B | 557.00 |

*See facing page for other options. Standard air lock mounting is on right side of chamber.

VALULINE™ PORTABLE GLOVE BOXES

- Cleanliness and moisture control at a lower cost for small, benchtop requirements – in stock for immediate shipping!
- Select among three application-specific materials
- Air locks and tilt-up windows allow convenient parts transfer

BUY ONLINE! Items priced in blue usually ship in 1-3 days.

These ValuLine Glove Boxes are ideal for processing small parts in a clean, particle-free environment. All models come with a removable back panel, a tilt-up window, and right-side air lock, as well as flowmeter port and installed Automatic RB Valves to accommodate a nitrogen purge (select flowmeter separately).

Select gloves on page 30.



No. 3308-53 (air lock included)

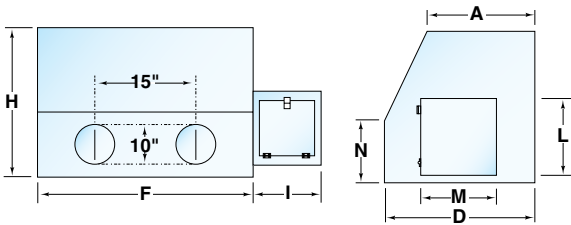

Nominal Dimensions (inches)

| Type | A | D | F | H | I | L | M | N |
|--------|-------|----|----|----|------|----|----|-------|
| Single | 12.75 | 20 | 26 | 18 | 11.5 | 10 | 10 | 11.75 |



No. 3308-51 (Single Acrylic)

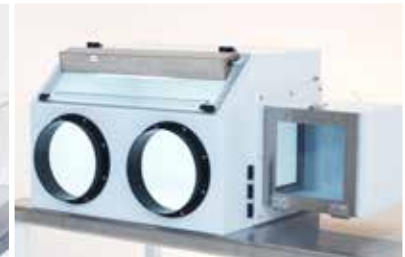

No. 3308-55 (Single Polypropylene)

| ValuLine Portable Glove Boxes | | Single | |
|-------------------------------|----------------|--------|-----------------|
| Material | Cat. # | | \$/Each |
| Acrylic | 3308-51 | | 1,445.00 |
| Static-Dissipative PVC | 3308-53 | | 2,485.00 |
| Polypropylene | 3308-55 | | 1,866.00 |

| Glove Box Accessories | Cat. # | \$/Each |
|-----------------------------|-----------------|---------------|
| Relief/Bleed Valve* | 1600-60A | 119.00 |
| Flow Meter | 1600-32 | 118.00 |
| RH/Temperature Data Logger | 9500-10 | 205.00 |
| Powder-Coated Stand: Single | 1681-48 | 763.00 |
| Powder-Coated Stand: Twin | 1681-51 | 940.00 |
| Casters (for stands) | 1700-44 | 258.00 |

* Included on ValuLine Portable Glove Boxes



Portable Glove Box

- Fully assembled, ready to use (includes gloves)
- One-piece molded shell makes cleaning a breeze
- Can be configured to allow ducting of fumes

This economical, lightweight glove box is constructed of molded polyethylene, with a large acrylic viewing panel. Interior corners are rounded for easy cleaning, and an 8"-diameter side ports allows sample transfer. Includes neoprene gloves that fit snugly on the 6"-diameter glove ports. Dimensions: 27"W x 13"D x 22"H.

Cat. # **3308-10** \$/Each **1,076.00**

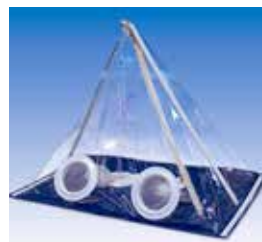

Captair Pyramid Glovebox— for laboratory and field investigations!

- Strong, reliable protection in a mobile and disposable enclosure
- Light simple structure allows for easy assembly
- Laboratory Certified—tested for optimal air-tightness
- Top mounted O-ring piece makes for high mobility and easy storage

The Captair Pyramid is a disposable isolation enclosure that provides excellent protection in a mobile design.

The enclosure, base, and gloves are made of flexible PVC and assembled by high frequency welding to guarantee laboratory certified air tightness. Arm openings are equipped with cuffs on arm sleeves for better rigidity during handlings and support rods maintain the enclosure upright during manipulations.

Cat. # **3015-00** \$/Each **399.00**

No. 3306-62

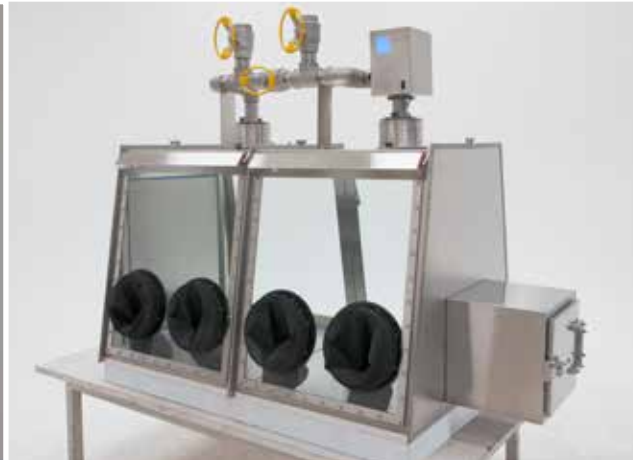

(Above) Stainless steel full-view glove box with tempered glass windows and all-stainless steel piping and valves (No. 1694-90) includes dual chambers with glove ports, fluorescent illuminator, and oversized access door for transferring large process equipment. Shown with optional air lock.

Adjustable filtration design - perfect for weighing and packaging pharmaceutical powders, processing contamination-sensitive samples, and containing fine dust generated during glove box operations (shown with optional pressure gauge and right-side air lock).

FILTRATION GLOVE BOXES

- ULPA filters remove 99.999% of particles 0.12µm or larger
- Brushless EC motor is non-contaminating and energy-efficient
- Three configurations available: Open Loop design exhaust air for safe release; Closed Loop design continuously circulates process gas; Adjustable design lets you select open or closed loop operation

Versatile micro-filtration modules remove powders and other particulates to protect samples and the outside environment—plastic models in stock for immediate shipping!

Plastic and stainless steel construction meets diverse chemical compatibility requirements

ADJUSTABLE AIRFLOW DESIGN

Three valves let you configure open-loop operation, which provides fresh make-up air and filtered exhaust, or closed-loop operation, which continuously circulates the glove box environment through inlet and exit ULPA filters.

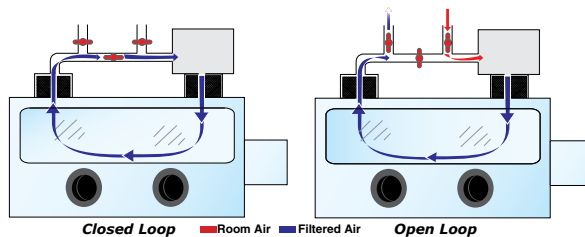

No. 3306-66 (Polypropylene)



No. 3306-60 (Acrylic)



No. 3306-62 (Static-Dissipative PVC)



No. 3306-69 (Polycarbonate)

Adjustable Filtration Glove Boxes

| Material | Single | | Twin | | Air Lock* | |
|------------------------|---------|----------|---------|-----------|-----------|----------|
| | Cat. # | \$/Each | Cat. # | \$/Each | Cat. # | \$/Each |
| Acrylic | 3306-60 | 2,817.00 | 3306-61 | 3,186.00 | 1680-78B | 446.00 |
| Static-Dissipative PVC | 3306-62 | 3,848.00 | 3306-63 | 4,658.00 | 1680-81B | 612.00 |
| Polypropylene | 3306-66 | 3,060.00 | 3306-67 | 3,636.00 | 1680-87B | 495.00 |
| Polycarbonate | 3306-68 | 3,521.00 | 3306-69 | 3,983.00 | 1680-90B | 557.00 |
| Stainless Steel | — | — | 1694-90 | 19,253.00 | 1702-12C | 3,534.00 |

*Standard air lock mounting is on right side of chamber.

OPEN-LOOP CONTAINMENT

This single-pass configuration includes an inlet ULPA filter that removes microcontaminants from air drawn into the glove box. An exit ULPA filter captures fine particles from the exhaust, allowing safe indoor release of exhaust air.

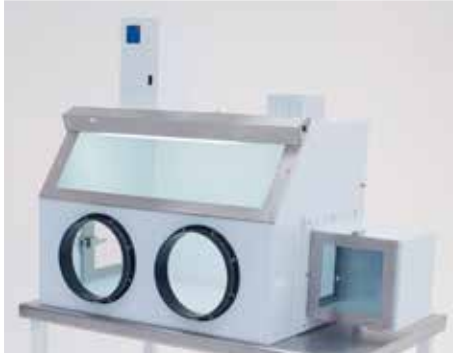
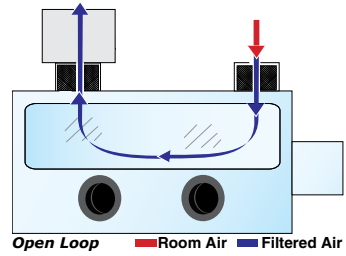

No. 3306-66-OL (Polypropylene)

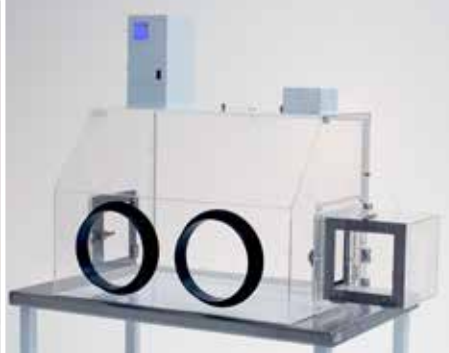

No. 3306-60-OL (Acrylic)

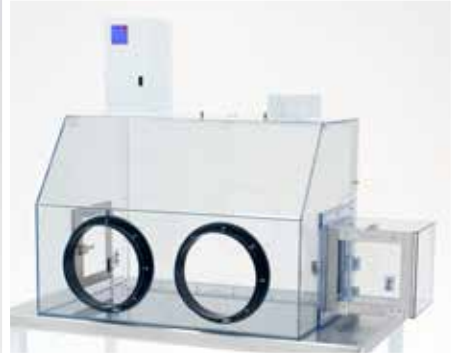

No. 3306-62-OL (Static-Dissipative PVC)

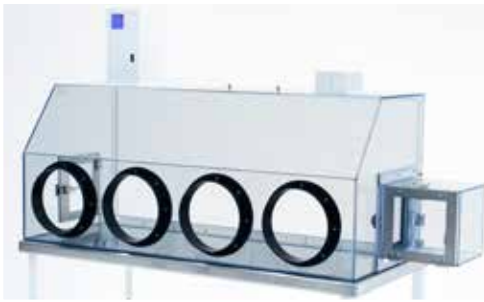

No. 3306-63-OL (SDPVC)

| Open-Loop Filtration Glove Boxes | | | | | | |
|----------------------------------|------------|----------|------------|----------|----------|--------|
| Material | Single | | Twin | | Air Lock | |
| | Cat. # | S/Each | Cat. # | S/Each | Cat. # | S/Each |
| Acrylic | 3306-60-OL | 2,007.00 | 3306-61-OL | 2,268.00 | 1680-78B | 446.00 |
| Static-Dissipative PVC | 3306-62-OL | 2,912.00 | 3306-63-OL | 3,659.00 | 1680-81B | 612.00 |
| Polypropylene | 3306-66-OL | 2,214.00 | 3306-67-OL | 2,547.00 | 1680-87B | 495.00 |

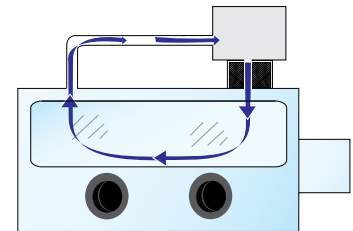

CLOSED-LOOP CONTAINMENT

Closed-loop models continuously recirculate the process gas through an ULPA filter.

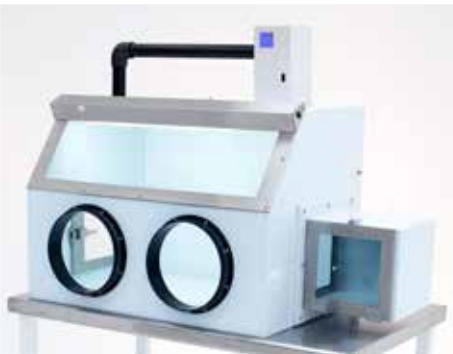

No. 3306-66-CL (Polypropylene)



No. 3306-60-CL (Acrylic)



No. 3306-62-CL (Static-Dissipative PVC)

| Closed-Loop Filtration Glove Boxes | | | | | | |
|------------------------------------|------------|----------|------------|----------|----------|--------|
| Material | Single | | Twin | | Air Lock | |
| | Cat. # | S/Each | Cat. # | S/Each | Cat. # | S/Each |
| Acrylic | 3306-60-CL | 1,917.00 | 3306-61-CL | 2,178.00 | 1680-78B | 446.00 |
| Static-Dissipative PVC | 3306-62-CL | 2,822.00 | 3306-63-CL | 3,569.00 | 1680-81B | 612.00 |
| Polypropylene | 3306-66-CL | 2,124.00 | 3306-67-CL | 2,457.00 | 1680-87B | 495.00 |

| Glove Box Accessories | | Cat. # | S/Each |
|-----------------------------|--|----------|--------|
| Relief/Bleed Valve | | 1600-60A | 119.00 |
| Flow Meter | | 1600-03 | 118.00 |
| RH/Temperature Data Logger | | 9500-10 | 205.00 |
| Powder-Coated Stand: Single | | 1681-48 | 763.00 |
| Powder-Coated Stand: Twin | | 1681-51 | 940.00 |
| Casters (for stands) | | 1700-44 | 258.00 |



No. 3306-67-CL (Polycarbonate)

MINI-ENVIRONMENT EQUIPMENT ENCLOSURE

Interchangeable access ports let you configure the optimal enclosure for your application —

- Solid Panels
- Access Doors
- Glove Ports
- Microscope Bellows
- Iris Ports
- Custom Interface Modules

These Mini-Environment Equipment Enclosures provide a controlled environment for delicate process equipment. Each includes dual front doors for easy access. The bottomless design allows convenient placement over equipment; select the optional spill tray if a bottom is required. Standard size: 49"W x 25"D x 30.25"H (without filter/fan module). Door opening: 22.38"W x 22.25"H (for each door).

Spill Tray

2"H tray safely contains chemical spills and is easy to clean.

| | Cat. # | S/Each |
|-----------------|---------|--------|
| Stainless steel | 2003-35 | 543.00 |
| Polypropylene | 2003-36 | 543.00 |

Ionizing Bar

| | | |
|-------------------|----------|--------|
| 22"L (4 emitters) | 2005-06A | 560.00 |
| 44"L (8 emitters) | 2005-07A | 806.00 |

Microscope Bellows

| | Cat. # | S/Each |
|----------------------------|---------|--------|
| Indicate desired location. | 1681-53 | 246.00 |

Vapor-Sealed

| | | |
|--------------------------------|---------|--------|
| Fluorescent Illuminator | 2400-40 | 401.00 |
|--------------------------------|---------|--------|

Dissipative PVC housing. 120VAC, 60Hz. Other voltages and special lighting available, including germicidal UV.



No. 2003-20 with optional filter module and side doors.



Shown with Iris Ports Cat. # 1694-54, \$340.00/pair. See page 31.



Shown with Glove Ports Cat. # 2003-37, \$302.00/each. See page 30 for gloves.

| Mini-Environment Enclosures | | | Corresponding Side Access Door* | | | |
|-----------------------------|---------|----------|---------------------------------|--------|-----------|--------|
| Material | | | Right Side | | Left Side | |
| | Cat. # | S/Each | Cat. # | S/Each | Cat. # | S/Each |
| Acrylic | 2003-20 | 3,143.00 | 2003-25 | 265.00 | 2003-30 | 265.00 |
| Static-Dissipative PVC | 2003-21 | 3,767.00 | 2003-26 | 293.00 | 2003-31 | 293.00 |
| Polycarbonate | 2003-22 | 3,850.00 | 2003-27 | 306.00 | 2003-32 | 306.00 |

* Front access doors included (as in photos above). Side doors feature stainless steel frame and chrome-plated lift latch. Opening: 15"W x 21"H

Filter/Fan Units

(120VAC, 50/60Hz)

Includes 99.99% efficient HEPA filter. Adds 13" to height. Exit slots provided for air release.

| Cat. # | S/Each |
|-----------|--------|
| 6601-24-H | 777.00 |

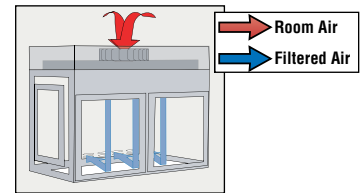

Temperature-controlled models available in sizes up to 120"W — see page 39.

- A. Mini-Environment Equipment Enclosure: Incorporates closed-loop filtration system.
- B. Mini-Environment Equipment Enclosure: Incorporates humidification and dehumidification modules and process gas heater/cooler to maintain stable %RH and temperature levels.
- C. Glovebox with Perforated Bottom: Accommodates recirculation of filtered process gas
- D. Polypropylene Glovebox: includes 0.5"-thick lead base and rear storage shelves
- E. Glovebox with Recirculation System: FilterMate™ removes particles and vapors from recirculated, low-oxygen environment

Call to Discuss Your Unique Requirements!

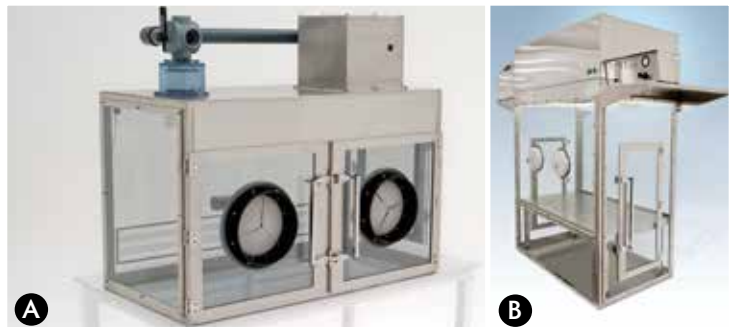



Seconds to install and program!

SMART GLOVEBOX™ AUTOMATED RH CONTROL SYSTEM

Compare!
– to the price of a glovebox with Dual Purge™ / NitroWatch™ control system

- Automates low-humidity processing to prevent degradation of moisture-parts
- Gas control system auto-adjusts nitrogen purge to maintain humidity set point

Terra's Smart Glovebox automatically maintains a low-humidity environment to protect moisture-sensitive parts.

Its quick-response feedback system continuously monitors the chamber's relative humidity level and indicates the measured value on a bright LED display. The minute the %RH climbs above a set point value, the Smart Glovebox activates a flow of dry nitrogen for as long as needed to restore the desired humidity level.

This fast-acting control system economizes on nitrogen use. Comparison testing reveals that the Smart Glovebox maintaining a 10% RH level uses only 22% of the nitrogen required by a flowmeter-based system of identical size. More importantly, this automated operation maintains the integrity of sensitive parts.

The Smart Glovebox includes a control system, Automatic RB valve, and inlet/outlet fittings for 0.25"-diameter gas line. A removable back wall allows introduction of large process equipment. Select air lock, work surface and gloves separately.

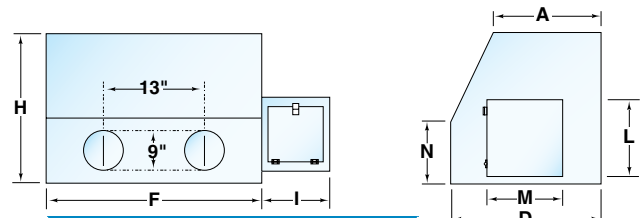

| Nominal Dimensions | | | | | | | |
|--------------------|----|----|----|------|------|----|----|
| A | D | F | H | I | L | M | N |
| 12 | 20 | 26 | 18 | 11.1 | 10.5 | 10 | 11 |



Other Accessories

Stainless Steel Work Surface

Recommended for use in plastic chambers to prevent scratching. Price includes installation (order together with glovebox).

| | Cat. # | S/Each | Cat. # | S/Each |
|--------------------|----------------|---------------|--------------|----------------|
| For Smart Glovebox | 3305-44 | 226.00 | For Air Lock | 3305-45 |
| | | | | 64.00 |

Gloves

Unless indicated, all feature a size 9 hand and are for 8" port.

| | Cat. # | S/Pair |
|---|-----------------|---------------|
| Two-piece Accordion Sleeve/ Nitrile Glove Combination | 1681-91B | 311.00 |
| One-piece Neoprene (black) | 1689-03 | 187.00 |
| Hypalon (white, shown above) | 1671-10 | 234.00 |

Other sizes and materials at TerraUniversal.com

| Smart Glovebox | | | | | | | | | | | | |
|-------------------------|------------------------|-----------------|---------------------------------------|-----------------|------------------------------|-----------------|-----------------|-----------------|------------------------------------|-----------------|---------------------|-----------------|
| See Dimensions Above | Acrylic ⁽¹⁾ | | Static-Dissipative PVC ⁽²⁾ | | Polypropylene ⁽⁴⁾ | | Polycarbonate | | 304 Stainless Steel ⁽³⁾ | | 316 Stainless Steel | |
| | Cat. # | S/Each | Cat. # | S/Each | Cat. # | S/Each | Cat. # | S/Each | Cat. # | S/Each | Cat. # | S/Each |
| Smart Glovebox | 3305-30A | 2,045.00 | 3305-31A | 3,036.00 | 3305-32A | 3,071.00 | 3305-33A | 3,194.00 | 3305-34A | 3,724.00 | 3305-35A | 4,628.00 |
| Air Lock ⁽³⁾ | 3305-38 | 330.00 | 3305-39 | 551.00 | 3305-40 | 447.00 | 3305-41 | 365.00 | 3305-42 | 1,783.00 | 3305-43 | 2,229.00 |

(1) Acrylic is damaged by alcohol and other cleaning agents.

(2) Includes grounding terminals. Stainless steel work surface is required to prevent scratching the dissipative surface.

(3) Standard mounting is on right side (as shown in photo). Includes gas inlet to allow gas purging

(4) Includes 120VAC/60Hz fluorescent light



Series 100 POLYMER GLOVEBOXES

- **Optional gas purge controls automatically**
 - ✓ establish a particle-free environment
 - ✓ maintain a humidity set point down to 0% RH
 - ✓ minimize system recovery time
- **Dual-gasketed side doors and a fully gasketed back permit introduction of small and large equipment**
- **10"-diameter glove ports accept a wide variety of gloves, including Terra's accordion sleeve and glove assembly**

Terra's Series 100 Polymer Gloveboxes provide a clean, low-humidity environment for critical processing operations in such industries as semiconductor and pharmaceutical manufacturing. Their modular design lets you add automated humidity controls to meet critical requirements. Dual side access doors open inward to allow easy parts transfer from inside the chamber. Doors feature stainless steel reinforcement frames that increase the structural rigidity of the door by a factor of five. A built-in LiftLatch™ securely seals the door without applying lateral torque that could damage hinges.

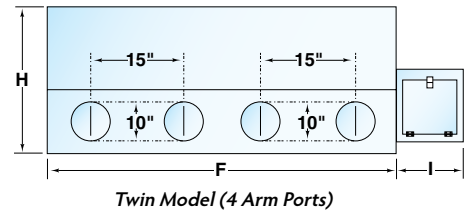
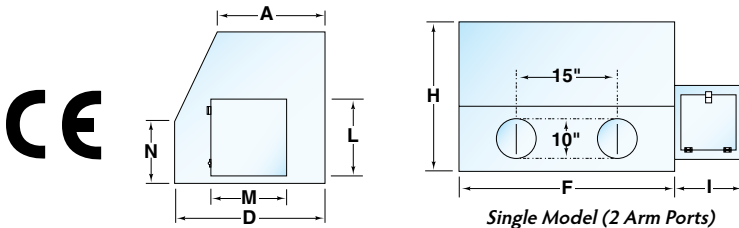

| Nominal Dimensions (inches) | | | | | | | | |
|-----------------------------|-------|----|----|----|------|----|----|----|
| Type | A | D | F | H | I | L | M | N |
| Single | 16.75 | 24 | 35 | 25 | 10.5 | 10 | 10 | 14 |
| Twin | 16.75 | 24 | 59 | 25 | 10.5 | 10 | 10 | 14 |

| Type | Series 100 Plastic Gloveboxes* | | | | | | | | | |
|----------------------------------|--------------------------------|----------|--------------------------|----------|--------------------|----------|--|----------|---------------|----------|
| | Acrylic**** | | Static Dissipative PVC** | | Nondissipative PVC | | Polypropylene*** (Dissipative PVC viewing window) | | Polycarbonate | |
| See Dimensions Above | Cat. # | S/Each | Cat. # | S/Each | Cat. # | S/Each | Cat. # | S/Each | Cat. # | S/Each |
| Single Models (2 glove ports) | 1689-00G-RH | 1,288.00 | 3305-00F-RH | 2,193.00 | 3305-03F-RH | 1,575.00 | 1681-29G-RH | 1,625.00 | 1681-31G-RH | 1,585.00 |
| Twin Models (4 glove ports) | 1689-16G-RH | 1,633.00 | 3305-10F-RH | 2,976.00 | 3305-11F-RH | 2,031.00 | 1681-30G-RH | 1,864.00 | 1681-32G-RH | 1,934.00 |

* Complete with inlet and outlet for gas fittings and relief/bleed valve (order separately).

** Includes grounding terminals. The Stainless Steel Work Surface is recommended with the Static-Dissipative PVC glovebox to prevent scratching.

*** Includes 110VAC, 50/60Hz fluorescent illuminator (for 220VAC/50Hz, add "-220" to the part number).

**** Acrylic is damaged by alcohol and other cleaning agents.

Stainless Steel Work Surface (prevents scratching)

| | Cat. # | S/Each |
|--------|---------|--------|
| Single | 1689-11 | 422.00 |
| Twin | 1681-33 | 591.00 |



Standard Air Lock

These air locks mount on the right side of the glovebox to allow easy pass-through of parts into and out of the chamber. They feature a swing-down door on the front (outside) and a second door that is easy to open by a gloved hand from inside the glovebox. One-piece nonadhesive gasket enhances sealing performance and extends service life. Capped ports are provided to allow purging of the air lock with nitrogen. Right mounting is standard.



Pass-Through Air Lock

Chrome-plated racks accommodate adjustable shelves. In-line double-door construction lets you pass small parts easily into the glovebox; you simply slide a shelf through the outside door to load parts and then through the inside door to unload them in the chamber. Order shelves separately. Right mounting is standard.

| | Cat. # | \$/Each |
|-----------------------|---------|---------|
| Acrylic Shelf | 1680-67 | 21.00 |
| Stainless Steel Shelf | 1680-68 | 80.00 |



Universal Air Lock

The Universal Air Lock features dual flanges (each with gaskets) to permit mounting on either the right or left side of any Terra plastic glovebox. They also allow multiple gloveboxes to be connected in series. Select material compatible with your glovebox(es). Right mounting is standard.

Stainless steel frames now standard on all access doors.

| Type | Series 100 Air Locks ** (each includes ports for nitrogen purging/bleeding) | | | | | | | | | | | |
|-----------------------|---|---------|------------------------|---------|--------------------|---------|--|---------|---------------|---------|--|---------|
| See Dimensions Above | Acrylic* | | Static Dissipative PVC | | Nondissipative PVC | | Polypropylene (Dissipative PVC viewing window) | | Polycarbonate | | Stainless Steel Work Surface (prevents scratching) | |
| | Cat. # | \$/Each | Cat. # | \$/Each | Cat. # | \$/Each | Cat. # | \$/Each | Cat. # | \$/Each | Cat. # | \$/Each |
| Standard Air Lock | 1680-78B | 446.00 | 1680-81B | 612.00 | 1680-84B | 495.00 | 1680-87B | 495.00 | 1680-90B | 557.00 | 1680-69 | 212.00 |
| Pass-Through Air Lock | 1680-79B | 485.00 | 1680-82B | 710.00 | 1680-85B | 533.00 | 1680-88B | 602.00 | 1680-91B | 515.00 | 1680-69 | 212.00 |
| Universal Air Lock | 1680-80B | 491.00 | 1680-83B | 720.00 | 1680-86B | 541.00 | 1680-89B | 610.00 | 1680-92B | 524.00 | 1680-69 | 212.00 |

* Acrylic is damaged by alcohol and other cleaning agents. ** All are right mount chambers. Left mount chambers available.



Changeable Sleeve and Glove Combination (for 10"-diameter ports)

Can be used with a variety of gloves, allowing you to change glove size or type without changing the sleeve itself. The convoluted section keeps the sleeve off the operator's arm for better air circulation and comfort. Supplied with one pair of nitrile gloves (select desired size). Clamps included.

See page 30 for additional gloves.

| Glove Size | With 18" Sleeve | Cat. # | \$/Pair |
|------------|-----------------|---------|---------|
| 8 | | 1689-46 | 359.00 |
| 9 | | 1689-47 | 343.00 |
| 10 | | 1689-48 | 344.00 |



IonBar™ (with fan module)

Projects a balanced stream of ions for neutralization of static charges throughout a restricted area. Price includes installation inside specified glovebox. Models below are for 120VAC operation.

| Cat. # | \$/Each | |
|----------|---------|----------|
| 22" Long | 2005-30 | 900.00 |
| 33" Long | 2005-32 | 1,016.00 |
| 44" Long | 2005-31 | 1,133.00 |

Fans ensure even ion distribution.

Stands for Series 100 Gloveboxes

Constructed of all-welded 2" square tubing.

| | For Single Models (35"W x 24"D x 30"H) | | For Twin Models (59"W x 24"D x 30"H) | |
|--|--|----------|--------------------------------------|----------|
| | Cat. # | \$/Each | Cat. # | \$/Each |
| Powder-Coated Steel Stand | 1681-48 | 763.00 | 1681-51 | 940.00 |
| Stainless Steel Stand | 1681-49 | 1,055.00 | 1681-52 | 1,410.00 |
| Casters (set of 4, 2 with brakes) | | | 1700-44 | 258.00 |

Fixed Rear Wall

A fixed rear wall can be specified in place of the standard removable rear wall.

| Cat. # | \$/Each |
|---------|---------|
| 1681-58 | 134.00 |

Detachable Bottom

Allows Series 100 glovebox to be lifted for easy placement over large equipment.

| Cat. # | \$/Each |
|---------|---------|
| 1681-55 | 395.00 |



Plastic Glove Port (see pg. 31 for other designs)

Standard on all Terra gloveboxes; can be retrofitted on chamber with 11.25" dia. cutouts. Price for single port.

| Cat. # | \$/Each |
|---------|---------|
| 1694-52 | 225.00 |

Glove Port

Port Caps 1694-53 218.00

Iris Adapter (see pg 31) 1694-54 340.00

Corresponding Options

| Ionizing Bar (see above) | | Fluorescent* Illuminator | | Power Strip ⁵ 110VAC/60Hz | | Dual Purge System (see page 32) | | NitroWatch™ (see page 32) | | Automatic RB® Valve (see page 32) | | |
|--------------------------|----------|--------------------------|---------|--------------------------------------|---------|---------------------------------|----------|---------------------------|----------|-----------------------------------|----------|--------|
| Cat. # | \$/Each | Cat. # | \$/Each | Cat. # | \$/Each | Cat. # | \$/Each | Cat. # | \$/Each | Cat. # | \$/Each | |
| 2005-32 | 1,016.00 | 1681-78 | 458.00 | 1681-80 | 167.00 | 1603-57 | 2,994.00 | Control: | 9500-00A | 1,002.00 | 1600-60B | 104.00 |
| 2005-31 | 1,133.00 | 1681-79 | 618.00 | 1681-80 | 167.00 | 1603-57 | 2,994.00 | Sensor: | 9500-02A | 596.00 | 1600-60B | 104.00 |

⁴ Comes standard on polypropylene models. Models above are 110VAC/60Hz. Add "-220" to the catalog number for 220VAC/50Hz power.

⁵ Mounted horizontally on the inside rear wall, 3" from the bottom (specify other position, if desired). Includes master on/off switch, 15-Amp circuit breaker and 4 outlets.

See facing page for negative pressure configurations

Stainless steel door frames with unique "e" profile elastomer gasket increase structural rigidity, extend service life, improve sealing performance



Series 200 NEGATIVE-PRESSURE GLOVEBOXES

- Ideal for drying, degassing, and ventilation applications
- Clear construction (of acrylic or polycarbonate) provides full visibility of work in progress
- Sturdy construction allows sustained negative pressure operation at 5" WG (29.9" Hg in vacuum antechamber)
- Vacuum safety valve included to prevent damage to walls or seals

These economical vacuum gloveboxes are designed for degassing operations, chemical mixing, biological tests, and other processes requiring sustained negative pressure. Each chamber is fabricated out of solvent-welded 1/2" transparent material that combines full visibility with light weight, cleanliness and durability. Dual glove ports allow full access to work in progress. Select acrylic for general applications, or polycarbonate for resistance to a wide range of chemicals and thermal stress. Equipped with a vacuum safety valve on a standard basis, these chambers are designed for operations with sustained negative pressures down to 5" WG (Water Gauge). Dual side access doors open inward to allow easy parts transfer from inside the chamber.



No. 1681-15D with No. 1680-93B air lock

Optional negative-pressure air lock

Optional Swing-Up Front Access Panel

Other Options:

See gloves on page 30.

Stainless Steel Work Surface

Protects the bottom of the chamber against scratching. Price includes installation.

| | Cat. # | S/Each |
|---------------|---------|--------|
| For Air Lock | 1680-69 | 212.00 |
| For Glove Box | 1689-11 | 422.00 |

Glove Port Covers

"O"-ring ensures a tight seal. Includes handle for easy removal.

| | Cat. # | S/Each |
|-------------------|---------|--------|
| Port Cover | 1694-53 | 218.00 |
| Iris Port Adapter | 1694-54 | 340.00 |

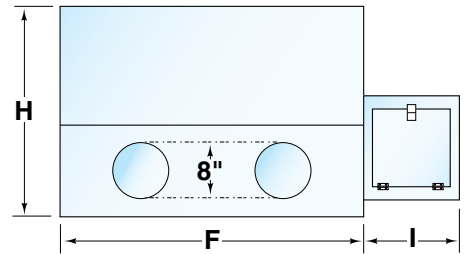
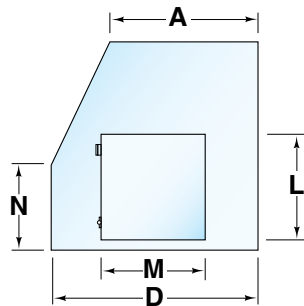

Nominal Dimensions (inches).

| Glove Ports | A | D | F | H | I | L | M | N |
|-------------|-------|----|----|----|------|----|----|----|
| 2 | 16.25 | 24 | 35 | 25 | 11.5 | 10 | 10 | 14 |

Series 200 Negative-Pressure Gloveboxes

| With Front Access Panel* | | | | Without Front Access Panel | | | | Corresponding Accessories | | | | | |
|--------------------------|----------|---------------|----------|----------------------------|----------|---------------|----------|---|----------|--------------------------------|----------|----------|--------|
| Acrylic** | | Polycarbonate | | Acrylic** | | Polycarbonate | | Vacuum Antechamber (12" Diameter, see photo below) | | Negative Pressure Air Lock *** | | | |
| | | | | | | | | 12"L | | 23"L | | | |
| Cat. # | S/Each | Cat. # | S/Each | Cat. # | S/Each | Cat. # | S/Each | Cat. # | S/Each | Cat. # | S/Each | | |
| 1681-13D | 2,781.00 | 1681-14D | 5,171.00 | 1681-15D | 2,375.00 | 1681-16D | 4,401.00 | 1681-63 | 3,052.00 | 1681-67 | 3,696.00 | 1680-93B | 815.00 |

* Cutout Size: 20"W x 10"H

** Acrylic is damaged by alcohol and other cleaning agents.

*** Right mount acrylic airlock. Other styles at TerraUniversal.com

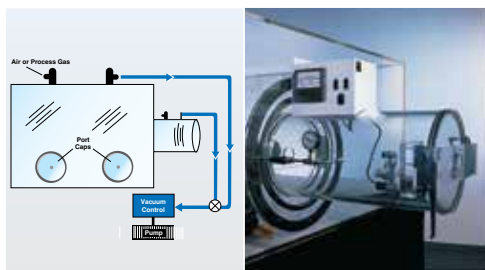

Vacuum Antechamber (ordering information above)

Allows drying or degassing at up to one full atmosphere (29.9" Hg).

Vacuum Control Module

| | | |
|-----------------|--------------------|-----------------|
| 110VAC, 50/60Hz | Cat. # 1681-75 | S/Each 2,878.00 |
| 220VAC, 50Hz | Cat. # 1681-75-220 | S/Each 2,878.00 |

Vacuum Pump

| | | |
|-----------------|--------------------|-----------------|
| 110VAC, 50/60Hz | Cat. # 7901-00 | S/Each 2,895.00 |
| 220VAC, 50Hz | Cat. # 7901-08-220 | S/Each 2,937.00 |

Series 210 VACUUM GLOVEBOXES

- 1.5"-thick reinforced acrylic walls support full vacuum (to 29.9" Hg)
- Dual hose barb fittings simplify connection to vacuum pump to allow rapid air removal and backfill with clean, dry process gas
- Perfect for anaerobic processing in a low-humidity nitrogen or argon environment
- Select Trace Oxygen Analyzer to maintain oxygen levels to 1 ppm

The Series 210 Glovebox supports a wide range of vacuum and degassing operations.

This vacuum capability also allows removal of atmospheric humidity and oxygen and backfill with a process gas, quickly providing a moisture-free, low-oxygen environment.

For automated vacuum control, select the Vacuum Control Module, pump and connection kit below. For automated backfill and purging, select the Dual Purge™ System and Trace Oxygen Analyzer, which work in tandem to provide oxygen levels down to 10 ppm(v).

The optional air lock allows transfer of materials into the glovebox without breaching the controlled environment.

Series 210 Vacuum Glovebox

Includes leveling feet, dual valves for connection to vacuum pump and backfill gas source, pressure gauge and relief/bleed valve, which closes during vacuum operations. Order airlock gloves and vacuum/purge controls separately.

| | | |
|------------|----------|-----------|
| Max Vacuum | Cat. # | S/Each |
| 29.9" Hg | 3305-46A | 10,244.00 |

Series 210 Vacuum Air Lock

| | | |
|------------|-------------|----------|
| Left Mount | Right Mount | |
| Cat. # | Cat. # | S/Each |
| 3305-48 | 3305-49 | 2,078.00 |

Designed to support 29.9" Hg vacuum, it includes dual vacuum/gas valves and vacuum gauge.

Purge Connection Kit

Required for applications requiring continuous nitrogen purge following vacuum cycling. Includes bleed valve and ports for Oxygen Analyzer and Dual Purge System, with isolation shut-off valves.

| | |
|---------|--------|
| Cat. # | S/Each |
| 3305-50 | 305.00 |

No. 3305-46A with airlock and accordion sleeve/glove combination



Front doors close to seal chamber during vacuum cycles

How to Attain Extremely Low RH/O₂ Concentrations:

Vacuum Cycling vs. Purge and Bleed

Vacuum cycling provides a fast, economical way to achieve extremely low moisture and oxygen levels inside a glovebox.

Purge-and-bleed displacement relies on a continuous purge of dry process gas (typically, nitrogen or argon) to displace moisture-laden air, which exits through a bleed valve. This process typically requires many hours, consumes a high volume of process gas, and may never achieve very low oxygen concentrations (below 5 ppm) required in many applications.

Vacuum cycling evacuates ambient air—and with it, moisture and oxygen—inside a vacuum chamber or glovebox. When air is removed, you simply backfill the chamber with process gas until the chamber attains neutral pressure. If needed, this process is repeated until oxygen or moisture concentration reaches the desired level. Typically, only a few cycles, requiring only a fraction of the gas and time of a purge-and-bleed protocol, are all that's needed to reach single-digit oxygen concentrations.

Once set point levels are attained, close off vacuum valves and use a Dual Purge System and appropriate controller (NitroWatch™ for relative humidity, Trace Oxygen Analyzer for O₂ concentration) to maintain dry, anaerobic conditions.

See Bactron chambers on page 35 for an alternative anaerobic environment.

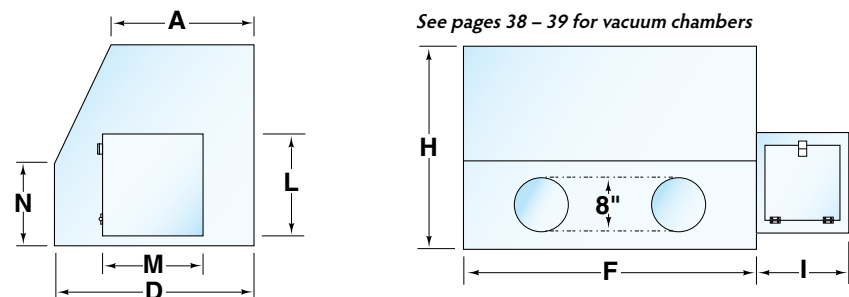

See pages 32 - 33

Nominal Dimensions (inches).

| Nominal Dimensions (OD includes external support ribs) | Nominal Dimensions (inches) | | | | | | | |
|--|-----------------------------|-------|-------|-------|-------|-------|------|-------|
| | A | D | F | H | I | L | M | N |
| OD | 16 | 29 | 32 | 29.5 | 12.75 | 12 | 11 | 17.33 |
| ID | 14.69 | 22.13 | 30.25 | 22.75 | 10.83 | 10.13 | 9.13 | 13.63 |

Glove Ports

Special designs and materials, including oval stainless steel ports and bag-out ports.

See page 31.





No. 3305-54B, shown with optional metering valves and vacuum gauge

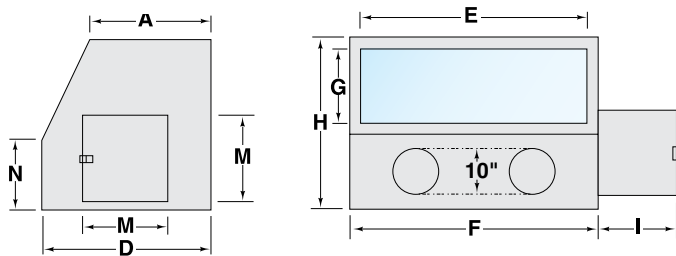

Nominal Dimensions

| A | D | F | H | I | L | M | N | N |
|-------|----|-------|----|-------|----|----|-------|----|
| 16.56 | 24 | 28.25 | 35 | 11.75 | 28 | 28 | 14.75 | 14 |

Series 310 Negative Pressure Stainless Steel Glovebox (Tempered Safety Glass Window)

| Material | With Right-Side Air Lock | | With Left-Side Air Lock | | With Dual-Side Air Locks | |
|----------|--------------------------|-----------|-------------------------|-----------|--------------------------|-----------|
| | Cat. # | S/Each | Cat. # | S/Each | Cat. # | S/Each |
| 304 SS | 3305-54B | 17,740.00 | 3305-55B | 17,740.00 | 3305-56B | 22,130.00 |
| 316 SS | 3305-60B | 21,569.00 | 3305-61B | 21,569.00 | 3305-62B | 26,444.00 |

| | | | | | | | | | |
|--|--------|---------|--------|--------|--|--------|---------|--------|----------|
| Stand (powder-coated steel) | Cat. # | 3305-66 | S/Each | 591.00 | Vacuum Valves (order two/chamber) | Cat. # | 5235-09 | S/Each | 168.00 |
| Port Cover | | 1694-53 | | 218.00 | Vacuum Gauge (order one/chamber) | | 5235-10 | | 206.00 |
| Accordion Sleeve/Glove Combo (pair) | | 1689-47 | | 343.00 | Glovebox Vacuum Control Module | | 3305-67 | | Call TUI |

Automates vacuum application to allow vacuum/purge cycling, allowing rapid moisture and oxygen removal.

For 220V models, add "-220" to the part number. Order gloves, port covers, and vacuum/purge controllers separately (full specifications at TerraUniversal.com)

Series 310

STAINLESS STEEL NEGATIVE PRESSURE GLOVEBOX

- Designed for rapid removal of oxygen and backfill with nitrogen or argon to establish anaerobic processing environment (see sidebar on page 15)
- Continuous-seam welds with radius corners simplify cleaning and reduce leak rate during vacuum cycling
- Optional vacuum controls accelerate oxygen removal and backfill with inert process gas
- Select Trace Oxygen Analyzer and Dual Purge™ System to maintain oxygen levels to 1 ppm (see pages 32 and 33)

The Series 310 Stainless Steel Glovebox features reinforced 12-gauge stainless steel construction with continuous-seal welds to support vacuum pressure/inert gas backfill cycling that quickly removes atmospheric oxygen and moisture. A tempered safety glass window and fluorescent light provides visibility of the work area.

For automated vacuum control, select the Vacuum Control Module, pump and connection kit below. For automated backfill and purging, select the Dual Purge System and Trace Oxygen Analyzer, which work in tandem to provide oxygen levels down to 10 ppm(v). Right or left-side air locks allow transfer of materials into the glovebox without breaching the controlled environment.

GLOVEBOX IONIZING MODULES

- Provides safe, effective static neutralization inside a glovebox or other process chamber
- Generates a balanced stream of positive and negative ions to neutralize surface charges, eliminating the risk of electro-static discharge
- Low-voltage design is safe, minimizes EMI/RFI
- Fans ensure uniform ion distribution throughout the chamber

These ionizing modules incorporate highly reliable emitters that operate on 24V input voltage, enhancing product safety. Discharge times directly under the unit average 28 seconds (from ± 1,000 volts to 100 volts, measured in accordance with Ionization Standard ANSI ESO/ESD S3.1-1991 of the ESD Association).



Glovebox Ionizing Modules (price includes installation)

| Bar Length | 110VAC | | 220VAC | |
|------------------|---------|----------|-------------|----------|
| | Cat. # | S/Each | Cat. # | S/Each |
| 11" (2 emitters) | 2005-29 | 790.00 | 2005-29-220 | 790.00 |
| 22" (4 emitters) | 2005-30 | 900.00 | 2005-30-220 | 900.00 |
| 33" (6 emitters) | 2005-32 | 1,016.00 | 2005-32-220 | 1,016.00 |
| 44" (8 emitters) | 2005-31 | 1,133.00 | 2005-31-220 | 1,133.00 |

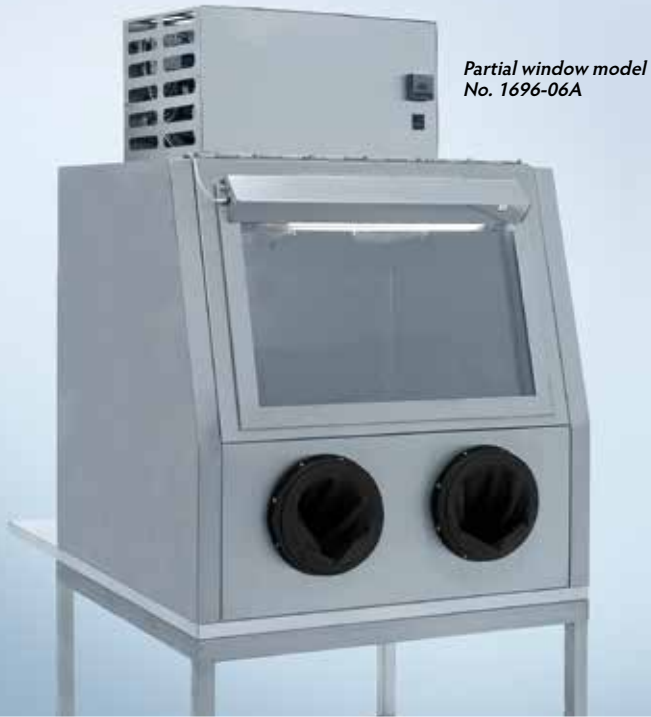

INSULATED GLOVEBOXES

- 2" of polyurethane insulation ensure stable, efficient temperature control over a wide operating range (-25°F to +140°F/-32°C to +60°C)
- Provide stable operating temperatures in critical applications
- 304 stainless steel chamber provides a noncontaminating, durable, chemical-resistant enclosure
- Double-glazed polycarbonate viewing windows provide visibility of work in progress (select partial or full-view design)
- Includes fluorescent illuminator
- Terra's Constant Temperature Control System provides stable temperature (order separately)

These double-wall, insulated chambers boost thermal efficiency to create stable process temperatures and decrease the cost of heating and cooling cycles.

Both include two 10"-diameter ports, providing ample space for arm motion inside gloves (order gloves separately). Select Full-View or Partial-View front panels. Both models include double-glazed polycarbonate windows.

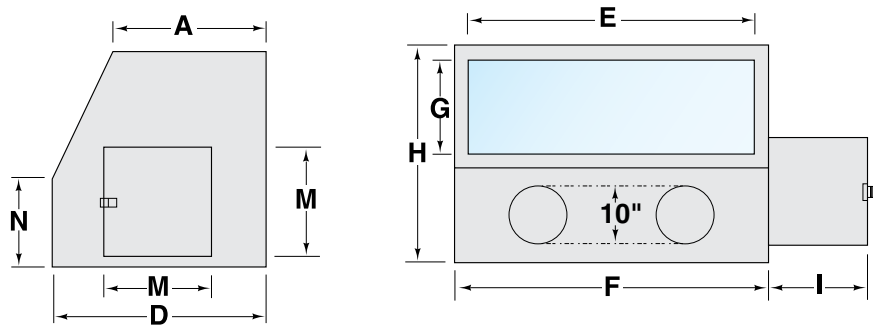

| Outside Dimensions (subtract 4" for I.D.) | | | | | | | | | |
|---|----|----|-------|----|-------|----|----|----|----|
| Front Panel | A | D | E | F | G | H | I | M | N |
| Full Window | 28 | 33 | 37 | 41 | 35 | 43 | 14 | 12 | — |
| Partial Window | 31 | 37 | 28.25 | 37 | 12.81 | 39 | 14 | 12 | 14 |

Special sizing and configurations available — call to discuss your requirements.

Constant Temperature Control System

| Temperature Range | Compressor Size | BTU/Hour Capacity | 110VAC, 50/60Hz | | 220VAC, 50/60Hz | |
|-------------------|-----------------|-------------------|-----------------|-----------|-----------------|-----------|
| | | | Cat. # | \$/Each | Cat. # | \$/Each |
| -10° to 120°F | 0.5HP | 3800 | 1694-76 | 16,670.00 | 1694-76-220 | 16,670.00 |
| -25° to 120°F | 0.75HP | 5900 | 1694-78 | 20,143.00 | 1694-78-220 | 20,143.00 |
| 5° to 120°F | 0.5HP | 3800 | 1694-75 | 15,513.00 | 1694-75-220 | 15,513.00 |
| 5° to 120°F | 0.75HP | 5900 | 1694-77 | 18,985.00 | 1694-77-220 | 18,985.00 |

| Insulated Gloveboxes | | | | Air Lock* | | | | Stands | | Tilt-up Door | | |
|----------------------|----------|-----------|--------------|-----------|------------|----------|-----------|---------|---------|--------------|-----------|--|
| Window | 120VAC | | 220VAC | | Right Side | | Left Side | | | | | |
| | Cat. # | \$/Each | Cat. # | \$/Each | Cat. # | Cat. # | \$/Each | Cat. # | \$/Each | Cat. # | \$/Each | |
| Full Window | 1696-05A | 15,693.00 | 1696-05A-220 | 15,693.00 | 1696-07A | 1696-08A | 3,146.00 | 1696-11 | 651.00 | 1684-92 | 2,067.00 | |
| Partial Window | 1696-06A | 16,087.00 | 1696-06A-220 | 16,087.00 | 1696-09A | 1696-10A | 3,146.00 | 1696-12 | 627.00 | 1684-93 | 2,376.00! | |

* Air locks feature double-wall constructions but no insulation. Inside dimensions: 12" x 12" x 12"
Order desired gloves and temperature control module separately.

Series 300 STAINLESS STEEL GLOVEBOXES

- Provides a clean, controlled environment for manufacturing processes in semiconductor, pharmaceutical, and other industries
- Transparent dissipative PVC window affords full view of processing area
- Side flanges simplify insertion/removal of process equipment and allow easy addition of ovens and air locks
- 10"-diameter ports accept a wide variety of gloves and accommodate port covers and iris adapters
- Select single model (with two glove ports) or twin model (with four glove ports)

The Series 300 Stainless Steel Controlled Atmosphere Chamber provides a hermetically sealed environment for such manufacturing operations as resistance welding of semiconductor hybrids, parts degassing, temperature and humidity testing, and chemical mixing in a nonreactive environment.



Elastomer seal for superior performance

Air Lock Provides Convenient Access. Shown with optional viewing window. See page 28.



DewWatch™ Humidity Controller (see page 32)

Glovebox Dual Purge™ System (see page 32)

Air Lock

4-Port Twin Chamber (No. 1694-02)

Pass-Through Oven (No. 5401-00A; see page 29)

Vacuum/Nitrogen Pump

Cleanroom Chair No 1012-41 \$477.00

Series 300 STAINLESS STEEL GLOVEBOX SPECIFICATIONS & ORDERING INFORMATION

Door Openings: 12 1/2" x 12 1/2" with gasketed doors supplied with air locks (see ordering information below); doors open inward.

Arm Ports: 10" round with flange for connecting glove assembly. See page 31

Gas Ports: Fittings for 1/4" gas inlet and system pressure lines; port for Automatic RB® Valve. Appropriate adapter inserts are supplied for any Terra gas systems ordered.

Light: Fluorescent. (select voltage below)

Window: Static-dissipative PVC

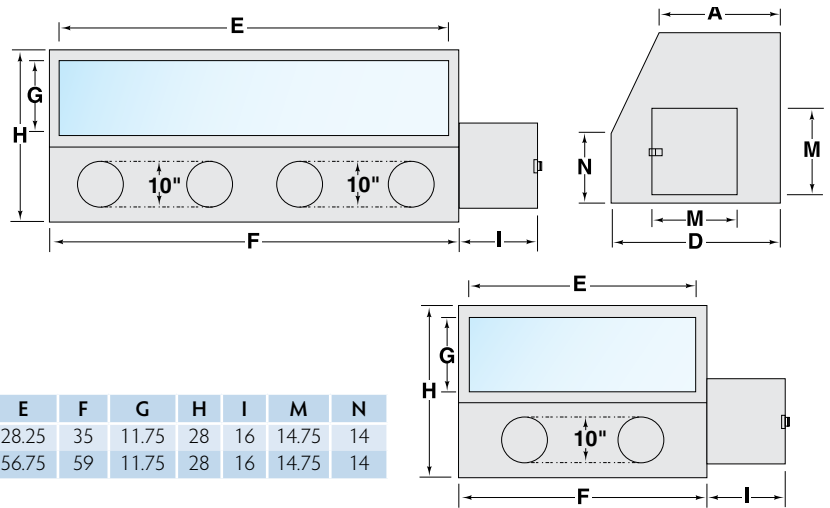

All dimensions in inches

| Model | Glove Ports | A | D | E | F | G | H | I | M | N |
|--------|-------------|---------|----|-------|----|-------|----|----|-------|----|
| Single | 2 | 16.5625 | 24 | 28.25 | 35 | 11.75 | 28 | 16 | 14.75 | 14 |
| Twin | 4 | 16.5625 | 24 | 56.75 | 59 | 11.75 | 28 | 16 | 14.75 | 14 |

| Series 300 Gloveboxes* | | Corresponding Air Locks** | | | | | | | |
|------------------------|-------------|---------------------------|-----------|--------------|-----------|------------|--------|-----------|----------|
| Model | Glove Ports | 120VAC | | 220VAC | | Right Side | | Left Side | |
| | | Cat. # | S/Each | Cat. # | S/Each | Cat. # | S/Each | Cat. # | S/Each |
| Single | 2 | 1694-01C | 6,543.00 | 1694-01C-220 | 6,543.00 | 1702-10C | | 1702-11C | 3,534.00 |
| Twin | 4 | 1694-02C | 10,066.00 | 1694-02C-220 | 10,066.00 | 1702-10C | | 1702-11C | 3,534.00 |

BUY ONLINE! Items priced in blue usually ship in 1-3 days.

* 304 stainless steel with static-dissipative PVC viewing window
 ** Multiple air lock sizes available; see page 28



No. 1690-03

Stands for Series 300 Gloveboxes

Constructed of all-welded 2" square tubing. Select oven support for use with Terra's High-Performance Pass-Through Oven (No. 5401-00, see page 25). All stands raise chambers 28.75" off of floor (add 3" for casters).

| Powder-Coated Steel | | | | 304 Stainless Steel | | | |
|---------------------|--------|------------------|----------|---------------------|----------|------------------|----------|
| Chamber Only | | Chamber and Oven | | Chamber Only | | Chamber and Oven | |
| Cat. # | S/Each | Cat. # | S/Each | Cat. # | S/Each | Cat. # | S/Each |
| 1690-03 | 602.00 | 5401-01 | 906.00 | 1694-09 | 1,178.00 | 1694-11 | 1,780.00 |
| 1690-04 | 731.00 | 5401-02 | 1,035.00 | 1694-10 | 1,442.00 | 1694-12 | 2,051.00 |

For Single Models (2 ports)
 For Twin Models (4 ports)

Heavy-Duty Casters (set of 4, 2 with brakes) Cat. # 1700-44 S/Each 258.00

Other Optional Accessories

| | Cat. # | S/Each | Page |
|-------------------------------------|-------------|----------|------|
| Glovebox Dual Purge™ System | 1603-57 | 2,994.00 | 32 |
| NitroWatch™ | 9500-00A | 1,002.00 | 32 |
| NitroWatch Sensor | 9500-02A | 596.00 | 32 |
| Stainless Steel Automatic RB® Valve | 1606-60 | 198.00 | 32 |
| Accordion Sleeve/Glove Combination | 1689-47 | 343.00 | 30 |
| Right-Side Access Door | 1685-94-300 | 994.00 | |
| Left-Side Access Door | 1685-96-300 | 994.00 | |

High-Performance Vacuum Oven
 See pg. 29 for specifications and ordering information.

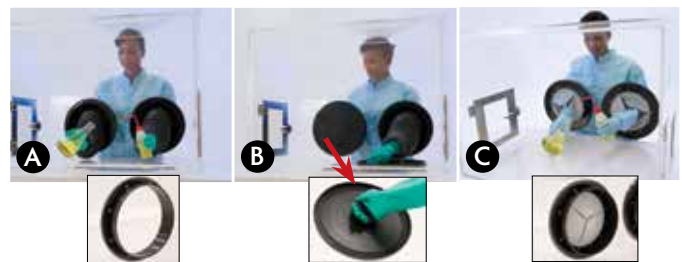

Oval and stainless steel ports—see page 31.

Plastic Glove Port, Cover, and Iris Adapter

10"-diameter port is standard on all Terra gloveboxes. Order covers and iris adapter separately (see page 31).

| | Cat. # | S/Each |
|---------------------------|---------|--------|
| A. Replacement Glove Port | 1694-52 | 225.00 |
| B. Glove Port Cover | 1694-53 | 218.00 |
| C. Iris Adapter | 1694-54 | 340.00 |



IonBar™ (with fan module)

Projects a balanced stream of positive ions for neutralization of static charges throughout a restricted area. Price includes installation inside specified glovebox. Models below are for 120VAC operation.

| | Cat. # | S/Each |
|----------|---------|----------|
| 22" Long | 2005-30 | 900.00 |
| 33" Long | 2005-32 | 1,016.00 |
| 44" Long | 2005-31 | 1,133.00 |

Fans ensure even ion distribution.

Series 400 STAINLESS STEEL GLOVEBOX

- Roomy 304 stainless steel chamber provides ample space for large processing equipment
- Interfaces with Vacuum Antechamber for vacuum operations down to 29.9" Hg
- Optional gas purge controls automatically maintain a humidity set point down to 0% RH/0.5 ppm(v) H₂O

These chambers are a larger version of the Series 300 chambers listed on the preceding pages.

In addition to all of the features of the Series 300 models, these chambers also accommodate Terra's Vacuum Antechamber, which supports vacuums down to 29.9" Hg for a wide range of operations in many industries. Their double-gasketed side flange allows easy insertion of large process equipment into the work chamber and easy mounting of the antechamber, a vacuum/nitrogen oven, or a standard air lock.

Specifications: Series 400 Glovebox

Door Openings: 12" x 12" gasketed doors supplied with air locks (see ordering information on facing page); doors open inward.

Arm Ports: 10" round with flange for connecting glove assembly

Windows: Static-dissipative PVC

Specifications: Vacuum Antechamber

Construction: 6061 Aluminum (with brass fittings); or stainless steel (with stainless steel fittings); high-vacuum design; TIG welded structure

Dimensions: 15" dia. x 24" long

Tray Dimensions: 12" x 23"; extends to 14" beyond opening for loading

Doors: Single center-clamped, O-ring sealed, counterbalanced, vertical travel; stainless steel on both models

Vacuum Capability: 1 x 10⁻³ Torr

Vacuum Gauge: 2 1/2" compound Bourdon tube dial type

Connections: 1" evacuation valve, 1/4" backfill valve, 1/4" IPS plug

Series 400 Chambers (304 Stainless Steel)

| Model | Glove Ports | Cat. # | \$/Each |
|--------|-------------|----------|-----------|
| Single | 2 | 1694-13B | 10,651.00 |
| Twin | 4 | 1694-14B | 16,437.00 |



Modular Vacuum/Nitrogen Oven
(see facing page)

Order Air Locks from
table on the next page

Dual Purge™ System

Air Lock

Model shown: Single Chamber (Cat. No. 1694-13) with Dual Purge System, and Air Lock

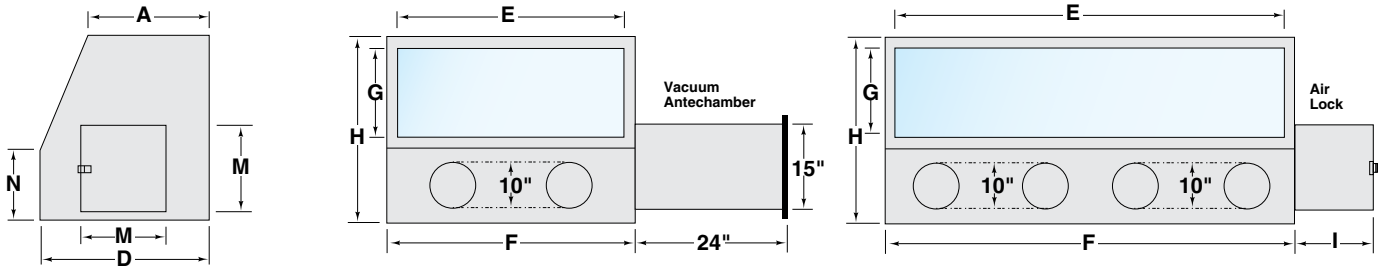

| Glove Ports | A | D | E | F | G | H | I | M | N |
|-------------|----|----|-------|----|---------|----|----|----|----|
| 2 | 27 | 33 | 28.25 | 33 | 12.9325 | 33 | 16 | 12 | 14 |
| 4 | 27 | 33 | 56.5 | 60 | 12.9325 | 33 | 16 | 12 | 14 |

All models include a 120VAC/60Hz fluorescent illuminator. For 220VAC/50Hz power, add "-220" to the catalog number. For electropolishing of any stainless steel component, add "-2" to the catalog number and 30% to the price. All dimensions in inches.

| Air Lock** | | | Vacuum/Nitrogen Ovens (left side mounting standard) | | | | | |
|-------------|------------|----------|---|------------|-----------|---------------------------|------------|----------|
| | | | High Performance Pass-Through Oven* (see pg. 29) | | | Modular Oven (see pg. 29) | | |
| Right Mount | Left Mount | | Right Mount | Left Mount | | Right Mount | Left Mount | |
| Cat. # | Cat. # | \$/Each | Cat. # | Cat. # | \$/Each | Cat. # | Cat. # | \$/Each |
| 1698-01C | 1698-02C | 3,350.00 | 5401-12A | 5401-00A | 18,131.00 | 9602-30A | 9602-03A | 6,134.00 |

* Requires support stand for safe operation (order below). For 220VAC operation, add "-220" to the part number.

** Prices for left-mount and right-mount models are the same. Optional 7"W x 9.5"H safety glass viewing window—Cat. # 1702-02

Stands for Series 400 Gloveboxes

Constructed of all-welded 2" square tubing, these stands are specially designed to support Series 400 gloveboxes. Select powder-coated (white) steel or stainless steel stands, with or without rubber casters.

| Heavy-Duty Casters (set of 4, 2 with brakes) | Cat. # | \$/Each |
|--|---------|---------|
| | 1700-44 | 258.00 |

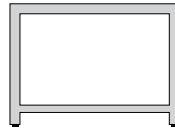

For chamber only

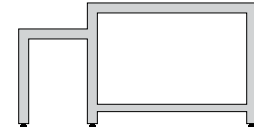

For chamber and oven No. 5401-00

| | 304 Stainless Steel | | Powder Coated Steel | | 304 Stainless Steel | | Powder Coated Steel | |
|-----------------------------|---------------------|----------|---------------------|---------|---------------------|----------|---------------------|---------|
| | Cat. # | \$/Each | Cat. # | \$/Each | Cat. # | \$/Each | Cat. # | \$/Each |
| For Single Models (2 ports) | 1694-15 | 1,327.00 | 1694-17 | 602.00 | 1694-19 | 1,940.00 | 1694-21 | 902.00 |
| For Twin Models (4 ports) | 1694-16 | 1,410.00 | 1694-18 | 674.00 | 1694-20 | 2,064.00 | 1694-22 | 956.00 |



IonBar™ (with fan module)
Projects a balanced stream of positive ions for neutralization of static charges throughout a restricted area. Price includes installation inside specified glovebox. Models below are for 120VAC operation.

Fans ensure even ion distribution.

| | Cat. # | \$/Each |
|----------|---------|----------|
| 22" Long | 2005-30 | 900.00 |
| 33" Long | 2005-32 | 1,016.00 |
| 44" Long | 2005-31 | 1,133.00 |

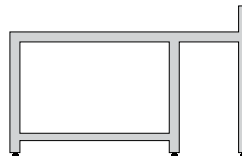

For chamber and vacuum antechamber

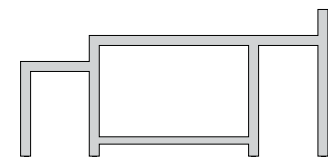

For chamber, vacuum antechamber, and oven No. 5401-00

| | 304 Stainless Steel | | Powder Coated Steel | | 304 Stainless Steel | | Powder Coated Steel | |
|-----------------------------|---------------------|----------|---------------------|----------|---------------------|----------|---------------------|----------|
| | Cat. # | \$/Each | Cat. # | \$/Each | Cat. # | \$/Each | Cat. # | \$/Each |
| For Single Models (2 ports) | 1694-23 | 2,191.00 | 1694-25 | 1,064.00 | 1694-27 | 2,670.00 | 1694-29 | 1,363.00 |
| For Twin Models (4 ports) | 1694-24 | 2,318.00 | 1694-26 | 1,117.00 | 1694-28 | 2,984.00 | 1694-30 | 1,406.00 |

Other Optional Accessories

| | Cat. # | \$/Each | Page |
|---|----------|----------|------|
| Glovebox Dual Purge™ System | 1603-57 | 2,994.00 | 28 |
| NitroWatch™ | 9500-00A | 1,002.00 | 28 |
| NitroWatch Sensor | 9500-02A | 596.00 | 28 |
| Stainless Steel Automatic RB® Valve | 1606-60 | 198.00 | 28 |
| Required for operation with Dual Purge System | | | |
| Accordion Sleeve/Glove Combination | 1681-91B | 311.00 | 26 |
| 18"L, with size 9 gloves (pair) | | | |



Other designs—see page 31

Plastic Glove Port

Standard on all Terra gloveboxes; can be retrofitted on chamber with 11.25" dia. cutouts. Price for single port.

| | Cat. # | \$/Each |
|--------------|---------|---------|
| | 1694-52 | 225.00 |
| Port Covers | 1694-53 | 218.00 |
| Iris Adapter | 1694-54 | 340.00 |

Bag-In/Bag-out Ports — See page 31

Series 500 FULL-VIEW GLOVEBOX

- Transparent front and rear panels ensure full visibility of work in progress
- Opposing glove ports allow convenient, dual-side access
- Large chamber size accommodates bulky process equipment
- Rugged 304 stainless steel top, bottom and sides create a durable, chemical-resistant enclosure
- Select access doors or air locks to allow convenient parts transfer

The Series 500 Glovebox offers several convenient features that reduce the cramped, claustrophobic feeling operators often experience: a spacious processing chamber, transparent full-view windows, and dual-side access to work in progress.

Select windows of polycarbonate or static-dissipative PVC, which helps control surface charges and the particles they attract. All models below include an externally mounted fluorescent illuminator. Terra's 10" -diameter glove ports allow wide arm motion for easier parts manipulation; select gloves separately. Available with a full line of options, including side air locks or access doors for easy parts transfer, stands, and humidity control systems (see below).



Twin Series 500 chambers, No. 1694-32A

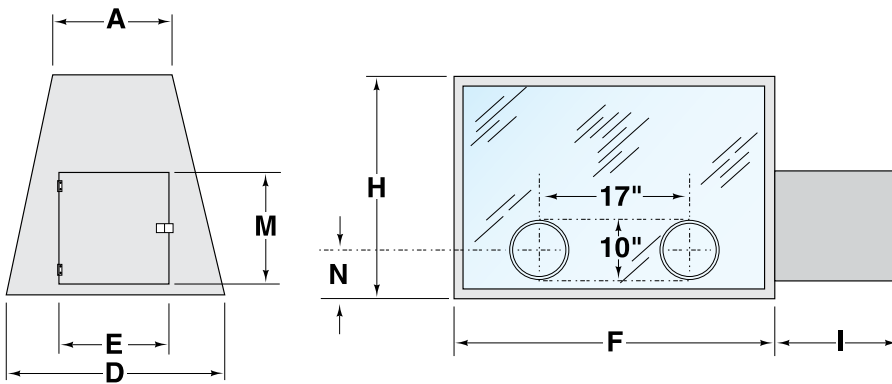

| Glove | A | D | E | F | H | I | M | N |
|-------|----|----|-------|----|----|----|-------|----|
| 2 | 26 | 36 | 14.75 | 48 | 30 | 16 | 14.75 | 12 |
| 4 | 26 | 36 | 14.75 | 96 | 30 | 16 | 14.75 | 12 |

| Series 500 Full-View Gloveboxes* | | | | | Air Locks** | | | Access Door*** | | |
|----------------------------------|-------------------------------|-----------|----------------------|-----------|-------------|------------|----------|----------------|-------------|----------|
| Model | Static-Dissipative PVC Panels | | Polycarbonate Panels | | Right Mount | Left Mount | S/Each | Right Mount | Left Mount | S/Each |
| | Cat. # | S/Each | Cat. # | S/Each | Cat. # | Cat. # | | Cat. # | Cat. # | |
| Single | 1694-31A | 7,870.00 | 1694-33A | 7,752.00 | 1702-12C | 1702-13C | 3,534.00 | 1694-45-500 | 1694-46-500 | 1,183.00 |
| Twin | 1694-32A | 14,537.00 | 1694-34A | 12,316.00 | 1702-12C | 1702-13C | 3,534.00 | 1694-45-500 | 1694-46-500 | 1,183.00 |

* All models are 120VAC, 50/60Hz. For 220VAC, add ~220" to the part number.

** Mounted on either side panel; see page 28 for details.

*** Mounted on either side panel; 18"W x 20"H.

Optional Accessories (see also facing page)



Stands

All-welded 2" square tubing, each stand provides optimal support for its corresponding chamber.

Stainless Steel

Powder-Coat Steel

| For Series 500 Chambers | Cat. # | S/Each | Cat. # | S/Each |
|-------------------------|---------|----------|---------|----------|
| Single | 1694-39 | 2,116.00 | 1694-40 | 1,259.00 |
| Twin | 1684-75 | 2,212.00 | 1684-76 | 1,342.00 |
| For Series 600 Chambers | 9670-02 | 1,385.00 | 9670-03 | 635.00 |



Air Locks

Air locks minimize nitrogen loss and contamination while parts are introduced or removed. BioSeal™ design features noncontaminating polyurethane seals. Standard units on ordering chart above come with solid stainless steel door (select window below).

| Viewing Window | Cat. # | S/Each |
|-----------------------------|---------|--------|
| Tempered Glass, 7"W x 9.5"H | 1702-02 | 487.00 |

Series 600 FRONT-VIEW GLOVEBOX

- Polycarbonate or tempered glass front window allows full view of processing operations
- Stainless steel frame lends strength and chemical resistance
- Select access doors or air locks for convenient parts transfer
- Full range of optional accessories includes gloves, filtration modules and process gas controllers for automatic humidity control

Full-front viewing windows on these chambers provide complete visibility of the processing environment and minimize the claustrophobic sensation created by other gloveboxes. Select chemical-resistant polycarbonate or tempered glass; all units come with a fluorescent illuminator and roomy 10"-diameter glove ports (order gloves separately).



Now with 10"-diameter ports for wider range of motion!

No. 9670-00, shown with right-side air lock.



Optional port cover seals against standard port to allow convenient glove replacement without compromising the internal environment

Cat. # **1694-53** S/Each **218.00**



Optional iris port seals against standard port for easy access by operators with gloved hands

Cat. # **1694-54** S/Each **340.00**

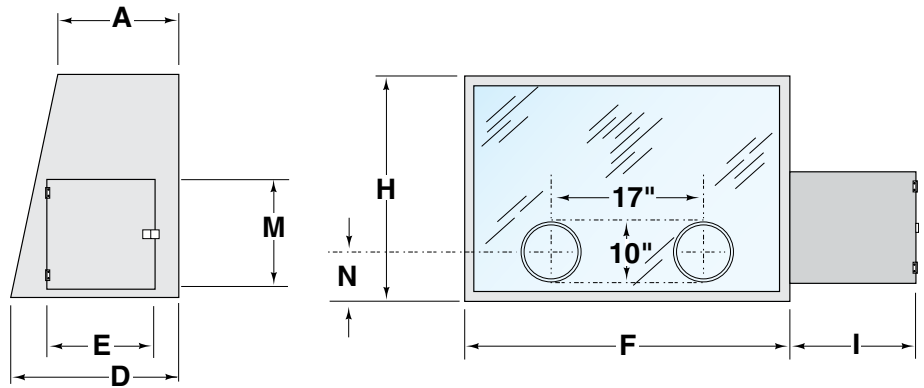

| Glove | A | D | E | F | H | I | M | N |
|-------|----|----|----|------|----|----|----|----|
| 2 | 24 | 29 | 12 | 37.5 | 39 | 16 | 12 | 14 |

| Series 600 Full-View Gloveboxes* | | | | Air Locks** | | | Access Door*** | | |
|----------------------------------|-----------|----------------------|----------|-------------|------------|----------|----------------|-------------|----------|
| Tempered Glass Panels | | Polycarbonate Panels | | Right Mount | Left Mount | | Right Mount | Left Mount | |
| Cat. # | S/Each | Cat. # | S/Each | Cat. # | Cat. # | S/Each | Cat. # | Cat. # | S/Each |
| 9670-01B | 11,196.00 | 9670-00B | 9,759.00 | 1702-14C | 1702-15C | 3,295.00 | 1694-45-600 | 1694-46-600 | 1,183.00 |

* All models are 120VAC, 50/60Hz. For 220VAC, add ".220" to the part number.

** Mounted on either side panel; see page 28 for details.

*** Mounted on either side panel; 18"W x 20"H.

See stands on facing page.

Optional Accessories (see also facing page)



Sleeve and Glove Combination

Neoprene convoluted sleeve provides rigidity that enhances comfort and resists blowback in a pressurized chamber. Supplied with one pair of nitrile gloves of specified size. For 10"-diameter glove ports. See page 26 for other gloves.

| Glove Size | Cat. # | S/Pair |
|------------|---------|--------|
| 8 | 1689-46 | 359.00 |
| 9 | 1689-47 | 343.00 |
| 10 | 1689-48 | 344.00 |

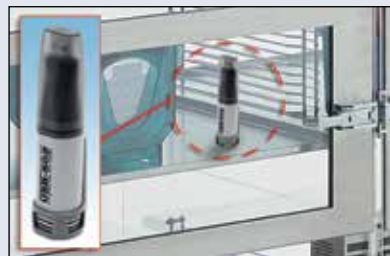

RH/Temperature Data Logger

USP device provides a convenient record of storage conditions. Records data at selected intervals and downloads to computer for display in several formats.

| Cat. # | S/Each |
|---------|--------|
| 9500-10 | 205.00 |

See pages 32 – 33 for Terra's Humidity Control Systems



Swing-up access door and isolated antechamber



Sliding glass door isolates antechamber

COMPOUNDING ASEPTIC ISOLATOR

Helps meet USP<797> requirements

- Low-noise, low-vibration filter/fan unit provides continuous vertical flow of 99.99% particle-free air to meet Class 100 (ISO 5) cleanliness standards
- 304 Stainless steel enclosure is easy to clean and disinfect
- Large, ergonomically sloped static-dissipative PVC viewing window tilts open to allow insertion of filling machines or other large process equipment
- Antechamber features swing door for easy insertion/removal of IV bags and other small items
- Magnehelic® gauge monitors internal positive pressure inside the enclosure that prevents infiltration of contaminants
- Includes IV rod and externally mounted fluorescent illuminator
- Waste port available for disposing of materials through glovebox floor or side



ValuLine™ Isolator provides a USP <797>-compliant isolator at a lower cost! Polypropylene construction is easy to clean and resists biocides. No. 2900-58 shown.

This laminar flow glovebox provides an easy-to-clean environment for performing sterile pharmaceutical preparations. Its HEPA filtration module provides a positive pressure of 99.99% particle-free air inside the work area to meet ISO 5 requirements. A separate antechamber allows introduction of materials without contaminating the main work area. Includes polyurethane exit filter (HEPA exit filter available). Select gloves for 10"-diameter ports from page 26. Material: 304 stainless steel with tempered glass window and polypropylene dividing wall. Dimensions: 50"W x 30"D x 51"H.

Compounding Aseptic Isolators and Stands

| Material | 30" Chamber Depth | | Easy Reach 24" Chamber Depth | |
|---------------|-------------------|----------|------------------------------|----------|
| | Cat. # | \$/Each | Cat. # | \$/Each |
| 304 SS | 2900-46C | 8,294.00 | 2900-56 | 8,447.00 |
| Polypropylene | 2900-62 | 6,496.00 | 2900-58 | 6,650.00 |
| Stand | 1694-81 | 683.00 | 1694-82 | 581.00 |

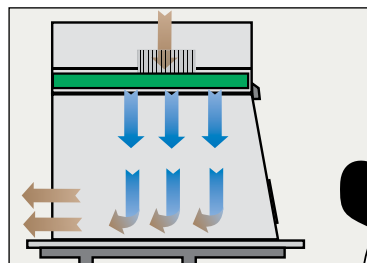

Single-pass flow-through design



Includes IV rod



Gloves — See page 30

Easy-Reach Model: 22" depth allows easy cleaning of back wall; rear baffle plate is removable without rear access to allow easy cleaning and sterilization



Rear Baffle removes for cleaning



Sliding door

Smooth interior with radius corners for easy sterilization!



Available with sloping bottom and drain valve for disinfectant wash-down

No. 9670-32C shown

BIOSAFE® GLOVEBOXES

- Smooth, ultra-clean surfaces eliminate germ traps, simplify cleaning and disinfection
- Continuous-seam interiors create a sealed chamber
- Tempered glass or polycarbonate viewing windows allow full view of chamber
- Includes fluorescent illuminator (UV sterilization bulbs available)
- Optional access panel available for equipment transfer
- Custom configurations available—call to discuss your requirements!

BioSafe Glovebox — All models are 120VAC; 220VAC models available

| Position | Window Material | 304 Stainless Steel | | | | 316 Stainless Steel | | | |
|------------------------------------|-----------------|--------------------------------------|-----------|----------------------------------|-----------|--------------------------------------|-----------|----------------------------------|-----------|
| | | Single (37.5"W x 29"/24"D x 39"H) | | Twin (69"W x 29"/24"D x 39"H) | | Single (37.5"W x 29"/24"D x 39"H) | | Twin (69"W x 29"/24"D x 39"H) | |
| | | Cat. # | S/Each | Cat. # | S/Each | Cat. # | S/Each | Cat. # | S/Each |
| Glovebox with Right-Side Air Lock* | Polycarbonate | 9670-16C | 20,687.00 | 9670-19C | 26,185.00 | 9670-48B | 29,125.00 | 9670-51B | 36,931.00 |
| | Safety Glass | 9670-17C | 21,942.00 | 9670-20C | 27,444.00 | 9670-49B | 30,941.00 | 9670-52B | 38,654.00 |
| Glovebox with Left-Side Air Lock* | Polycarbonate | 9670-22C | 20,656.00 | 9670-25C | 26,223.00 | 9670-54B | 29,125.00 | 9670-57B | 36,931.00 |
| | Safety Glass | 9670-23C | 22,170.00 | 9670-26C | 27,444.00 | 9670-55B | 30,941.00 | 9670-58B | 38,654.00 |
| Glovebox with Dual-Side Air Locks* | Polycarbonate | 9670-28C | 25,904.00 | 9670-31C | 31,654.00 | 9670-60B | 36,700.00 | 9670-63B | 44,550.00 |
| | Safety Glass | 9670-29C | 27,191.00 | 9670-32C | 32,876.00 | 9670-61B | 38,517.00 | 9670-64B | 46,229.00 |

* Air lock dimensions: 16"W x 16"D x 16"H

Each chamber includes pair of 10"-diameter glove ports (twin models include two pairs). Order gloves separately on page 30.

| | For Single | | For Twin | |
|------------------------------|------------|----------|----------|----------|
| | Cat. # | S/Each | Cat. # | S/Each |
| Powder-Coat Stand | 9670-41 | 658.00 | 9670-43 | 789.00 |
| Stainless Steel Stand | 9670-40 | 1,385.00 | 9670-42 | 1,519.00 |

Removable Panel

Allows you to remove and reseal front viewing window to allow transfer of large process equipment. Poured polyurethane BioSeal™ is easy to clean and sterilize.

| | Cat. # | S/Each |
|----------------|---------|----------|
| Single Chamber | 9670-35 | 2,894.00 |
| Twin Chamber | 9670-36 | 3,473.00 |

Filtration Module

Versatile system allows easy conversion from open-loop operation with fresh make-up air, to closed-loop recirculation for particle containment: just turn the valves. An inlet and outlet ULPA filter scrubs the air of contaminants, maintaining cleanliness.



See Page 8 for more details and ordering information.

Nitrogen Generators

Purity vs. Flow Rates (@100 PSI inlet feed, 72°F*)

| Model | 99% | 98% | 97% |
|--------------|-----------|-----------|-----------|
| No. 2700-12A | 7.4 CFH | 10.2 CFH | 12.5 CFH |
| No. 2700-11A | 49.0 CFH | 65.0 CFH | 75.0 CFH |
| No. 2700-09A | 126.0 CFH | 180.0 CFH | 223.0 CFH |

* Higher flow rates can be achieved with higher feed temperature (see Terra's process gas heater, No. 9450-00).



PROCESS GAS GENERATORS & DRYERS

Terra's gas generators and gas dryers provide several ways to produce a dry, particle-free environment inside glove boxes, desiccators, and other enclosures.

Membrane separation systems operate with no moving parts and require almost no maintenance. The Nitrogen Generator uses this technology to provide a reliable source of clean, dry nitrogen.

On-Site Generation – a simple, reliable, hassle-free alternative to rented tanks that guarantees you'll never run out of clean, dry Nitrogen!

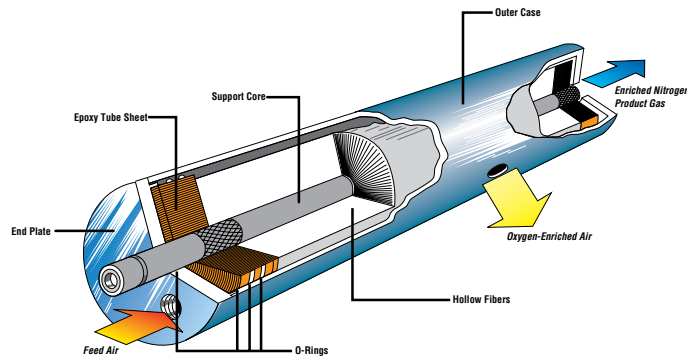

Comparative Guide to Terra Gas Dryers

| Product | Design Type | Outlet Flow Capacity | Service Requirement | Prefilters Included | Overall Dimensions (W" x D" x H") | Recommended Application | Cat. # | S/Pair |
|------------------------|-------------|-----------------------------|---------------------------|--------------------------------|-----------------------------------|---|----------|-----------|
| A. Nitrogen Generator | Membrane | See performance chart above | Air Compressor (#9505-47) | Yes (micro-fiber & coalescing) | 18 x 18 x 81.25 | Gloveboxes, desiccators & N ₂ -based process equipment in labs where N ₂ is preferable to dry air | 2700-09B | 15,360.00 |
| | | | | | 24 x 12 x 49.25 | | 2700-11B | 6,847.00 |
| | | | | | 20 x 12 x 35.5 | | 2700-12B | 5,509.00 |
| B. Dryex 80™ Gas Dryer | Membrane | 420-900 SCFH | Air Compressor (#9505-43) | Yes (micro-fiber & coalescing) | 24 x 12 x 49.25 | Low-humidity applications (in gloveboxes or desiccators) where clean, dry air is acceptable | 9082-00 | 5,194.00 |
| C. Dryex 10™ Generator | Membrane | 54-105 SCFH @ 100 PSIG | Air Compressor (#9505-43) | Yes (micro-fiber & coalescing) | 16 x 7.25 x 6.5 | Ideal source of purged gas in moisture-sensitive storage and processing applications | 9082-01 | 2,699.00 |

HIGH-CAPACITY NITROGEN GENERATOR

- Turnkey solution supplies high-volume of 99%+ pure nitrogen for laboratory or industrial applications*
- Compressor processes clean, dry air for nitrogen production
- Eliminates limitations of conventional nitrogen sources—gives you control of rate, purity and cost of nitrogen production
- Large nitrogen holding tank ensures a ready supply at all times
- Modular design allows easy accessibility of all components for required maintenance

Terra Universal's High-Capacity Nitrogen Generator includes both a high-volume rotary screw air compressor and Terra nitrogen* tanks/membranes for a complete system. Simply allow the holding tank to fill, and you've got 60 gallons of N₂ ready to use. Easily and quickly replenish as needed. The generator is designed to provide a continuous flow of 99%+ pure nitrogen without the expense and inconvenience associated with gas cylinders. The rotary-screw air compressor features a direct-drive, energy-efficient 50 HP motor, with a moisture separator for cleaner air. Operating at 217 psig, it produces 157 ACFM. For N₂ production, the compressed air passes through the generator's coalescing filters to remove residual water, oil and particles. Hydrocarbon filters then remove vapors before the final step of separation from other gasses such as oxygen and carbon dioxide. Purified nitrogen is stored and ready to use.



High Capacity Nitrogen Generator, 120VAC, No. 2701-32



High-capacity Rotary Screw Air Compressor No. 2701-33

Specifications

| | |
|----------------------------------|--|
| Nitrogen Purity: | 99%+ (depending on inlet pressure) |
| Power Requirements (compressor): | 208/230/460 VAC, 60Hz, 3-phase, prewired for 460V operation |
| Power Requirements (generator): | 120VAC / 240VAC |
| Generator Max. Power: | 4kW |
| Footprint: | 90" x 72" (generator and compressor) |
| Maximum height: | 96" |
| Generator Tank Capacity | N ₂ holding tank: 60 gal.; Compressed air storage: 200 gal. |
| Compressor pressure range | 217 psig |
| Compressor Capacity | 157 ACFM |
| Compressor Motor Power | 50 HP |
| Compressor Dimensions | 78.375"L x 40.5"W x 67"H |
| Compressor Weight | 2,458 lb |

| | Cat. # | S/Each | |
|---|----------------|----------------|------------------|
| High-Capacity Nitrogen Generator | 120 VAC | 2701-32 | 17,850.00 |
| Compressed Air System | 208/230/460VAC | 2701-33 | 26,000.00 |

* See performance data at TerraUniversal.com for correlated flow.

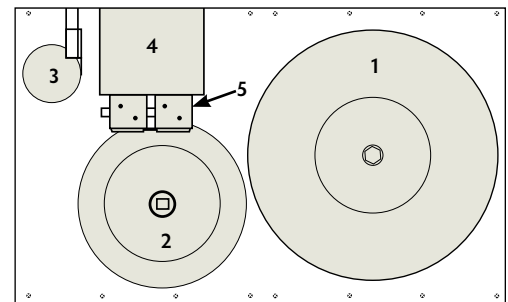

Top view of component configuration inside nitrogen generator powder-coated steel cabinet

Nitrogen Generator System Components:

- 1 200-gallon compressed air holding tank
- 2 60-gallon nitrogen holding tank
- 3 Hydrocarbon filter
- 4 Two (2) nitrogen membranes and one (1) exit filter
- 5 Coalescing pre-filters
- 6 High-volume rotary screw compressor

A Reliable Nitrogen Source When You Need It!

Nitrogen's (N₂) inert properties make it a necessity for many industries, such as life science, semiconductor, aerospace, food, chemicals, and energy. It's widely used for drying, purging, cooling, and to create a protective barrier between sensitive parts and the damaging environment (i.e., oxygen). High-volume N₂ production is an effective process that eliminates limitations and higher cost of N₂ canisters.

STAINLESS STEEL AIR LOCKS

- Smooth internal surfaces and all-welded seams for easy cleaning and disinfection
- No-lip design maximizes usable space
- Non-contaminating polyurethane Bio-Seal™

Terra's improved air lock design ensures a sealed environment that minimizes nitrogen loss and contamination. Knife-edges along the chamber seat against recessed polyurethane seals. Double-wall stainless steel construction, with heavy-duty door latches and hinges, ensures a long service life.

Select optional safety glass viewing window on the access side. Mechanical interlocks are also available to prevent the chance of cross-contamination. Includes provisions for purging with nitrogen or other process gas, and for installation of an Automatic RB® (Relief/Bleed) valve.



Optional mechanical interlocks: Cat. # 1702-03, \$460

Elastomer seal for superior performance

Cleaner, More Durable Stainless Steel Latches
Terra's all-stainless steel latches, standard on all glovebox air locks, eliminate scratching, corrosion and contamination common with plated latches.

| Dimensions (D): | 12"W x 12"H x 14"D | | | 12"W x 12"H x 16"D | | | 16"W x 16"H x 16"D | | | 12"W x 20"H x 16"D | | |
|----------------------|--------------------|------------|----------|--------------------|------------|----------|--------------------|------------|----------|--------------------|------------|----------|
| | Right Mount | Left Mount | S/Each | Right Mount | Left Mount | S/Each | Right Mount | Left Mount | S/Each | Right Mount | Left Mount | S/Each |
| For Glovebox | Cat. # | Cat. # | S/Each | Cat. # | Cat. # | S/Each | Cat. # | Cat. # | S/Each | Cat. # | Cat. # | S/Each |
| Series 300 (page 18) | 1702-10C | 1702-11C | 3,534.00 | 1681-17C | 1681-18C | 3,810.00 | — | — | — | — | — | — |
| Series 400 (page 20) | 1698-01C | 1698-02C | 3,350.00 | 1681-19C | 1681-89C | 3,810.00 | 1702-18C | 1702-19C | 5,062.00 | 1702-37C | 1702-38C | 4,316.00 |
| Series 500 (page 22) | 1702-12C | 1702-13C | 3,534.00 | 1681-93C | 1681-94C | 3,810.00 | 1702-31C | 1702-32C | 5,062.00 | 1702-39C | 1702-40C | 4,316.00 |
| Series 600 (page 23) | 1702-14C | 1702-15C | 3,295.00 | 1681-95C | 1681-96C | 3,810.00 | 1702-33C | 1702-34C | 5,062.00 | 1702-41C | 1702-42C | 4,316.00 |

* Part numbers are for an air lock of the specified size with a flange for right or left mounting to the Terra glovebox indicated. (No part numbers in a column indicates that the air lock does not fit that glovebox).



Shown with custom rear-wall installation



Door sealed in housing outside chamber

PNEUMATIC DOOR AIR LOCKS

Foot pedal operation eliminates awkward reaching—perfect for large chambers

This pneumatic access door eliminates clearance requirements—giving you full use of every square inch of valuable glovebox space. The pneumatic assembly and all moving parts are positioned outside the glovebox in a separate housing. Can be configured for rear chamber access or air lock access.

| Corresponding Glovebox | Right Side | | Left Side | |
|------------------------|------------|----------|-----------|----------|
| | Cat. # | S/Each | Cat. # | S/Each |
| For Series 300 Chamber | 1530-70 | 7,583.00 | 1530-74 | 7,667.00 |
| For Series 400 Chamber | 1530-71 | 7,752.00 | 1530-75 | 7,837.00 |
| For Series 500 Chamber | 1530-72 | 7,920.00 | 1530-76 | 8,004.00 |
| For Series 600 Chamber | 1530-73 | 8,087.00 | 1530-77 | 8,174.00 |

PASS-THROUGH OVENS & ACCESS MODULES

A. High-Performance Pass-Through Oven

Features double doors for such pass-through operations as resistance and seam welding of hybrids and many other microelectronic packages. Door flanges hold circulating water to speed up the cooling of the chamber during cycling operations. These ovens require a support platform when mounted on a chamber; select a Terra stand with oven support. Select fittings kit for operation with Full-Vacuum Control Module.

Temperature range: Up to 300°C continuous, 350°C intermittent
Degree of vacuum: Up to 10⁻⁶ Torr and higher.

| | Right Mount Cat. # | Left Mount Cat. # | S/Each |
|-------------|-----------------------|----------------------|-----------|
| 120VAC/60Hz | 5401-12A | 5401-00A | 18,131.00 |
| 220VAC/50Hz | 5401-12A-220 | 5401-00A-220 | 18,131.00 |



Heating to 300°C



Heating to 149°C, see TerraUniversal.com for other sizes

B. Modular Vacuum/Nitrogen Oven

This unit provides a compact, economical alternative to Terra's larger Vacuum/Nitrogen Oven. It is ideal for R&D, lab, and production operations.

Vacuum range: Atmosphere to 10 microns, with adequate pump
Temperature range: 10°C to 149°C
Capacity: 0.48 cu. ft.

| | Right Mount Cat. # | Left Mount Cat. # | S/Each |
|-------------|-----------------------|----------------------|----------|
| 110VAC/60Hz | 9602-30A | 9602-03A | 6,134.00 |
| 240VAC/50Hz | 9602-30A-220 | 9602-03A-220 | 6,134.00 |



C. Vacuum Control Module

Controls vacuum pump operation to maintain desired vacuum level inside the Series 400 vacuum antechamber or pass-through oven. See page 20.

| | Cat. # | S/Each |
|--------|-------------|----------|
| 120VAC | 1681-75 | 2,878.00 |
| 240VAC | 1681-75-220 | 2,878.00 |



D. Acrylic Vacuum Antechamber

Supports vacuum to 29.9" Hg. Available in plastic for Series 100/200/300 Glovebox.

| | Cat. # | S/Each |
|-----|---------|----------|
| 12" | 1681-63 | 3,052.00 |
| 23" | 1681-67 | 3,696.00 |

E. Bellows Eyepiece Interface

This cut-out is sealed with a bellows-type diaphragm to allow viewing of a stereo microscope positioned inside any of Terra's stainless steel gloveboxes. Standard cut-out size is 8"W x 6"H. Specify size and location.

| Cat. # | S/Each |
|---------|--------|
| 1681-53 | 246.00 |

F. Flanges and Pipe Fittings

Terra provides a wide range of pipe and flange fittings, including Tri-Clover Flange Adapters, to accommodate glovebox feed or ventilation ports. Call to discuss your requirements.

- Weld-On and Bolt-On Configurations, all diameters
- 304/316 SS, brass and other materials
- PTFE and other linings



G. Tilt-Up Viewing Module

Swings open for easy access. Dual piston mechanisms hold the window securely in open. Price includes modification of plastic or stainless steel glovebox. Frame is stainless or powder-coat steel; window is static-dissipative PVC. Must be ordered together with affected glovebox.

| Glovebox Material | Single Chamber | | Twin Chamber | |
|----------------------------|----------------|----------|--------------|----------|
| | Cat. # | S/Each | Cat. # | S/Each |
| Plastic: SS Frame | 3305-20 | 2,490.00 | 3305-21 | 2,953.00 |
| Plastic: Powder-coat Frame | 3305-22 | 2,142.00 | 3305-23 | 2,605.00 |
| Stainless Steel | 1684-92 | 2,067.00 | 1684-93 | 2,376.00 |

All models for 10"-diameter ports



GLOVES & SLEEVE COMBINATIONS

A. Accordion Sleeve and Glove

These accordion sleeves, made of neoprene, can be used for any size and type of gloves. The convenient two-piece design lets you change glove sizes and types for different operators or applications without the expense of changing the sleeve itself. The corrugated section keeps the sleeve off the operator's arm for better air circulation and greater comfort. Includes nitrile gloves. Glove Thickness: 18 mil.

| Glove Size | 18" Sleeve, 12.75" glove | |
|------------|--------------------------|---------------|
| | Cat. # | S/Pair |
| 8 | 1689-46 | 359.00 |
| 9 | 1689-47 | 343.00 |
| 10 | 1689-48 | 344.00 |

B. Heavyweight Nitrile Gloves

These heavy-duty nitrile rubber gloves provide unusual durability while maintaining optimum levels of form, fit and function. Resists a wide-range of chemicals, including solvents

| Glove Size | 13" Sleeve | |
|------------|----------------|-------------|
| | Cat. # | S/Pair |
| 8 | 1671-50 | 6.00 |
| 9 | 1671-51 | 6.00 |
| 10 | 1671-52 | 6.00 |

BUY ONLINE! Items priced in blue usually ship in 1-3 days.

C. Butyl Sleeve and Glove

Textured grip improves dexterity. Length: 32".

| Hand Size | One-Piece Fully-Dipped Glove | | | |
|-----------|------------------------------|---------------|----------------|---------------------|
| | Lightweight (.015") | | | Heavyweight (.030") |
| | Cat. # | S/Pair | Cat. # | S/Pair |
| 9 | 1671-15 | 347.00 | 1671-16 | 384.00 |

D. Nitrile Sleeve and Glove

Two-piece units provide the convenience of quick glove replacement. Sleeve has GUS. (Glove-Under-Sleeve) Connectors to air-tight, liquid-tight seal. Unlined.

| Hand Size | Nitrile Gloves 13" long | | Nitrile Sleeve 22" long | |
|-----------|-------------------------|--------------|-------------------------|---------------|
| | Cat. # | S/Pair | Cat. # | S/Pair |
| 8 | 1670-13 | 50.00 | 1670-17 | 202.00 |
| 9 | 1670-14 | 50.00 | Sleeve has GUS | |
| 10 | 1670-15 | 50.00 | Connector (see above) | |

E. Neoprene Sleeve and Glove

Select one-piece bonded or two-piece sleeve/glove combinations. Two-piece units provide the convenience of quick, easy glove replacement while leaving the sleeves attached to the glovebox. Sleeve and glove are joined by a Glove-Under-Sleeve (GUS) Connector, which ensures an air-tight, liquid-tight seal and protection against hazardous materials. Length: 30" total (22" sleeve only, tapering to a 4"-diameter cut-off). Sleeve thickness: 0.030" – 0.040".

F. Hypalon Sleeve and Glove

Select one-piece fully-dipped glove or two-piece sleeve/glove combinations. Two-piece units provide the convenience of quick, easy glove replacement while leaving the sleeves attached to the glovebox. Sleeve and glove are joined by a Glove-Over-Sleeve (GOS) Connector, which ensures an air-tight, liquid-tight seal and easy glove changeout. Length: 32" total (22" sleeve only, tapering to a 4"-diameter cut-off). Sleeve thickness: 0.015".

E. Neoprene Gloves for 10"-diameter ports

| Hand Size | One-Piece Bonded Neoprene Dry Box Glove | | Neoprene Gloves 13" long, unlined textured grip | | Neoprene Sleeve Sections 22" long | |
|-----------|---|---------------|---|--------------|------------------------------------|---------------|
| | Cat. # | S/Pair | Cat. # | S/Pair | Cat. # | S/Pair |
| 8 | 1689-53 | 241.00 | 1670-83 | 68.00 | 1690-92 | 197.00 |
| 9 | 1689-55 | 241.00 | 1670-84 | 68.00 | with G.U.S. connectors (see above) | |
| 10 | 1689-56 | 241.00 | 1670-85 | 68.00 | | |

F. Hypalon Gloves for 10"-diameter ports

| Hand Size | One-Piece Fully-Dipped Hypalon Dry Box Glove | | Hypalon Gloves 14" long, unlined textured grip | | Hypalon Sleeve Sections 22" long | |
|-----------|--|---------------|--|--------------|----------------------------------|---------------|
| | Cat. # | S/Pair | Cat. # | S/Pair | Cat. # | S/Pair |
| 8 | — | — | 1671-05 | 82.00 | 1671-18 | 362.00 |
| 9 | 1671-17 | 330.00 | 1671-06 | 82.00 | — | — |
| 10 | — | — | 1671-07 | 82.00 | — | — |

GLOVE & IRIS PORTS

- 10"-diameter ports, standard on all Terra gloveboxes, allow ample arm motion
- Internal mounting system accepts port caps or iris ports, which seal against the port frame to expand glovebox versatility (order caps and iris ports separately)

Versatile Three-Part System

Terra's standard 10"-diameter glove ports, made of ABS plastic, accommodate all the gloves on the facing page. Their versatile internal mounting hardware allows you to expand system capabilities by adding either port covers or iris ports.

Port covers include an O-ring that seals tightly against the glove ports from the inside of the chamber. This internal-mount system lets you seal a chamber when work is not in process, and to replace gloves without affecting the internal environment. Handles allow easy manipulation of the caps.

Iris ports also mount against the ports from the inside, converting the chamber into an easy-access, non-sealed chamber that operators can access using standard laboratory gloves.

Replacement Glove Port

Required for either caps or iris ports. Included standard on all Terra gloveboxes. Price is for one port.



New larger-diameter ports provide a wider range of motion to improve comfort and productivity!

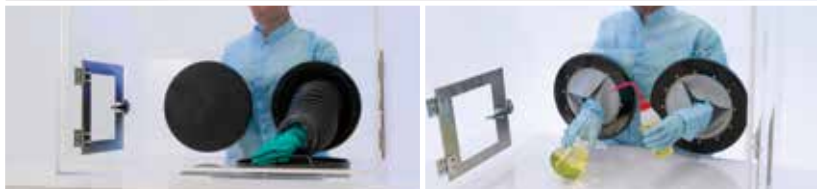

Optional port cover seals against port to allow glove replacement without compromising the internal environment

Optional iris port seals against port for easy access by operators with gloved hands



Cat. # **1694-52** S/Each **225.00**



Port Cover

Mounts to a standard 10"-diameter port. Price is for one cover.

Cat. # **1694-53** S/Each **218.00**



Iris Port

Includes iris port and port retaining ring. Mounts to standard 10"-diameter port. Price is for one iris port.

Cat. # **1694-54** S/Each **340.00**

SPECIALTY GLOVE PORTS

- Round or oval, in 304/316 stainless steel, PVC, polypropylene, and more
- Custom materials and configurations, including Delrin® ports and Viton® or Buna-N O-rings: TerraUniversal.com



| 304 Stainless Steel Ports (316L pharmaceutical-grade SS also available) | | | | |
|--|---------|--------|---------|--------|
| Diameter | Round | | Oval | |
| | Cat. # | S/Each | Cat. # | S/Each |
| 8" | 1672-05 | 460.00 | — | — |
| 9" | 1672-06 | 620.00 | 1672-10 | 861.00 |
| 10" | 1672-07 | 772.00 | 1672-11 | 924.00 |
| 12" | 1672-08 | 899.00 | 1672-12 | 988.00 |

| PVC Ports | | |
|-----------|---------|--------|
| Diameter | Round | |
| | Cat. # | S/Each |
| 6" | 1672-15 | 321.00 |
| 8" | 1672-16 | 339.00 |
| 10" | 1672-17 | 375.00 |
| 12" | 1672-18 | 411.00 |

| Polypropylene Ports | | | | |
|---------------------|---------|--------|---------|--------|
| Diameter | Round | | Oval | |
| | Cat. # | S/Each | Cat. # | S/Each |
| 6" | 1672-21 | 411.00 | — | — |
| 8" | 1672-22 | 494.00 | 1672-27 | 494.00 |
| 10" | 1672-23 | 494.00 | — | — |
| 12" | 1672-24 | 499.00 | — | — |

Bag-Out Port

9" diameter. Other sizes available.

Bags: Package of 10 12-mil PVC bags for 9" port

| Cat. # | S/Each |
|---------|--------|
| 1694-43 | 287.00 |
| 1694-44 | 109.00 |

PROCESS GAS & HUMIDITY CONTROLS



Economizes on nitrogen consumption up to 78%

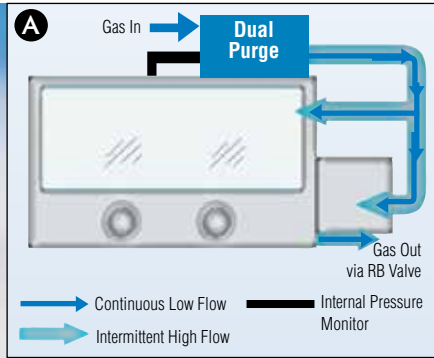

Extends shelf lives of stored materials by controlling moisture and moisture-related defects

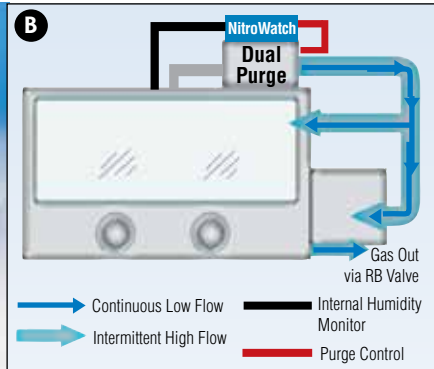

DewWatch: Humidity Monitor & Control (Dual Purge System, RB valve required)

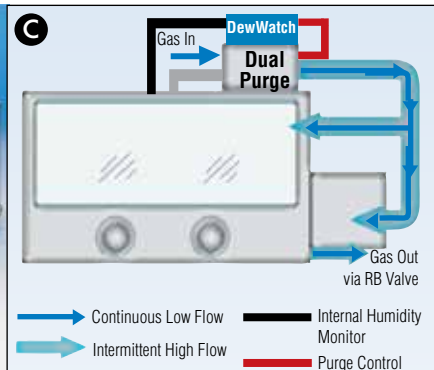

Typical application with NitroWatch/Dual Purge humidity controllers (not included)

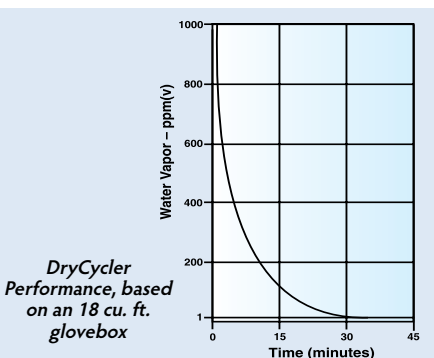
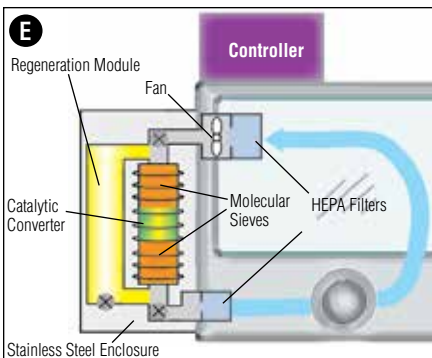
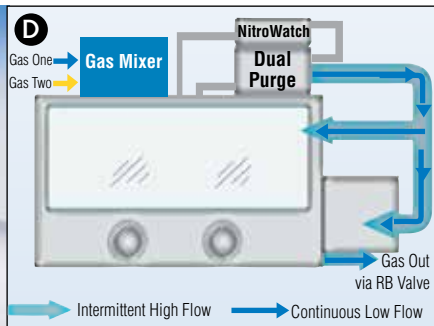

A. Dual Purge™ System

Purges a glovebox with dry process gas to maintain a continuous positive pressure that blocks out moisture and contaminants. Switches to high-flow purge to compensate for pressure drop-outs or rising humidity levels. Requires RB valve for safe operation.

| | | |
|---|---------|----------|
| 110VAC, 60Hz or 220VAC, 50Hz High-Flow System | Cat. # | \$/Each |
| | 1603-57 | 2,994.00 |
| | 1603-58 | 3,341.00 |

For rapid purge required in low-O₂ chambers.

B. NitroWatch™

Operates in tandem with the Dual Purge System to maintain user-determined humidity level (down to 0%RH).

| | | |
|-----------------|----------|----------|
| Control Unit | Cat. # | \$/Each |
| | 9500-00A | 1,002.00 |
| Humidity Sensor | 9500-02A | 596.00 |

C. DewWatch™ Hygrometer

A high-performance alternative to the NitroWatch, this unit monitors and displays dew/frost points between -80 and +20 degrees C. Sensor is sensitive to 0.5 PPM(v) of moisture.

| | | |
|--------------|---------|----------|
| Control Unit | Cat. # | \$/Each |
| | 1401-07 | 5,225.00 |
| Sensor Probe | 1401-12 | 1,703.00 |

D. Trace Gas Mixer™

Assures accurate gas mixtures. Model shown features two flow channels of specified flow.

| | | |
|-------------|---------|----------|
| | Cat. # | \$/Each |
| 2-20/2-20 | 2701-00 | 983.00 |
| 2-20/5-50 | 2702-00 | 1,001.00 |
| 5-50/5-50 | 2703-00 | 1,019.00 |
| 5-50/10-100 | 2704-00 | 984.00 |

E. DryCycler™ Regenerating Gas Dryer

Quickly provides an ultra-low humidity level (down to 1 ppm of water vapor) inside a glovebox or other enclosure. A humidity controller activates the dehydration module to maintain humidity set point.

| | | |
|--|---------|-----------|
| | Cat. # | \$/Each |
| | 6706-01 | 15,814.00 |

F. Automatic RB® (Relief/Bleed) Valve

Automatically relieves pressure build-ups to ensure safe operating conditions with Terra's gas control systems.



For Stainless Steel Enclosures

| | | |
|--|---------|---------|
| | Cat. # | \$/Each |
| | 1606-60 | 198.00 |

For Polymer Enclosures

| | | |
|--|----------|---------|
| | CAT. # | \$/EACH |
| | 1600-60B | 104.00 |



G. Humex Humidifiers

Terra's Humex Humidification Modules allow controlled moisture testing in a glovebox or other chamber. The Humex incorporates a water reservoir for high-volume applications. The Humex 2™ humidifies the nitrogen or other process gas being fed into the chamber. It is plumbed to a standard water line and includes a vaporization chamber that provides 15 – 30 CFH flow rate. Both require a humidity sensor for automated humidity control with ± 3% accuracy. Visit TerraUniversal.com for full specifications.



| | Cat. # | \$/Each |
|-----------------------------|----------|----------|
| Humex (110VAC, 50/60Hz) | 9081-00 | 4,552.00 |
| Humex 2 (110VAC, 50/60Hz) | 9081-02 | 2,602.00 |
| Humidity Sensor (installed) | 9500-02A | 596.00 |

H. Trace Oxygen Analyzer

This Trace Oxygen Analyzer utilizes precise zirconia oxide diffusion sensors to accurately detect oxygen concentrations, making it ideal for applications in which even minute concentrations of oxygen can degrade parts. With a user-friendly, menu-driven microprocessor and a quick response time, this Oxygen Analyzer is capable of measuring from 0.01ppm to 100% oxygen with a high degree of accuracy. An RS232 interface is included.

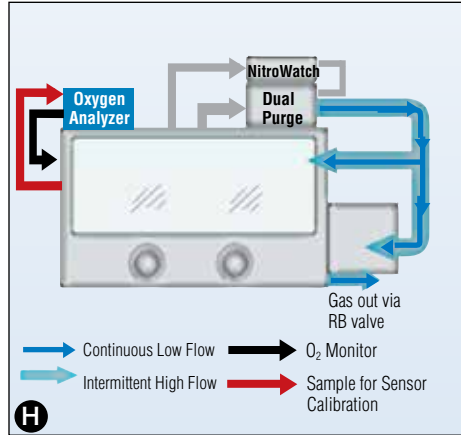

Typical application with NitroWatch/Dual Purge humidity controllers (not included)

The control housing contains: the electronics module, the sensor, the sample cell, and a high-purity pump that draws gas from the glovebox for analysis. It includes a high-visibility LED digital display that indicates oxygen concentration.

| | |
|--------------------|--|
| Sensor: | Quick response zirconia oxide diffusion sensor |
| Measurement Range: | Autoranging from 0.01 ppm to 100% |
| Accuracy: | 1% or better of measured value in ppm |
| Repeatability: | 0.2% of measured value |
| Response Time: | 90% of step change within 5 seconds |
| Power: | User selectable 110/220VAC, 50/60Hz |

Includes connection to specified glovebox.

| | | |
|-----------------------|---------|----------|
| Trace Oxygen Analyzer | Cat. # | \$/Each |
| | 2005-97 | 6,864.00 |

CO₂ Analyzer also available

I. RH/Temperature Data Logger

This USB device provides a convenient record of humidity and temperature conditions inside the process chamber. You set the logging interval (from 10 seconds to 12 hours), units (°C or °F) and hi/low alarms; the device stores up to 16,382 temperature and RH readings. Included software lets you download data via USB port and then display it as a strip chart or export to an MSExcel® spreadsheet. Only 4" long, the unit is powered by a single 3.6V Li battery.

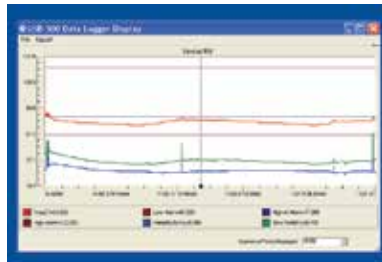

| | |
|---------|---------|
| Cat. # | \$/Each |
| 9500-10 | 205.00 |

J. Programmable Logic Controllers

Terra configures and programs Allen-Bradley PLCs for a wide range of process applications involving temperature, humidity, UV sterilization, and other control variables. Capabilities include touchscreen monitor/control of process recipes and ramp cycles.

Call to discuss your process requirements!





WE'RE MORE THAN CLEANROOMS. WE'RE WHAT GOES INSIDE.

For over 35 years, Terra has manufactured critical environment enclosures and furnishings. We also offer unbeatable value and technical service on a comprehensive range of laboratory research and processing equipment.

For detailed technical specifications and pricing, visit Terra's sister site Laboratory-Equipment.com.



A. BACTRONEZ

Modular and economical BACTRONEZ anaerobic chambers can be configured to your specific application requirements. The patented cuffs enable glove-free handling and inspection of samples within a consistent, oxygen-free environment. These anaerobic chambers provide a faster sample turnaround compared to vacuum jars and bags. Units are ideal for research and clinical laboratories handling small volumes of anaerobic samples.

Includes: Sleeve assembly with medium cuff and interior electrical outlet

BACTRONEZ 13.7 cu. ft., 300 plate

| Description | Cat. # | S/Each |
|--------------------|-------------|-----------|
| 13.7 cu. ft., 110V | 3901-00 | 10,893.00 |
| 13.7 cu. ft., 220V | 3901-00-220 | 10,893.00 |

See Essential Accessories Kit



A Modular unit with 13.7 cu. ft. work space and a 300-Petri plate capacity

B. BACTROX Hypoxia Chamber

The Bactrox Hypoxia Chamber provides precise control of oxygen and carbon dioxide from a range of 1% to 20% and in increments of 1/10th of a percent.

- Advanced atmospheric PID controller
- Independent incubator (5°C above ambient to 70°C)
- Ultra-fast extra large pass box, vacuum-less sleeve entry
- Vibrant LED exam lights; stainless steel construction
- Independent gas and condensation control
- RSS232; Condensation control; PC calibration of oxygen sensor; independent gas controls

BACTROX Hypoxia Chamber, 13.7 cu. ft.

| Description | Cat. # | S/Each |
|--------------------|-------------|-----------|
| 13.7 cu. ft., 110V | 3900-87 | 20,776.00 |
| 13.7 cu. ft., 220V | 3900-87-220 | 20,776.00 |



B 13.7 cu. ft. and 300-plate capacity unit provides precise control of oxygen and carbon dioxide

Accessories

C. BACTRONEZ Essential Accessories Kit

- Includes: vacuum pump, foot pedal assembly, AMG regulator, ergonomic grip catalyst holder, exterior LED light, Petri plate racks (2 x 11)
- Unit Weight: 65 lbs. (29.48 kg)

BACTRONEZ Essential Accessories Kit

| Description | Cat. # | S/Each |
|-------------|-------------|----------|
| 115V | 3901-25 | 2,898.00 |
| 220V | 3901-25-220 | 2,898.00 |

D. BACTRON Sleeve Assembly

For BACTRON and BACTROX chambers. Includes sleeves, cuffs and O-rings

| Cuff Size | Arm Port Door | Cat. # | S/Each |
|-----------|---------------|---------|--------|
| Large | Ergonomic | 3901-02 | 483.00 |
| Medium | Ergonomic | 3901-04 | 483.00 |
| Small | Ergonomic | 3901-06 | 483.00 |

E. Anaerobic Chamber Start-Up Kit

Start-up kit includes: spare gasket, anatox, chamber cleaner, scratch remover, acrylic cleaner, 10 anaerobic indicator strips, 2 sets of spare latex cuffs and spare O-ring.

| For use with | Cat. # | S/Each |
|----------------------|---------|--------|
| BACTRONEZ | 3901-01 | 478.00 |
| BACTRON300, 600, 900 | 3900-93 | 356.00 |



C Includes all the most used accessories for the BACTRONEZ



D



E

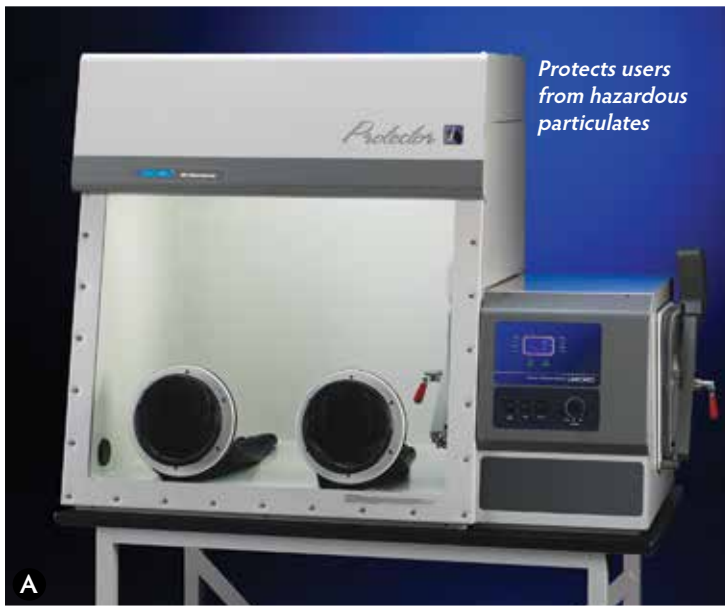

A. Protector® Filtered Glove Boxes

The inlet and outlet filters (HEPA or ULPA) provide optimum user protection from extremely hazardous particulates. Airborne particulate containment, with reversible air pressure from negative to positive, allows units to be used in cleanroom applications requiring ISO Class 3 conditions and exceeds ISO Class 5 conditions. These units are durably constructed with either stainless steel (ULPA) or one-piece molded fiberglass (HEPA) liners for a leak-tight isolation of hazardous or sensitive materials such as: microorganisms, low-level radio-chemicals, chemical carcinogens and asbestos. Features: inner and outer transfer chamber doors, built-in blower with speed control, pass-through plug, neoprene gloves, LCD real time display, epoxy-coated exterior and large laminated safety glass window. Dimensions: 63.5"W x 31.0"D x 45.7"H. Select models are ETL listed or CE marked. Model shown: 3644-00.

Applications nanoparticle manipulation, toxic powder weighing, pharmaceutical research and biochemistry

| Type | Material | Cat. # | \$/Each |
|-------------------------------|---------------------|-----------------|------------------|
| Single Models (2 glove ports) | 304 Stainless Steel | 3644-01* | 21,036.00 |
| | Fiberglass | 3644-00* | 16,794.00 |
| Twin Model (4 glove ports) | 304 Stainless Steel | 3644-02* | 42,169.00 |

* 120 VAC, 60 Hz Models; 220V models also available



B. Protector Controlled Atmosphere Glove Boxes

These leak-tight, factory-tested units provide an impermeable environment that effectively isolates highly sensitive material from contamination. Ambient air inside the glove box is replaced with an inert gas (nitrogen, argon or helium) delivered manually or automatically (auto pressure controller model). Units are durably constructed with either stainless steel or one-piece molded fiberglass with both models achieving ISO Class 1 atmosphere conditions. Features: large laminated safety glass window, epoxy-coated steel exterior, LCD display (with auto pressure controller models), 4 inlet/outlet valves, neoprene gloves, and pass-through with plug. Dimensions: 63.9"W x 34.4"D x 45.7"H. Select models are ETL listed or CE marked. Model shown: 3644-07.

Applications: organometallic chemistry, lithium battery handling, hemoglobin research. hydrophilic chemical handling.

| Type | Material | Cat. # | \$/Each |
|-------------------------------|---------------------|-----------------|------------------|
| Single Models (2 glove ports) | 304 Stainless Steel | 3644-07 | 21,608.00 |
| | 304 Stainless Steel | 3644-08* | 27,617.00 |
| | Fiberglass | 3644-05 | 17,379.00 |
| | Fiberglass | 3644-06* | 23,571.00 |
| Twin Model (4 glove ports) | 304 Stainless Steel | 3644-09 | 43,107.00 |
| | 304 Stainless Steel | 3644-10* | 48,827.00 |

120 VAC, 60 Hz models listed above; 220V models also available

* With Auto Pressure Control

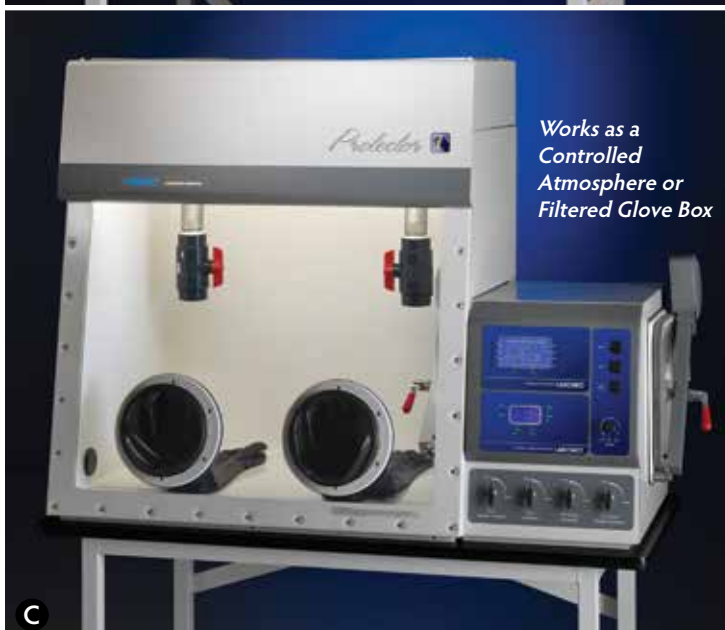

C. Protector Combination Glove Boxes

These glove boxes have two internal valves that convert models from a flow-through to an inert atmosphere glove box. Units are constructed with a leak tight physical barrier and an inlet and outlet HEPA or ULPA filtration to protect users working with hazardous or sensitive samples. Features: Exceeds ISO Class 4, achieves ISO Class 3, surpasses ASHRAE 110 standards, exceeds ISO Class 1, factory leak-tested, large laminated safety glass window, epoxy-coated steel exterior, built-in blower with speed control, LCD display for auto pressure controller, 4 inlet/outlet valves, neoprene gloves, and pass-through with plug. Dimensions: 62.4"W x 37.6"D x 46.4"H. Select models are ETL, UL, CAN/CSA or CE marked. Model show: 3644-15.

Applications: Filter-nanoparticle manipulation, toxic powder weighing, pharmaceutical research and biochemistry; controlled atmosphere-organometallic chemistry, lithium battery handling, hemoglobin research.

| Type | Material | Cat. # | \$/Each |
|-------------------------------|---------------------|-----------------|------------------|
| Single Models (2 glove ports) | 304 Stainless Steel | 3644-16* | 32,415.00 |
| | Fiberglass | 3644-15* | 28,368.00 |
| Twin Model (4 glove ports) | 304 Stainless Steel | 3644-17* | 53,625.00 |

* 120 VAC, 60 Hz Models; 220V models also available

GLOVEBOXES: PHARMACY ISOLATORS and CONTAINMENT CHAMBERS by Germfree

A. LFGI Laminar Flow Glovebox/Isolator

With positive and negative configuration options, the LFGI Series provides ultimate product and operator protection. The ergonomic glove system and the HEPA filters provide the highest level of protection from microbiological particulates, dust, powders and aerosols. Units function as a CACI and CAI.

Available in three sizes. Models meet or exceed ISO 14644-1 for Class 5 air quality.

| Work Area Width | Cat. # | S/Each |
|-----------------|---------|-----------|
| 34.5" | 5607-15 | 19,945.00 |
| 46.5" | 5607-16 | 21,241.00 |
| 70.5" | 5607-17 | 26,342.00 |

B. VersaFlow Laminar Flow Compounding Aseptic Isolator

Constructed of high quality, all-welded stainless steel with pharmaceutical grade finish, this Compounding Aseptic Isolator (CAI) meets USP 797 regulations. The work area is bathed with unidirectional HEPA-filtered air with minimal turbulence for a sterile work environment. Units meet or exceed ISO 14644-1 Class 5 air quality and are designed to fit through standard door and elevator openings.

Available in 33", 49" and 55" work area dimensions with a fully adjustable shelf and a stainless steel stand with locking cleanroom grade casters.

System starts at \$13,070.00

C. Radiopharmacy Isolator

Choose the LFGI Series Radiopharmacy Isolator for advanced user and product protection when compounding sterile radiopharmaceuticals. Units achieve USP 797 compliance without the need for costly pharmacy ventilation renovations. ISO 14644-1 Class 5 (Class 100) air quality is maintained under dynamic conditions with unidirectional laminar airflow system. Includes 1/4" lead shielding.

Overall dimensions are 36"W x 34"D x 79.5"H. CACI units are constructed from 100% stainless steel interior and exterior with a pharmaceutical grade #4 finish. Units are designed to fit through standard door openings and elevators.

Systems start at \$45,533.00

D. SEA-III BSC

An ergonomically designed standard sized cabinet ideal for modern microbiology labs tasked with handling a wider range of hazardous biological materials. Features HEPA filtered air and double HEPA filtered exhaust air. Boosts preparedness of lab when working with emergency response networks for containing higher risk biological agents. Cost-effective stainless steel models with ergonomic design promotes natural arm position, extends reach and reduces fatigue. Exhaust system requirements: 50 cfm @ 2" H₂O (8.5 M3/hr. @ 500 Pa).



Safe, affordable, and ergonomic. Ideal for integrating Class III BSC into complex lab environments

| SEA-III Glove Boxes | | | | | |
|---------------------|----------------------------|---|---------|-----------|--|
| Glove Model | Interior Dims W" x D" x H" | Overall Dims. with 36" stand W" x D" x H" | Cat # | S/Each | |
| 2 | 41.25 x 22 x 29.25 | 60.25 x 24.75 x 76.375 | 5607-25 | 51,638.00 | |
| 3 | 54 x 22 x 29.25 | 72.25 x 24.75 x 76.375 | 5607-26 | 58,650.00 | |
| 4 | 78.125 x 22 x 29.25 | 95.125 x 24.75 x 76.375 | 5607-27 | 70,088.00 | |

VACUUM DESICCATORS

See specifications/ordering chart below.

A. High-Capacity Chamber (see chart below)

Ideal for degassing large assemblies. Powder-coated steel chamber with 1"-thick aluminum door. Includes 1"-thick polycarbonate viewing window, piping, fittings and solenoid valve for convenient control (order pump and vacuum controller separately). 18"W x 48"L stainless steel shelf creates a convenient platform 4.5" above chamber floor.

Powder-Coated Steel Stand Cat. # S/Each
 Raises chamber shelf to 34.6" above floor level **3404-04 1,248.00**

B. Stainless Steel Chamber (see chart below)

Double-wall construction; includes 8" x 8" tempered glass viewing window and dual metering valves and 0-30" vacuum gauge.

C. Aluminum Vacuum Chamber (see chart below)

One-inch-thick aluminum walls support sustained full vacuum without warping. Includes acrylic viewing window, dual metering valves and vacuum gauge. Many standard sizes! Model shown: 5235-34.

D. Full-View Acrylic Chamber (see chart below)

Made of 1/2"-thick cylindrical acrylic. Designed for continuous pump operation with safety relief valve.

E. – J. Acrylic Chambers

See chart below.

Ideal for degassing and transporting small parts. Designed for continuous pump operation (order below).

Vacuum Chamber Accessories

Metering Valves (installed) Cat. # S/Each
5235-09 168.00

Two required for direct connection to pump, or one if connecting Vacuum Controller.

Vacuum Gauge (installed) Cat. # S/Each
5235-10 206.00
 Required if selected pump does not include metering kit.

Vacuum Controller

Recommended for all continuous vacuum applications. For Full Vacuum (to 29.9" Hg). Select appropriate Turnkey Connection Kit below.

120VAC, 60Hz Cat. # S/Each
1681-75 2,878.00
 220VAC, 50Hz **1681-75-220 2,878.00**

Connection Kit

Includes all connections, vacuum, solenoid, turnkey installation and testing charges.

For Type A–C Chambers Cat. # S/Each
5400-25 1,600.00
 For Type D–J Chambers **5400-24 1,600.00**



Shown with optional stand, vacuum pump and controller



Complete line of pumps at TerraUniversal.com

| Vacuum Chambers | | | | Factory Tested* | | | | |
|-----------------|--|-------------------|-------------|-----------------|------------------|-------------|----------------|-----------------|
| Type | Dimensions (W" x D" x H" excluding hardware) | | Max. Vacuum | Cat. # | S/Each | Max. Vacuum | Cat. # | S/Each |
| | Outside | Inside | | | | | | |
| A | 49L x 30 dia. | 48L x 26 dia. | 29.9" Hg | 3404-03 | 24,178.00 | — | — | — |
| B | 13 x 15 x 14 | 8 x 12 x 8 | 29.9" Hg | 3404-00 | 3,476.00 | — | — | — |
| C | 17 X 17 X 13.5 | 15 X 15 X 11.5 | 29.5" Hg | 5235-34 | 5,968.00 | — | — | — |
| D | 12"-dia. x 14.5 | 11"-dia. x 13.5 | 29.8" Hg | 5235-08 | 2,462.00 | — | — | — |
| E | 17 x 11 x 12.5 | 14 x 8 x 9.5 | 27.0" Hg | 5235-00A | 2,309.00 | 29.9" Hg | 5235-16 | 3,359.00 |
| F | 13 x 13 x 7.5 | 10.5 x 10.5 x 4.5 | 27.0" Hg | 5235-01A | 1,738.00 | 29.9" Hg | 5235-17 | 2,788.00 |
| G | 9 x 9 x 9.5 | 6 x 6 x 6.5 | 27.0" Hg | 5235-02A | 1,508.00 | 29.9" Hg | 5235-18 | 2,558.00 |
| H | 13 x 13 x 10.5 | 10 x 10 x 7.5 | 27.0" Hg | 5235-03A | 2,025.00 | 29.9" Hg | 5235-19 | 3,075.00 |
| I | 17 x 17 x 13.5 | 15 x 15 x 11.5 | 27.0" Hg | 5235-04A | 2,387.00 | 29.9" Hg | 5235-20 | 3,437.00 |
| J | 26.5 x 11 x 12.5 | 11 x 8 x 9.5 | 27.0" Hg | 5235-06A | 2,612.00 | 29.9" Hg | 5235-21 | 3,662.00 |

* These models are individually factory leak tested and guaranteed to hold specified vacuum level for a minimum of 96 hours.

PCR WORKSTATIONS by Terra Universal



PCR Workstation (No. 1692-90) on a polypropylene table (order separately)

Terra manufactures turnkey laminar flow Polymerase Chain Reaction (PCR) Hoods with laminar flow HEPA filtering for cleanliness. The air-velocity meter monitors air flow. These lightweight models are made with acrylic or static-dissipative PVC panels. Models are available with a stainless steel work surface.

- Portable, economical turnkey hood converts any benchtop surface into a controlled PCR work station
- Safe UVC Disinfection Module with "exposure switch" to protect users from harmful UV light
- Fully-enclosed environment keeps UV energy safely contained during sterilization
- Samples and equipment introduced via large front sash
- Full-length front access shield enhances laminar flow when closed and gives users complete access to samples and equipment when open. It is held open, or safely closed during UV decontamination, with magnetic latches

| PCR Workstations | | | |
|------------------------|-------------------------|----------------|-----------------|
| PCR Hood Material | Dimensions W" x D" x H" | Cat. # | \$/Each |
| Acrylic | 36 x 24 x 30.25 | 1692-90 | 3,909.00 |
| Acrylic | 48 x 24 x 30.25 | 1692-91 | 4,185.00 |
| Static-dissipative PVC | 36 x 24 x 30.25 | 1692-93 | 4,689.00 |
| Static-dissipative PVC | 48 x 24 x 30.25 | 1692-94 | 5,018.00 |
| Tempered Glass | 36 x 24 x 30.25 | 1692-95 | 3,576.00 |
| Tempered Glass | 48 x 24 x 30.25 | 1692-96 | 3,827.00 |



Pipette Shelf

| Material | Cat. # | \$/Each |
|---------------|----------------|---------------|
| Acrylic | 1692-99 | 170.00 |
| Polypropylene | 1692-98 | 170.00 |



mLINE® Pipette Multipacks by Sartorius

| Multipacks | Cat. # | \$/Each |
|-------------------|----------------|-----------------|
| Pipette 3-pack 10 | PP03-20 | 792.00 |
| Pipette 3-pack 20 | PP03-21 | 792.00 |
| Pipette 4-pack | PP03-22 | 995.00 |
| Pipette 3+1 pack | PP03-23 | 1,314.00 |
| Pipette 5-pack | PP03-24 | 1,232.00 |



Ultra-Violet C Sanitizing Lamp

99+% kill rate for common bacteria and viruses within 2 minutes!

| Length | Cat. # | \$/Each |
|--------|----------------|---------------|
| 21" | 3305-90 | 426.00 |
| 33" | 3305-91 | 471.00 |
| 61" | 3305-92 | 594.00 |

THERMAL CYCLER by Benchmark Scientific



TC9639 Thermal Cycler

Ideal for medium- to high-throughput laboratories, the **TC9639** Thermal Cycler makes it quick and easy for users to set up programs and protocols. The large, **full-color touch screen** allows the creation of icons for most-used programs. The **program wizard** guides users through protocol set-up in a single screen and allows for program edits and alphanumeric naming of programs and folders. Condensation and evaporation of samples are prevented by the **fully adjustable heated lid**. Units also feature programmable lid temperature and the lid automatically shuts off when the block temperature is below 35°C. A proprietary algorithm with tight tolerances accurately controls heating and cooling of the block. The **multi-format block** of the TC9639 eliminates the expense and need for multiple interchangeable blocks and the model accepts 96 x 0.29 ml tubes, a 96-well plate or 39 x 0.5 ml tubes. For high-throughput labs, the **T5000-384** with 384-well block is available.

| | Cat. # | \$/Each |
|-------------------|----------------|-----------------|
| TC9639 US plug | BR19-43 | 3,850.00 |
| TC9639 EU plug | BR19-44 | 3,850.00 |
| T5000-384 US plug | BR19-46 | 4,250.00 |
| T5000-384 EU plug | BR19-47 | 4,250.00 |

Provides consistent and reliable results with unlimited program storage capability

OVENS



Heratherm General Protocol Ovens by Thermo Scientific

Ideal for routine heating and drying up to 250 °C, these energy efficient units come in benchtop or large capacity models. Gravity convection units provide low turbulence heating and drying. Mechanical Convection models provide fast drying of glassware, powders, paper and textile. Select models are CE or cCSAus listed. 120V models listed

| Model/Volume (L) | Cat. # | S/Each |
|--------------------------|----------------|-----------------|
| Gravity / 2.3 cu. ft. | 3700-87 | 1,612.00 |
| Mechanical / 2.3 cu. ft. | 3700-90 | 1,880.00 |



"Squaroid" Vacuum Ovens by Thermo Scientific

These ovens provide a max. temperature of 220°C. Radiant warm-wall heating provides more even chamber temperature, and built-in high-limit thermostat guards against overheating. Models below feature LED temperature readouts and operate at 120VAC; 240VAC and dial thermometer models are also available, as well as high-temperature models.

| Chamber Volume | Cat. # | S/Each |
|----------------|----------------|-----------------|
| 0.7 cu. ft. | 3700-80 | 2,935.00 |
| 2.3 cu. ft. | 3700-82 | 4,931.00 |



Large-Capacity Forced-Air Ovens by Sheldon Manufacturing

These versatile multi-purpose ovens create true one-pass circulation pattern for optimal uniformity and fast recovery time. Includes an electronic digital timer with large LED display and overtemperature protection and isolated heating elements. Chamber interior is stainless steel. Models shown are 120VAC.

| Chamber Size | Cat. # | S/Each |
|--------------|----------------|-----------------|
| 14.0 cu. ft. | 3700-85 | 3,582.00 |
| 28.0 cu. ft. | 3700-86 | 4,810.00 |

INCUBATORS



myTemp™ Mini Digital Incubators by Benchmark Scientific

Compact with a lot of power, the myTemp packs 20 liters of capacity in Heat Only or Heat and Cool models that accommodate bottles and flasks up to 2L. Other features include a vibrant LED control panel, a carrying handle and two adjustable shelves.

| | Cat. # | S/Each |
|-----------------------|----------------|---------------|
| myTemp H Heat Only | BR18-00 | 375.00 |
| myTemp HC Heat & Cool | BR18-01 | 580.00 |



Midi 40 Small Capacity CO₂ Incubators by Thermo Scientific

Designed specifically for cell culture scientists working within a limited space, the Midi 40 CO₂ Incubator delivers what bigger incubators do at a cost-effective price point. These compact units store up to 35 T75 culture flasks and they feature a comprehensive alarm system. Features: benchtop, stainless steel chamber and cabinet, and 1.4 cu. ft. capacity includes four stainless steel drawers.

| | Cat. # | S/Each |
|-----------------|----------------|-----------------|
| 120 V 60 HZ | 3615-78 | 4,498.00 |
| 1230 V 50/60 HZ | 3615-79 | 4,569.00 |



HERAcell® 150i & 240i CO₂ Incubators by Thermo Scientific

Available with thermo conductivity (TCD) or infrared (IR) CO₂ sensors, units provide the ideal in vitro environment for optimum cell growth. Stackable models, have excellent parameter recovery rates, a smooth and rounded inner casing and a water level sensor alarm. Units can be decontaminated without disassembly.

- 100% solid copper or stainless steel inner chamber

| | Cat. # | S/Each |
|-------------------------|----------------|------------------|
| 150L Dual, Copper TCD | 3615-40 | 16,067.00 |
| 150L Single, Copper IR | 3615-44 | 8,912.00 |
| 150L Dual, SS TCD | 3615-48 | 12,892.00 |
| 240L Single, Copper TCD | 3615-45 | 12,085.00 |
| 240L Single, Copper IR | 3615-47 | 13,217.00 |
| 240L Single, SS TCD | 3615-51 | 10,759.00 |

Freeze and Thaw Environmental Chambers

Models provide accurate control of a wide range of thermal conditions. The automatic programmable cycling between setpoints enables continuous environmental simulation for rapid testing. The controller performs 4 programs, 40 steps, an infinite number of loops and a ramp based on any time or rate.

- Material: Cold Rolled Steel, Powder Coated (Exterior); Type 304, 2B Finish, Solid Stainless Steel (Interior)
- Temperature Range: -25°C to 70°C
- Temperature Control/Uniformity at 20°C: ±0.1°C/±0.3°C
- Humidity Range/Control: 20 to 98%/±3% RH
- Application: Pharma drug research, concrete and asphalt testing, coating and adhesive testing, outdoor weathering tests, stress testing

| Model | Shelves Included/Max. | Capacity cu. ft. | 208/230 V, 60 hz | |
|-------------|-----------------------|------------------|------------------|-----------|
| | | | Cat. # | \$/Each |
| Humidified* | 4/25 | 25 | 5757-32 | 19,528.00 |
| Standard | 4/25 | 25 | 5757-33 | 16,279.00 |
| Humidified* | 5/31 | 33 | 5757-34 | 21,965.00 |
| Standard | 5/31 | 33 | 5757-35 | 17,905.00 |

* Humidified models feature gVapor energy efficient delivery of controlled humidity vapor (as needed)



Insect Growth Chambers

Designed for insect rearing in various fields and disciplines, these energy efficient units come standard with corrosion-resistant phenolic coated coils that protect interior components and contribute to unit longevity.

- Temperature range/control: 5°C to 70°C/ ±0.1°C
- Temperature uniformity/sensor: ±0.3°C/ 3-wire RTD
- Humidity range/control: 20% to 98%/ ±2% RH
- gVapor™ delivers controlled humidity vapor as needed
- gROD™ for energy savings; high R, CFC-free foam insulation
- gLux™ Fluorescent Lighting System simulates day/night conditions
- Includes adjustable, perforated stainless steel shelves
- Application: Insect growth studies in various fields and disciplines

| Model | Shelves Included/Max | Capacity cu. ft. | 115 V, 60 hz | |
|---------------|----------------------|------------------|--------------|-----------|
| | | | Cat. # | \$/Each |
| Benchtop* | 3/15 | 10 | 5757-26 | 13,602.00 |
| Floor Model** | 4/25 | 25 | 5757-27 | 15,422.00 |
| Floor Model** | 5/31 | 33 | 5757-28 | 17,172.00 |

*1 access port **2 access ports



Photostability Chambers

Specifically designed for operation near UV- and visual-light testing with fluorescent lamps, these benchtop units provide uniform light distribution and high-intensity levels for quick response to forced degradation and confirmatory processes.

- Dimensions: 37.6"W x 30.2"D x 46"H, with leveling feet.
- Shelf area dimensions: 19 x 23/Shelf capacity: 22 lbs. max
- Capacity: 10.5 cu. ft.; Lamp type: UVA and VIS
- Material: Stainless Steel/Reflective specular aluminum
- Features manual and automatic mode, programmable alarms
- Includes two access ports; two sliding shelves
- Application: Forced degradation studies and confirmatory studies in agriculture, pharmaceutical and biological industries

| Model | Time Req. to reach ICH 200 Rec.: W-hr/m2 Rec.: 1.2 million lux-hr | 115V, 60hz | |
|-------------|--|------------|-----------|
| | | Cat. # | \$/Each |
| Standard | 10 hrs. | 5757-42 | 27,497.00 |
| | 60 hrs. | | |
| Humidified* | 8 hrs. | 5757-43 | 29,247.00 |
| | 35 hrs. | | |

* Isolates effects of hydration during photostability testing





No. 2001-65

VALULINE™ LAMINAR FLOW WORKSTATIONS

A low-cost solution for laminar flow applications —

- HEPA filtration, with backpressure gauge to monitor filter operation
- Tilt-up dissipative PVC sash
- Stainless steel work station

BUY ONLINE! Items priced in blue usually ship in 1–3 days.

This economical free-standing workstation provides a particle-free environment for contamination-sensitive work. Select powder-coated or stainless steel construction. Dissipative PVC side panels help maintain a laminar flow of HEPA filtered air, and the tilt-up dissipative PVC sash allows transfer of bulky process equipment.

All models include HEPA fan/filter module(s), tilt-up sash, a stainless steel work surface and a GFI duplex power outlet. Dimensions: 32"D x 89"H (see chart below for width). Top module with filter/fan can be removed for transfer through standard door.

| Valuline Laminar Flow Station | | | | | | | |
|-------------------------------|---------------------|--------------------|-----------------|---------------------|--------------------|-----------------|--------|
| Width (Inches) | 304 Stainless Steel | | | Powder Coated Steel | | | |
| | 20VAC, 50/60Hz | 220VAC, 50Hz | S/Each | 20VAC, 50/60Hz | 220VAC, 50Hz | S/Each | S/Each |
| 52 | 2001-65 | 2001-65-220 | 6,947.00 | 2001-68 | 2001-68-220 | 5,183.00 | |
| 76 | 2001-66 | 2001-66-220 | 7,798.00 | 2001-69 | 2001-69-220 | 5,809.00 | |
| 100 | 2001-67 | 2001-67-220 | 8,936.00 | 2001-70 | 2001-70-220 | 6,703.00 | |



No. 1870-02 with optional filter/fan unit, light, panel kit and table.

CLEANBOOTH™ LAMINAR FLOW STATION

The backbone of this system is one or more filter/fan units (FFUs), each with industry-leading low-noise impeller blowers. Flexible side curtains create a 3-sided enclosure, enhancing the laminar flow. See other options below.

Mobile Frame Support

Includes set of 4 casters, 2 with locking brakes. Order FFUs below.

| Overall Dimensions (W x D, nominal) | No. of FFUs (order below) | Standard Height: 82" | Cat. # | S/Each |
|-------------------------------------|---------------------------|----------------------|----------------|-----------------|
| 49" x 25" | (1) 24" x 48" | | 1870-01 | 1,230.00 |
| 73" x 25" | (2) 24" x 36" | | 1870-02 | 1,460.00 |

*Filter face 70" above floor

Filter/Fan Units

Includes HEPA filter rated 99.99% efficient @ 0.3 μm particles. All models are 120VAC, 220V models available.

| Nominal Dim. width x length | Power | Avg. Flow @ 90 FPM | HEPA FFU | | Ionizing Bar with FFU Connection Kit* | |
|-----------------------------|--------|--------------------|------------------|---------------|---------------------------------------|---------------|
| | | | Cat. # | S/Each | Cat. # | S/Each |
| 2' x 4' | 110VAC | 644 CFM | 6601-24-H | 777.00 | 2005-49 | 851.00 |
| 2' x 3' | 110VAC | 477 CFM | 6601-23-H | 777.00 | 2005-48 | 744.00 |

* Order FFU separately.

Softwall Panel Kits

40-mil curtains are 60" long. Each kit includes 2'-wide side panels and appropriate length to cover the rear of the station.

| For CleanBooth | Cleanroom Vinyl | | Anti-Static Vinyl | |
|----------------|-----------------|---------------|-------------------|---------------|
| | Cat. # | S/Each | Cat. # | S/Each |
| 49" width | 1330-00A | 293.00 | 1330-01A | 370.00 |
| 73" width | 1330-05A | 570.00 | 1330-06A | 721.00 |

Fluorescent Light

| | 115/277VAC, 50/60Hz | | |
|------------|---------------------|---------------|---------------------------|
| Cat. # | S/Each | | |
| 35.5" long | 1870-10 | 249.00 | (order two for 73" booth) |
| 47" long | 1870-11 | 306.00 | (order one for 49" booth) |

BENCHTOP LAMINAR FLOW HOODS

Terra offers several bench-top systems to meet a variety of application requirements. Visit TerraUniversal.com for complete operating specifications and pricing on dozens of standard configurations.

A. ValuLine™ Dust-Free Hoods

Provides an economical, HEPA-filtered enclosure for a host of contamination-sensitive applications, including sample testing, weighing and packaging. Models are available in four sizes and six materials: acrylic, polypropylene, static-dissipative and non-dissipative PVC, stainless steel and tempered glass. Model shown: No. 1715-09B hood with 6601-1636-H HEPA fan-filter unit (total price: **\$1,692**).

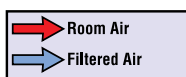
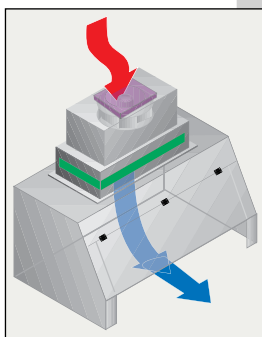

A No. 1715-09B

B. CleanCube™ Seamless Laminar Flow Hood

Terra's CleanCube™ provides a vertical laminar flow of filtered air to create a particle-free environment. Its one-piece hood design eliminates cracks and crevasses where germs or particles can collect. The covered corners are easy to wipe down, and the absence of corner support members ensures a full view of work in progress. It also eliminates the cramped, claustrophobic feeling that operators experience when working with a hood. Fan/Filter Unit (FFU) provides 310 CFM average flow of HEPA-filtered air at 260 ft./minute. Includes swing-up access shield.

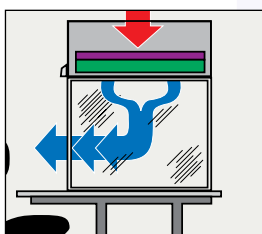

Rounded corners for easy cleaning, full visibility



B No. 2003-10A

C. WhisperFlow™ Bench-top Hood

This versatile system offers industry-leading low noise and vibration (48 dBA) in either a horizontal or vertical flow configuration. It consists of two modules: a fan/filter unit (FFU), which houses a HEPA or ULPA particle filter, and a hood. Models are available in 36" and 48" widths.

Benchtop Hoods 48"W (36"W models available)

| Hood Material* | Cat. # | S/Each |
|-----------------------------------|-----------------|-----------------|
| Vertical Flow | | |
| Acrylic | 1686-50C | 2,719.00 |
| Static Dissipative PVC | 1686-51C | 3,551.00 |
| Nondissipative PVC | 1686-52C | 2,719.00 |
| Stainless Steel (Dissipative PVC) | 1686-54C | 3,565.00 |
| Horizontal Flow | | |
| Acrylic | 1686-55C | 2,719.00 |
| Static Dissipative PVC | 1686-56C | 3,551.00 |
| Nondissipative PVC | 1686-57C | 2,719.00 |
| Stainless Steel (Dissipative PVC) | 1686-59C | 3,565.00 |

* Unless indicated in parentheses, shield is made of the same material as the hood.

Fan/Filter Module Cat. # **6601-24-H** S/Each **777.00**
24" x 48", with 99.99% efficient HEPA filter (rated @ 0.3 µm particles)



Horizontal or vertical configurations

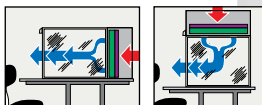

BUY ONLINE! Items priced in blue usually ship in 1-3 days.



C No. 1686-50C

Other models available at TerraUniversal.com

- 34" depths
- All-polypropylene models
- 2', 3' and 6' widths
- Spill trays



Model shown: No. 9620-64
For complete specifications: TerraUniversal.com

HORIZONTAL LAMINAR FLOW STATION

Terra's Horizontal Laminar Flow Station provides an economical work environment that exceeds the most stringent contamination requirements in the pharmaceuticals, biotech, electronics and semiconductor industries.

Powerful filter/blower modules provide a back-to-front laminar flow of filtered air across the work surface. The adjustable multi-speed, direct-drive blowers let you adjust air speed (90 – 130 feet per minute) to meet your requirements while providing low noise and vibration levels.

For enhanced air-stream control, this station also features return ducts along the front and side edges of the work area. These ducts enhance system efficiency by reducing backwash, the most common source of turbulence in a laminar flow system. Includes recessed illuminator; UV-C sterilization lamps available.

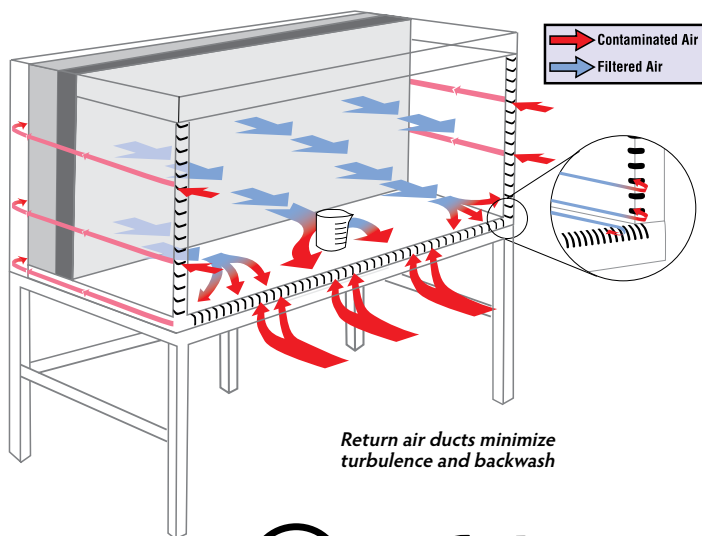

Return air ducts minimize turbulence and backwash



| Petcocks | Cat. # | S/Each |
|------------------------------|---------|--------|
| Nitrogen/Clean Dry Air (CDA) | 9620-07 | 93.00 |
| Vacuum | 9620-08 | 93.00 |
| DI Water | 9620-09 | 93.00 |

| Horizontal Laminar Flow Station (order filters separately) | | | | | | | Filters | |
|--|--------------------------------------|---------------------------------------|--|-----------|--------------------|-----------|--------------------------|------------------|
| Overall Dimensions* (W" x D" x H") | Work Area Dimensions* (W" x D" x H") | No. of FFUs required (order at right) | Horizontal Laminar Flow: Interior Material** | | | | HEPA Filter/Fan Units*** | |
| | | | 304 Stainless Steel | | Electropolished SS | | Size (W x L) | |
| | | | Cat. # | S/Each | Cat. # | S/Each | Cat. # | S/Each |
| 52 x 44 x 63 | 48 x 30 x 28 | (1) 2' x 4' | 9620-63 | 9,858.00 | 9620-66 | 12,050.00 | 2' x 4' | 6601-24-H 777.00 |
| 76 x 44 x 63 | 72 x 30 x 28 | (2) 2' x 3' | 9620-64 | 11,841.00 | 9620-67 | 13,567.00 | 2' x 3' | 6601-23-H 777.00 |
| 88 x 44 x 63 | 84 x 30 x 28 | (1) 2' x 4' & (1) 2' x 3' | 9620-65 | 12,263.00 | 9620-68 | 14,574.00 | | |

Note: All models are 115VAC, 50/60Hz. For 220VAC, 50Hz, add "-220" to the part number.

* All dimensions are nominal.

** Work top and side panels are of the material indicated. All exterior surfaces are powder-coated CR steel.

*** 99.99% efficient @ 0.3 micron particles. ULPA filters also available.

VERTICAL LAMINAR FLOW STATION

This economical system provides a laminar flow of HEPA-filtered air to meet the most critical contamination requirements. It incorporates industry-leading 48 dBA blowers for quiet, low-vibration operation. The all-304 stainless steel or powder-coated steel is cleanroom compatible and easy to clean and sterilize. An optional motorized front shield extends 3" – 25" above the work area for more effective particle control. Fluorescent lighting is included; for complete line of options, visit TerraUniversal.com



Strip shield access curtain (option)

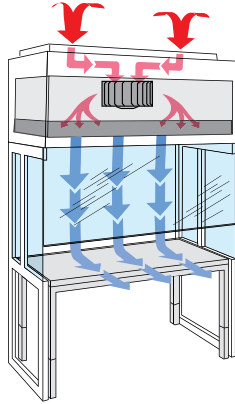

Shown with optional sliding shield and drawer unit



*System option

Filter/Fan Units (FFUs) 115VAC, 60Hz* See chart below for quantity required

| Nominal Dim. width x length | Avg. Flow @ 90 FPM | HEPA FFU | | Ionizing Bar** | |
|--------------------------------|-----------------------|-----------|--------|----------------|--------|
| | | Cat. # | S/Each | Cat. # | S/Each |
| 2' x 4' | 650 CFM | 6601-24-H | 777.00 | 2005-49 | 851.00 |
| 2' x 3' | 480 CFM | 6601-23-H | 777.00 | 2005-48 | 744.00 |
| 2' x 2' | 360 CFM | 6601-22-H | 777.00 | 2005-47 | 621.00 |

* ULPA versions also available. For 220VAC model, add "-220" to the part number.
** See TerraUniversal.com for specifications. Includes installation kit.

| Vertical Laminar Flow Station | | | | | | | | | | Side Panel* | | Sliding Shield | |
|-------------------------------|----|---------|--|---|--------------|--------------|---|--------------|--------------|------------------------|--------|------------------------|----------|
| Dimensions (inches) | | | No. of FFUs required (order above) | 304 Stainless Steel (Order FFUs and Benches separately) | | | Powder Coated Steel (Order FFUs and Benches separately) | | | Static Dissipative PVC | | Static Dissipative PVC | |
| | | | | 120VAC, 50/60Hz | | 220VAC, 50Hz | 120VAC, 50/60Hz | | 220VAC, 50Hz | | | | |
| A | B | W x D | | Cat. # | Cat. # | S/Each | Cat. # | Cat. # | S/Each | Cat. # | S/Each | Cat. # | S/Each |
| 52 | 49 | 48 x 30 | (1) 2' x 4' | 2001-30A | 2001-30A-220 | 6,197.00 | 2001-80A | 2001-80A-220 | 4,403.00 | 2004-03 | 162.00 | 9207-04 | 1,712.00 |
| 76 | 73 | 72 x 30 | (2) 2' x 3' | 2001-32A | 2001-32A-220 | 7,247.00 | 2001-82A | 2001-82A-220 | 5,356.00 | 2004-03 | 162.00 | 9207-06 | 2,315.00 |
| 100 | 97 | 96 x 30 | (2) 2' x 4' | 2001-33A | 2001-33A-220 | 8,192.00 | 2001-83A | 2001-83A-220 | 6,289.00 | 2004-03 | 162.00 | 9207-07 | 2,487.00 |

* Replaces standard plexiglass side panels (each station requires two). Static-Dissipative PVC is recommended on units equipped with optional dissipative sliding shield.

| Corresponding Solid Top Work Benches* | | | | | | | | | | Perforated-Top Work Benches* | | | | |
|---------------------------------------|----|---------|-------------------------|--------|----------------|----------|-------------------|----------|-------------------|------------------------------|-------------------------|----------|--|----------|
| Dimensions (inches) | | | Nonconductive Steel Top | | Conductive Top | | 304 Stainless Top | | Polypropylene Top | | 304 Stainless Steel Top | | 304 Stainless Steel (Polypropylene Plenum) | |
| | | | Cat. # | S/Each | Cat. # | S/Each | Cat. # | S/Each | Cat. # | S/Each | Cat. # | S/Each | Cat. # | S/Each |
| 52 | 49 | 48 x 30 | 1722-00 | 690.00 | 1728-00 | 1,012.00 | 1521-45 | 1,285.00 | 1522-00 | 894.00 | 1522-56 | 1,313.00 | 1526-50 | 2,298.00 |
| 64 | 61 | 60 x 30 | 1724-00 | 767.00 | 1730-00 | 938.00 | 1751-00 | 1,236.00 | 1522-01 | 929.00 | 1522-57 | 1,404.00 | 1526-51 | 2,563.00 |
| 76 | 73 | 72 x 30 | 1726-00 | 756.00 | 1732-00 | 1,061.00 | 1752-00 | 1,290.00 | 1522-02 | 951.00 | 1522-58 | 1,589.00 | 1526-52 | 2,796.00 |
| 100 | 97 | 96 x 30 | 2402-00 | 937.00 | 2400-00 | 1,202.00 | 1753-00 | 1,452.00 | 1522-04 | 1,177.00 | 1522-60 | 1,974.00 | 1526-54 | 3,520.00 |

* Powder-coated adjustable-height frame; top of material indicated.



A No. 3646-05



B No. 3646-49

A. Basic Laboratory Hoods

These basic lab hoods are ideal for labs requiring light duty applications. The by-pass airflow maintains stable face velocity and vapor-proof or explosion-proof blower models provide safe ventilation. Various system options are available in 47" and 70" widths. Model shown: 3646-05 (70" width).

B. Fiberglass 30 Laboratory Hoods

Made with chemical resistant one-piece fiberglass interior and an epoxy-coated steel exterior, these compact by-pass models maintain stable face velocity, and the pivoting air foil maximizes containment. Select models are available with an internal exhaust blower. Model shown: 3646-49.

| A. Basic 47 Laboratory Hoods: 47"W x 25"D x 53"H | | | | | | | Work Surface† | | | |
|--|--------------|------------------------|----------|----------------------------|----------------|-----------------|--------------------|-----------------|----------------|-----------------|
| Incandescent Lamp | Blower Motor | Equivalent Resistance* | | Shipping Weight lbs./kg | 115VAC, 60Hz | | 220VAC, 50Hz*** | | | |
| | | 10" dia | 12" dia. | | Cat. # | S/Each | Cat. # | S/Each | | |
| Vapor Proof | 1/3 HP | 100' | 250' | 370/168 | 3646-00 | 4,315.00 | 3646-00-220 | 4,315.00 | 3646-02 | 1,020.00 |
| Explosion-Proof** | 1/2 HP, EP | 100' | 250' | 375/170 | 3646-01 | 5,088.00 | 3646-01-220 | 5,088.00 | 3646-02 | 1,020.00 |
| Basic 70 Laboratory Hoods: 70"W x 25"D x 53"H | | | | | | | Work Surface† | | | |
| Vapor Proof | 3/4 HP | 45' | 100' | 450/204 | 3646-05 | 5,575.00 | 3646-05-220 | 5,688.00 | 3646-07 | 1,406.00 |
| Explosion-Proof** | 3/4 HP EP | 45' | 100' | 455/206 | 3646-06 | 6,115.00 | 3646-06-220 | 6,208.00 | 3646-07 | 1,406.00 |

* Maximum length of straight duct to achieve 100FPM face velocity. ** Bulb not included on explosion-proof models.
 *** International electrical configuration. †48"/72"W x 30"D x 1.25" thick black epoxy-coated steel

| B. Fiberglass 30 Laboratory Hoods: 30"W x 30.16"D x 48"H* | | | | | | | Work Surface† | | |
|---|-------------------------|---------|----------------------------|----------------|-----------------|--------------------|-----------------|----------------|---------------|
| Blower Motor | Equivalent Resistance** | | Shipping Weight lbs./kg | 115VAC, 60Hz | | 220VAC, 50Hz*** | | Cat. # | S/Each |
| | 6" dia | 8" dia. | | Cat. # | S/Each | Cat. # | S/Each | | |
| Yes†† | 20' | 80' | 230/104 | 3646-48 | 3,933.00 | 3646-48-220 | 4,029.00 | 3646-50 | 615.00 |
| None | — | — | 210/95 | 3646-49 | 3,603.00 | 3646-49-220 | 3,712.00 | 3646-50 | 615.00 |

* Model 3646-48-220 is 54"H
 ** Maximum length of straight duct to achieve 100FPM face velocity
 *** International electrical configuration.
 † 48"/72"W x 30"D x 1.25" thick black epoxy-coated steel
 †† 1/10 HP (120V); 1/3 HP (220V)



C. Purifier® Logic+ Biosafety Cabinets

Ergonomically designed in harmony with the natural stance and movements of the human body, the Purifier Logic+ Class II, Type A2 biosafety cabinets protect users, products and environments from hazardous agents that require Biosafety Level 1, 2 or 3. The Logic+ recirculates 70% of the HEPA-filtered air into laboratory and 30% passes through an exhaust system with optional Canopy Connection.

- **Inclination™ Technology** provides comfort, safety and effortless operation for users of all sizes
- **Constant Airflow Profile (CAP) Technology** monitors and provides accurate airflow at all times without airflow sensors
- **Electronically Commutated Motor (ECM)** uses 60% less energy compared, is quiet in operation and it provides cooler working conditions.
- **MyLogic™ OS** is a large full-color display for intuitive programming and feedback
- Increased performance and productivity with new blower packages (tested, proven and optimized for each BSC)

By-pass models are NSF and ETL listed, CE listed (230V), and UL (115V and select 230V) listed. Nominal widths in: 3, 4, 5 and 6 foot options. Domestic and international electrical configurations are available.

| Size | Dimensions W" x D" x H" | Cat. # | \$/Each |
|--------------------------------|-------------------------|-----------------|------------------|
| 4' with 10" sash opening, 115V | 54.3 x 31.2 x 89.2-95.2 | 3642-00* | 9,368.00 |
| 6' with 8" sash opening, 115V | 78.3 x 31.2 x 89.2-95.2 | 3642-22* | 11,546.00 |

* UV Light, Service Fixture, Vacu-Pass Portal and Base Stand

D. Paramount® Ductless Enclosures

These self-contained workstations require no ducting to the outside, making them ideal for applications that require portability or flexible installation. An air foil enhances fume containment. Other sizes and accessories, including filters, at TerraUniversal.com. Height work area dimension: 32".

| Work Space Dimensions | 115VAC, 60Hz Cat. # | \$/Each | 230VAC, 50Hz Cat. # | \$/Each |
|-----------------------|---------------------|------------------|---------------------|------------------|
| 33.6" W x 23.4" D | 3647-06 | 6,321.00 | 3647-06-220 | 6,411.00 |
| 69.6" W x 23.4" D | 3647-07 | 10,591.00 | 3647-07-220 | 10,693.00 |

E. Protector® XStream® Laboratory Hoods

High-performance, low-volume benchtop models provide maximum containment and energy savings. The patented features significantly reduce contaminants near the user's breathing and behind the sash opening. By-pass models available in 4, 5, 6 and 8 foot widths. Model shown: (5' width).

| Work Space Dimensions | Cat. # | \$/Each |
|-----------------------|----------------|-----------------|
| 60.0" W x 37.7" D | 1538-34 | 6,949.00 |

F. Protector® Premier® Laboratory Hoods

As the only high performance hood in the market available with a built-in blower, these benchtop models have containment enhancing features and their dimensions match standard lab casework, base cabinets and stands. Available in 4, 5, 6 and 8 foot widths. Model shown: (4' width).

| Work Space Dimensions | Cat. # | \$/Each |
|-----------------------|----------------|-----------------|
| 48.0" W x 31.7" D | 3649-04 | 6,105.00 |

WORK BENCHES and CHAIRS



Note: Benches above are pictured with optional drawer module No. 1740-07 (3", 6" and 12" drawer height); others configurations in both plastic and stainless steel are available.

| Work Benches—select desired top (all bases feature a white powder-coated finish) | | | | | | | | D. Vibration-Free Platform | | |
|--|----------------------|---------------------------|---------|--------------------|----------|--------------------------------|----------|----------------------------|-------------------------------------|----------|
| Base Type (Epoxy Finish) | Width (Depth=30") | A. Nonconductive Laminate | | B. Stainless Steel | | C. Vibration-Free Laminate Top | | Work Surface (W"xD"xH") | Electropolished Stainless Steel Top | |
| | | Cat. # | \$/Each | Cat. # | \$/Each | Cat. # | \$/Each | Cat. # | \$/Each | |
| Telescoping "A" Base | 48 | 1722-00 | 690.00 | 1521-45 | 1,285.00 | 1570-00A | 2,098.00 | 21.75 x 18.25 x 3 | 1580-02 | 2,566.00 |
| | 60 | 1724-00 | 767.00 | 1751-00 | 1,236.00 | 1570-01A | 2,134.00 | 23 x 24 x 3 | 1580-03 | 2,766.00 |
| | 72 | 1726-00 | 756.00 | 1752-00 | 1,290.00 | 1570-02A | 2,149.00 | | | |
| Recessed "C" Base | 48 | 1521-09 | 637.00 | 1521-54 | 1,057.00 | — | — | | | |
| | 60 | 1000-00 | 709.00 | 1521-55 | 1,315.00 | — | — | | | |
| | 72 | 1000-01 | 697.00 | 1521-56 | 1,182.00 | — | — | | | |

Visit TerraUniversal.com for other bench styles:

- ErgoHeight™ Adjustable Height Tables
- Acid-resistant polypropylene tops
- Dozens of standard sizes



E. – I. Class 100 & Static Control

Clean vinyl meets Class 100 (ISO 5) particle requirements. Static-Control chairs feature dissipative vinyl, conductive casters, and grounding chains.

| Specs | | Class 100 Static Control | | | | | | Class 100 | | | | |
|--------|-------|--------------------------|---------|----------|---------|----------|---------|-----------|---------|-------|----------|---------|
| Height | Color | E. | | F. | | G. | | H. | | Color | I. | |
| | | Cat. # | \$/Each | Cat. # | \$/Each | Cat. # | \$/Each | Cat. # | \$/Each | | Cat. # | \$/Each |
| Desk | Black | 2802-61* | 427.00 | 2802-67* | 433.00 | 2802-73* | 441.00 | 1012-05* | 489.00 | Black | 1012-11 | 495.00 |
| | Blue | 2802-62* | 427.00 | 2802-68* | 433.00 | 2802-74* | 441.00 | — | — | Black | 1013-51* | 568.00 |
| Bench | Black | 2802-64* | 433.00 | 2802-70* | 436.00 | 2802-76* | 448.00 | 1012-41 | 450.00 | Black | 1012-12 | 495.00 |
| | Blue | 2802-65* | 433.00 | 2802-71* | 436.00 | 2802-77* | 448.00 | 1013-12 | 529.00 | Black | 1013-52* | 568.00 |

* Quick ship models—usually ship within one week!

WORK BENCHES and CHAIRS



QuietTop Rod-Top Benches

Compare!
Rods anchored by non-outgassing elastomer that eliminates welds, dampens noise and vibrations.



Competitor's design

Hidden reinforcements minimize dead spots, add strength, and eliminate deflection bounce-back, no matter how large the benchtop.



Open-Top Perf-Top Benches

Heavy-Duty All-Electropolished Stainless Steel Work Stations (800-lb. load capacity)

QuietTop™ Rods with Full Bullnose
ø ¼" rods on 1" centers

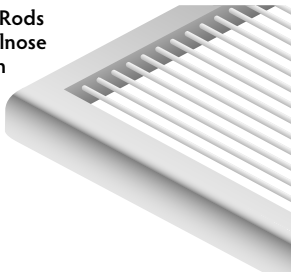

OpenTop™ Perforated with ErgoEdge™ Rounded Front
ø ¼" holes

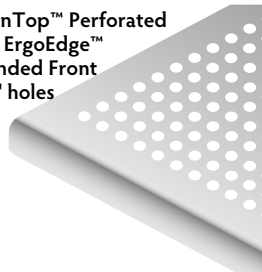

OpenTop Perforated with ErgoEdge Rounded Front
ø ¼" holes

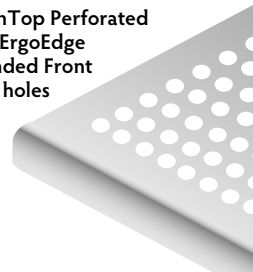

Solid Top with ErgoEdge Rounded Front

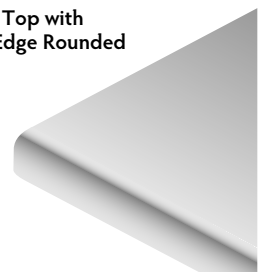

| Bench Size * (W" x D") | "A" Base | | | "C" Base | | | "A" Base | | | "C" Base | | | "A" Base | | | "C" Base | | |
|---------------------------|----------|---------|----------|----------|---------|----------|----------|---------|----------|----------|---------|----------|----------|--------|--------|----------|--------|--------|
| | Cat. # | Cat. # | S/Each | Cat. # | Cat. # | S/Each | Cat. # | Cat. # | S/Each | Cat. # | Cat. # | S/Each | Cat. # | Cat. # | S/Each | Cat. # | Cat. # | S/Each |
| 36 x 30 | 9601-17 | 9601-18 | 1,685.00 | 9604-59 | 9604-80 | 1,636.00 | 9601-59 | 9601-60 | 1,494.00 | 9603-01 | 9603-02 | 1,314.00 | | | | | | |
| 48 x 30 | 9601-19 | 9601-20 | 1,895.00 | 9604-60 | 9604-81 | 3,127.00 | 9601-61 | 9601-62 | 2,085.00 | 9603-03 | 9603-04 | 1,512.00 | | | | | | |
| 60 x 30 | 9601-21 | 9601-22 | 2,124.00 | 9604-61 | 9604-82 | 2,347.00 | 9601-63 | 9601-64 | 2,111.00 | 9603-05 | 9603-06 | 1,637.00 | | | | | | |
| 72 x 30 | 9601-23 | 9601-24 | 2,484.00 | 9604-62 | 9604-83 | 2,625.00 | 9601-65 | 9601-66 | 2,205.00 | 9603-07 | 9603-08 | 1,830.00 | | | | | | |
| 84 x 30 | 9601-25 | 9601-26 | 2,648.00 | 9604-63 | 9604-84 | 2,746.00 | 9601-67 | 9601-68 | 2,342.00 | 9603-09 | 9603-10 | 2,038.00 | | | | | | |
| 96 x 30 | 9601-27 | 9601-28 | 3,028.00 | 9604-64 | 9604-85 | 3,249.00 | 9601-69 | 9601-70 | 2,871.00 | 9603-11 | 9603-12 | 2,346.00 | | | | | | |

* Prices for "A" base and "C" base designs are the same. Standard height is 30" (floor to top). Heights of 32" and 36" and widths of 34" are available at no extra charge. Specify when ordering.



Ergonomic Upholstered #2801-05



Ergonomic Upholstered #2801-33



Ergonomic Upholstered #2801-66



Urethane #1013-16



Ergonomic ESD #1012-24

J - N. Laboratory Chairs

Select from our large assortment of Laboratory Chairs. Types J-L are upholstered chairs built with ergonomic benefits. Types M and N meet durability and budget needs.

| Height | Color | Ergonomic Upholstered Chairs* | | | | | | Color | Urethane Chairs** | | ESD Chair | |
|--------|-------|-------------------------------|--------|-------------|--------|-------------------|--------|--------|-------------------|--------|-----------|--------|
| | | J. w/Seat Control | | K. Standard | | L. Large Backrest | | | M. | | N. | |
| Desk | | Cat. # | S/Each | Cat. # | S/Each | Cat. # | S/Each | Cat. # | S/Each | Cat. # | S/Each | |
| Desk | Black | 2801-01* | 319.00 | 2801-33* | 274.00 | 2801-65* | 289.00 | Black | 1013-16 | 273.00 | 1012-14 | 437.00 |
| | Blue | 2801-02* | 319.00 | 2801-34* | 274.00 | 2801-66* | 289.00 | | 1013-17* | 306.00 | 1012-19 | 498.00 |
| Bench | Black | 2801-05* | 362.00 | 2801-37* | 277.00 | 2801-69* | 292.00 | Black | 1013-18* | 334.00 | 1012-24 | 498.00 |
| | Blue | 2801-06* | 362.00 | 2801-38* | 277.00 | 2801-70* | 292.00 | | — | — | 1013-46 | 589.00 |

* Available in Grade 2 Vinyl or Grade 4 Breathable Nylon. Visit TerraUniversal.com for more color options.

** More configurations available on the website.

MODULAR CLEANROOMS



A



B Hardwall rooms comply with USP-797 requirements



E Valuline™ Cleanrooms—ship in 5 days



Multi-room hardwall cleanroom with polycarbonate panels

C



Hardwall cleanroom with internal-mount polypropylene panels for easy cleaning, A/C, and high speed CleanSeal® Roll-Up Doors

F



Hardwall Acrylic ISO 7 Cleanroom
 Reference No. 131609
 Total Square Footage: 1391
 Cost: \$159,158

D



304 stainless steel BioSafe Cleanroom

G



Versatile BioSafe® panels accommodate complex cleanroom designs, with interior production rooms and gowning areas dedicated to your workflow and cleanliness requirements

H

MODULAR CLEANROOMS

Free-standing, all-steel structures create sturdy, versatile, clean processing solutions that meet cleanliness requirements to Class 10 (ISO 4). Whatever your application, Terra delivers a pre-tested, turnkey system.

Hardwall Designs

- Acrylic or static-dissipative rigid panels for full visibility
- Steel support frame spans up to 20 feet without internal pillars or external supports
- Mirror-finished stainless steel trim creates a showcase exterior
- A/C and humidity controls
- Available raised floors optimize laminar airflow

Models shown:

- A. Static-dissipative PVC ISO 5 cleanroom interior: includes gowning antechamber with pass-through chamber and 9-foot ceilings.
- B. Polycarbonate cleanroom designed to USP-797 requirements for compounding pharmacies
- C. ISO 6 cleanroom with acrylic panels and multi-suite floorplan
- D. ISO 7 cleanroom with acrylic panels and multi-suite floorplan

Softwall Designs

- New ValuLine™ rooms—full performance at lower cost
- Portable, expandable, easy to assemble and disassemble
- Curtain panels and parting strip shields, in anti-static cleanroom-grade vinyl
- Rigid steel support frame requires no ceiling supports
- Casters available

Models shown:

- E. ValuLine Softwall Cleanroom provides value without sacrificing performance! Turnkey models start under \$10,000 and ship in 3 – 4 days. Cleanliness to ISO 5 (Class 100).

Configured to Your Specifications!

- Air conditioning
- Humidification/Dehumidification
- Rapid-Operation Doors
- Raised Floor

BioSafe® All-Steel Designs

- Perfect for ultra-clean applications requiring frequent cleaning or sterilization
- Smooth interior walls with radius corners eliminate cracks that harbor germs and particles
- 304/316 stainless or powder-coated steel panels
- Negative-pressure airflow designs available for fume venting

Models shown:

- F. Powder-coated BioSafe room with dual quick-response roll-up doors; ideal for transfer of bulky equipment or carts.
- G. Stainless steel BioSafe ISO 5 cleanroom with air shower entry and ceiling plenum.
- H. Powder-coated ISO 7 BioSafe cleanroom interior

**Convert any space into a controlled environment—
 in a fraction of the time, at a fraction of the cost!**

BIOSAFE+® PASS-THROUGH CHAMBERS

- **Flush Mount** — no cracks or surfaces to collect particles
- **Seamless** — Unique design eliminates cracks, corners and other contaminant traps!
- **Lipless** — Easy material transfer with no clearance obstruction
- **Easy to Clean** — Ultra-smooth internal surfaces
- **Easy to Sterilize** — 304/316 electropolished SS; removable doors can be steam sterilized
- **Double-Wall, Sealed Construction** — adds rigidity and houses interlock and standard or custom utilities



Other Styles at TerraUniversal.com



Roll-Up Door Pass-Through



CleanSeam+™ Pass-Through



Fire-Rated Pass-Throughs and Doors

VALULINE™ SMARTDESICCATOR™

- “Smart” relative humidity controller regulates nitrogen purge to maintain user-selected set point
- Easy two-button programming—takes seconds to install and set target relative humidity level
- Eliminates nitrogen waste by purging only when needed—cuts N₂ expenses by up to 78%
- Available in acrylic or static-dissipative PVC, which eliminates surface charges that attract particles and create electro-static discharge
- Reinforced doors and rigid cabinet construction ensure a long service life
- Chrome-plated rack allows versatile shelf positioning to accommodate various sample sizes (order plastic or electropolished stainless steel shelves separately)



Model shown is 10-chamber Acrylic, Cat. No. 3949-48A

| Specifications | | Clear Acrylic** | | Static-Dissipative PVC | |
|----------------|--------------------------------------|-----------------|----------|------------------------|----------|
| No of Chambers | Nominal Dimensions W" x D" x H" (mm) | Cat. # | S/Each | Cat. # | S/Each |
| 1 | 17.12 x 16 x 13 | 3949-41A | 1,301.00 | 3949-49A | 1,450.00 |
| 2 | 17.12 x 16 x 25 | 3949-42A | 1,603.00 | 3949-50A | 1,902.00 |
| 3 | 17.12 x 16 x 37 | 3949-43A | 2,015.00 | 3949-51A | 2,277.00 |
| 4 | 17.12 x 16 x 49 | 3949-44A | 2,132.00 | 3949-52A | 2,693.00 |
| 5 | 17.12 x 16 x 61 | 3949-45A | 2,369.00 | 3949-53A | 3,078.00 |
| 6 | 35 x 16 x 37 | 3949-46A | 3,054.00 | 3949-54A | 4,117.00 |
| 8 | 35 x 16 x 49 | 3949-47A | 3,464.00 | 3949-55A | 4,740.00 |
| 10 | 35 x 16 x 61 | 3949-48A | 4,203.00 | 3949-56A | 5,863.00 |

* Order desired shelves and stands separately (see below).

** Acrylic is damaged by repeated contact with strong cleaning agents, including alcohol



All plastic and stainless steel SmartDesiccator cabinets

RH Control Module takes seconds to program!



VALULINE™ ES DESICCATORS

Extended Storage Systems

- Reinforced doors and rigid cabinet construction
- Select economical acrylic or static-dissipative PVC for electro-static protection and enhanced particle control
- Adjustable-height acrylic or electropolished stainless steel shelves (order separately)
- Easy-clean rounded corners for particle-sensitive applications
- Flowmeter and Automatic RB® (Relief/Bleed) valve allow nitrogen purging for dry storage requirements (order separately)
- Also ideal for use with desiccant or as a general-purpose dust-free storage cabinet



No. 3949-27B (Acrylic) and No. 3949-32B (SDPVC)

| Specifications | | Clear Acrylic** | | Static-Dissipative PVC | |
|----------------|--------------------------------------|-----------------|----------|------------------------|----------|
| No of Chambers | Nominal Dimensions W" x D" x H" (mm) | Cat # | S/Each | Cat # | S/Each |
| 1 | 19.125 x 16 x 13 | 3949-25B | 301.00 | 3949-30B | 450.00 |
| 2 | 19.125 x 16 x 25.25 | 3949-26B | 603.00 | 3949-31B | 902.00 |
| 3 | 19.125 x 16 x 37.25 | 3949-27B | 1,015.00 | 3949-32B | 1,277.00 |
| 4 | 19.125 x 16 x 49.25 | 3949-28B | 1,132.00 | 3949-33B | 1,693.00 |
| 5 | 19.125 x 16 x 61.25 | 3949-29B | 1,369.00 | 3949-34B | 2,078.00 |
| 6 | 36.75 x 16 x 37.25 | 3949-35B | 2,054.00 | 3949-38B | 3,117.00 |
| 8 | 36.75 x 16 x 49.25 | 3949-36B | 2,464.00 | 3949-39B | 3,740.00 |
| 10 | 36.75 x 16 x 61.25 | 3949-37B | 3,203.00 | 3949-40B | 4,863.00 |

* Order desired shelves and stands separately (see below).

** Acrylic is damaged by repeated contact with strong cleaning agents, including alcohol



A



B



C



D



D



E



F

A. Barnstead™ MicroPure™ System

The compact units are ideal for producing ultrapure water for molecular biology, microbiology and analytical chemistry labs. They produce 15 liters/day of Type 1 water and are available with mix-and-match system option for UV, UF, UV/UF treatment.

| | Cat. # | \$/Each |
|--------------------------|----------------|-----------------|
| Analytical and UV System | 3614-91 | 3,375.00 |
| UV-ST System | 3614-96 | 3,531.00 |

(Includes integrated 6 L feed water tank)

B. B-Pure Cartridge Systems

Provides point-of-use deionization for laboratories and other facilities requiring pure water. The flexible design allows configuration to meet your water needs. Accepts most Thermo Scientific Barnstead cartridges and filters (ordering information at Laboratory-Equipment.com).

| | Cat. # | \$/Each |
|---------------|----------------|---------------|
| Single Holder | 3613-52 | 373.00 |

C. Barnstead GenPure™ Water Purification System

Able to mix and match UF, UV and TOC systems for user-specific water purity levels, the GenPure system produces up to 200 L/day of GLP-compliant Type 1 ultrapure water from a pretreated feed water supply. It is ideal for a broad range of life sciences and analytical chemistry processes.

| | Cat. # | \$/Each |
|-------------------------|----------------|-----------------|
| GenPure Water System | 1714-32 | 5,049.00 |
| GenPure UF Water System | 1714-33 | 5,507.00 |

(Includes Ultra-Filtration; ideal for molecular biology, microbiology, PCR, IVR and monoclonal antibody processes)

D. GenPure xCAD Water Purification System

Includes all the features of the GenPure system above, plus remote dispensing, electronic dosing capabilities, and flexible mounting options.

| | Cat. # | \$/Each |
|------------------------------|----------------|-----------------|
| GenPure xCAD Water System | 1714-48 | 5,890.00 |
| GenPure xCAD UF Water System | 1714-49 | 6,214.00 |

(Includes Ultra-Filtration; ideal for molecular biology, microbiology, PCR, IVR and monoclonal antibody processes)

E. LabTower™ TII Water Purification System

This system converts tap water into GLP-compliant Type 2 water; choose 20 L or 20 L/hr. models. This stand-alone unit with casters has an integrated 100 L tank that recirculates reservoir water to preserve purity even during periods of stagnation. Optional UV light eliminates bacteria. More configurations and specifications.

| | Cat. # | \$/Each |
|-------------------------------|----------------|-----------------|
| LabTower TII System, 20 L/hr. | 1108-50 | 8,327.00 |
| LabTower TII System, 40 L/hr. | 1108-52 | 9,076.00 |

F. LabTower EDI Water Purification System

Two stand-alone systems in one. These models produce either Type 1 (up to 200 L/day) or Type 2 (up to 500 L/day) purified water. Includes high-performance RO module with Electrodeionization (EDI) technology. Integrated 100-liter tank recirculates Type 2 water to optimize purity.

| | Cat. # | \$/Each |
|-------------------------------|----------------|------------------|
| LabTower EDI System, 15 L/hr. | 1714-60 | 11,546.00 |
| LabTower EDI System, 30 L/hr. | 1714-61 | 13,210.00 |

Heraeus™ Multifuge™ X3

3-Liter Capacity

The 3-liter Heraeus Multifuge X3 is ideal for high-throughput environments and takes up to 40% less benchtop space. With nearly twice the capacity for standard tubes compared to same-sized centrifuges, these energy saving models accommodate various swinging, fixed-angle and lightweight Fiberlite™ rotors.

- **Features:** 3-second rotor exchange; biocontainment solution; powersave; auto-correct detection
- Max Speed: 6000 to 15200 rpm (depending on rotor)
- Max RCF: 7164 to 25314 x g (depending on rotor)



Ventilated models have a low-profile design that takes up to 40% less benchtop space compared to other models.



Refrigerated models are ideal for temperature-sensitive processes in high-performance applications. CFC-free refrigeration systems have a temperature range of -10° to +40°C.



Transportable floor-standing model with an ergonomic height of 31.1" for easy reach of samples

Select models are UL, CE, or CSA certified

| 120V Models | Dimensions (W" x D" x H") | Cat. # | S/Each |
|------------------------------|---------------------------|----------------|------------------|
| Benchtop Models | | | |
| Ventilated | 22.2 x 26.4 x 14.2 | 3618-71 | 6,879.00 |
| Refrigerated | 29.3 x 26.4 x 14.2 | 3618-73 | 9,231.00 |
| Floor-Standing Models | | | |
| Ventilated | 22.2 x 26.4 x 54.5 | 3618-75 | 7,795.00 |
| Refrigerated | 22.2 x 26.4 x 31.1 | 3618-77 | 10,066.00 |



Heraeus Multifuge X1

1-Liter Capacity

As the only 1-liter centrifuge capable of spinning 14 x 50 ml conical tubes in angle configuration at over 12000 xg, the energy-saving Multifuge X1 accepts various swinging bucket, fixed-angle and lightweight Fiberlite rotors. **Features:** 3-second rotor exchange; biocontainment solution; powersave; and auto-correct detection.

- Select models are UL, CE, or CSA certified
- Max Speed/RCF: 15200 rpm/25999 x g;
- Ventilated: 17.3"W x 23.8"D x 14.2"H
- Refrigerated: 24.5"W x 23.8"L x 14.2"H

| 120V Models | Cat. # | S/Each |
|---------------|----------------|-----------------|
| Ventilated | 1538-52 | 4,921.00 |
| Refrigerated* | 1538-54 | 7,048.00 |

* Model shown



Heraeus Megafuge™ 8

4 x 145 ml to 6 x 50 ml Capacity

This compact centrifuge accepts a wide variety of swing-out and fixed-angle rotors ideal for clinical and research applications. **Features:** 3-second rotor exchange; biocontainment solution; powersave; and auto-correct detection.

- Select models are UL, CE and IVD listed
- Max Speed/RCF: 4500 rpm/ 3260 x g
- Ventilated: 14.6"W x 18.9"D x 12.2"H

| 120V Models | Cat. # | S/Each |
|-------------|----------------|-----------------|
| Ventilated | 1716-01 | 2,188.00 |



Heraeus Clinifuge™

12 x 15 ml Capacity

Ideal for clinical blood sample processing in small labs and medical practices, units also display error faults, an autoclavable rotor, and accepts a wide range of adapters. Rotor chambers are completely sealed during centrifugation and the brushless motor eliminates replacement of carbon brushes.

- CSA Certified
- Max Speed/RCF: 5000 rpm /2600 x g
- Dimension: 11.2"W x 14.8"D x 9.5"H

| 120V Models | Cat. # | S/Each |
|-------------|----------------|-----------------|
| Ventilated | 1798-58 | 1,579.00 |

-  **Thousands of Items in Stock**
Popular models of both Terra-built and distributed products are inventoried for quick shipment – look for blue prices at TerraUniversal.com
-  **Order and Quote Carts**  Items priced in blue usually ship in 1-3 days.
Online ordering requests for hundreds of stocked items ready for immediate shipping
Online quote requests for made-to-order and custom products,
-  **Low-Cost Domestic and International Shipping**
Competitive quotes include customs brokerage and duties for door-to-door delivery
-  **Hassle-Free Pricing**
Web prices honored worldwide
-  **Comprehensive Product Lines**
 Terra provides single-source convenience at remarkable savings. Complete lines of laboratory products at Laboratory-Equipment.com
-  **Global Network of Sales Representatives**
Complete listing at TerraUniversal.com